

- 10 4110 Lokgehäuse
- 13 4000 Lampenglas
- 16 4000 Beschwerung

34 4110 Kuppellasche

40 4110 Fahrgestell kompl. ohne Motor ohne Beschwerung

42 4110 Steuerung kompl. einschl. Verbundstange
43 4000 Zylinderkasten

50 4001 Motor
53 4001 Radsatz ohne Zahnrad
53 4015 Radsatz mit Zahnrad
54 4001 Haftring
56 7604 Schnecke

61 4908 Stromabnahmefeder
64 4101 Drossel
64 4202 Kondensator
64 4402 Kontaktpilzgarnitur
65 4003 Schaltplatte

70 0403 Schraube
71 3513 Schraube
73 0501 Splint mit 6-kt.
73 0502 Splint ohne 6-kt.
75 4006 Puffer

6521 Kupplung

534902 achshalter

40 4110

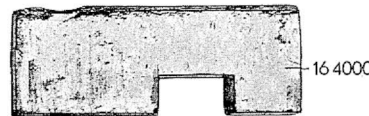
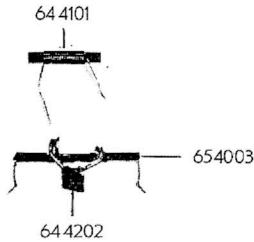
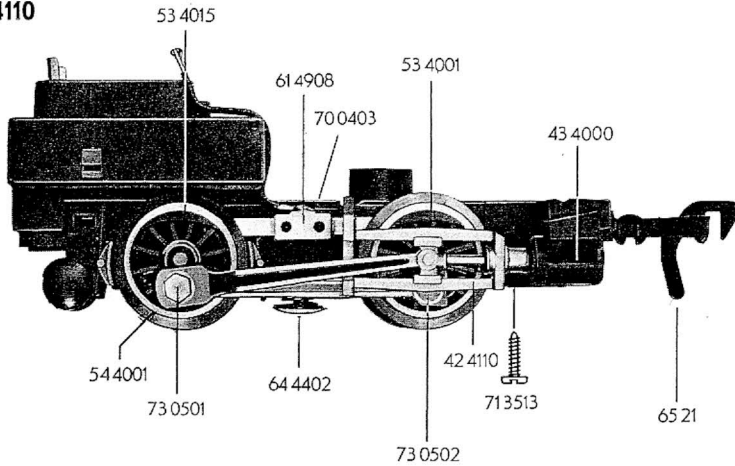

50 4001

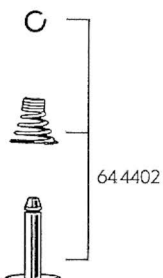
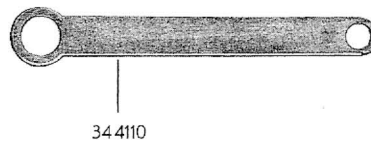
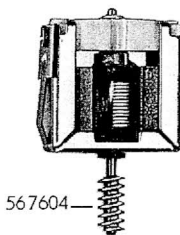

4110 FLEISCHMANN

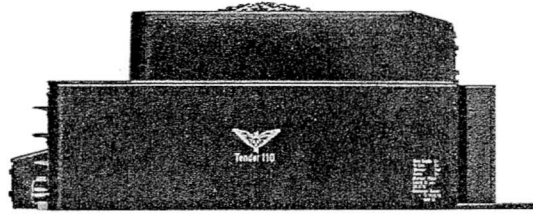

20 4110

20 4110 Tendergehäuse

41 4110 Tenderbodenrahmen

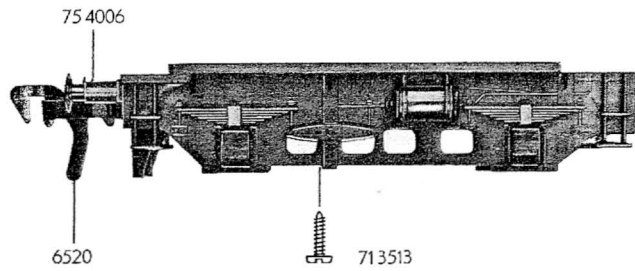

414110

53 4014 Tenderradsatz

71 3513 Schraube
73 0503 Splint (ohne Bild)
75 4006 Puffer

6520 Kupplung

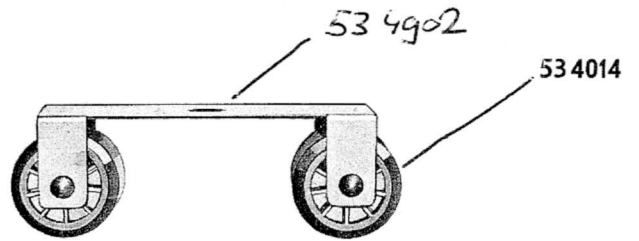

4110 FLEISCHMANN