

Motorwagen / Motor coach

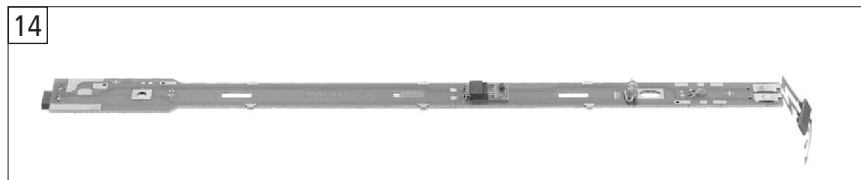

15 o. Abb. / no ill.
DCC-DECODER ZIMO Mx630
DCC-Decoder Zimo Mx630

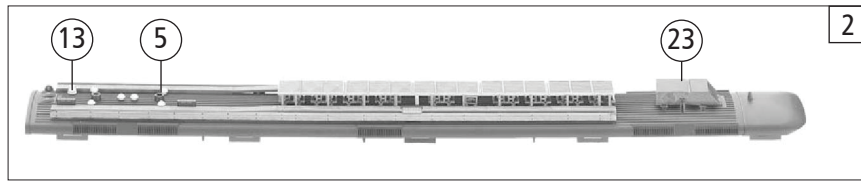
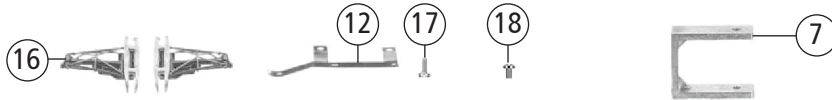
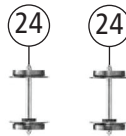
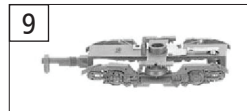
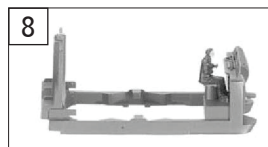
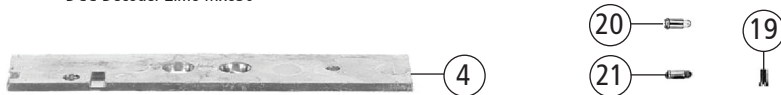

10 o. Abb. / no ill.
UNTERLEGSCH. 2,3 X 5 X 0,1
Washer

11 o. Abb. / no ill.
UNTERLEGSCH. ROT 2,2X5X0,3
Washer, red

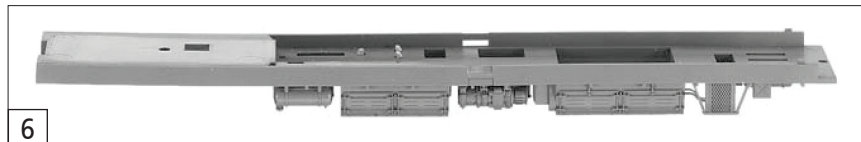

Pos. Nr. Pos.no.	Beschreibung Description	Art.-Nr. Art.no.	Preisgruppe Price bracket
1	GEHÄUSE KPL.F.TRIEBW.M.MOTOR Motor coach body	10447103	034
2	DACH KPL.FÜR TRIEBWAGEN MIT MO Roof, complete for motor coach	12447103	024
3	FLÜCHTLEITER-SATZ Light conductor set	00134470	013
4	BESCHWERUNG Ballast	00164438	016
5	TRAVERSEN-SATZ FÜR EINHOLMSTROMAB. Pantograph insulator set	00174470	012
6	WAGENBODEN U.KOMPRESSOR Floor plate for motor coach	00304471	017
7	BUEGEL FINNENBELEUCHTUNG Illumination coach plate	00354430	009
8	ANTRIEBSRAHMEN MIT LOKFUEHRER Motor bogie cpl. with loco driver	00454470	020
9	DREHGESTELL F. TRIEBWAGEN M. M Rear bogie for motor coach	00471471	014
10	UNTERLEGSCH. 2,3 X 5 X 0,1 (o. Abb.) Washer (no ill.)	00564747	001
11	UNTERLEGSCH. ROT 2,2X5X0,3 (o. Abb.) Washer, red (no ill.)	00564751	001
12	STROMABNEHMERFEDER Power pick-up spring	00614948	002
13	UMSCHALTER MIT SCHALTFEDER Switch with switch spring	00644470	009
14	SCHALTPLATTE F. PLAN Y-SPRINTER PCB for Plan Y-Sprinter	65417100	---
15	DCC-DECODER ZIMO Mx630 (ohne Abb.) DCC-Decoder Zimo Mx630 (no ill.)	68397102	041
16	EINHOLMSTROMABNEHMER Single arm pantograph	67433200	018
17	SCHRAUBE Screw	00700307	001
18	SCHRAUBE Screw	00700604	001
19	LINSENSCHRAUBE Lenses screw	00730003	001
20	ERS. -GLUEHLAMPE KLAR M. STECKFA Replacement bulb, clear, with plug in socket	00006535	008
21	ERS. -GLUEHLAMPE ROT M. STECKFSS Replacement bulb, red, with plug in socket	00009531	009
22	FENSTER -SATZ Window set	00144471	018
23	KÜHLKASTEN Cool box	00194622	008
24	AUSTAUSCH-RADSATZ 25MM Exchange wheel set 25mm	6561	---

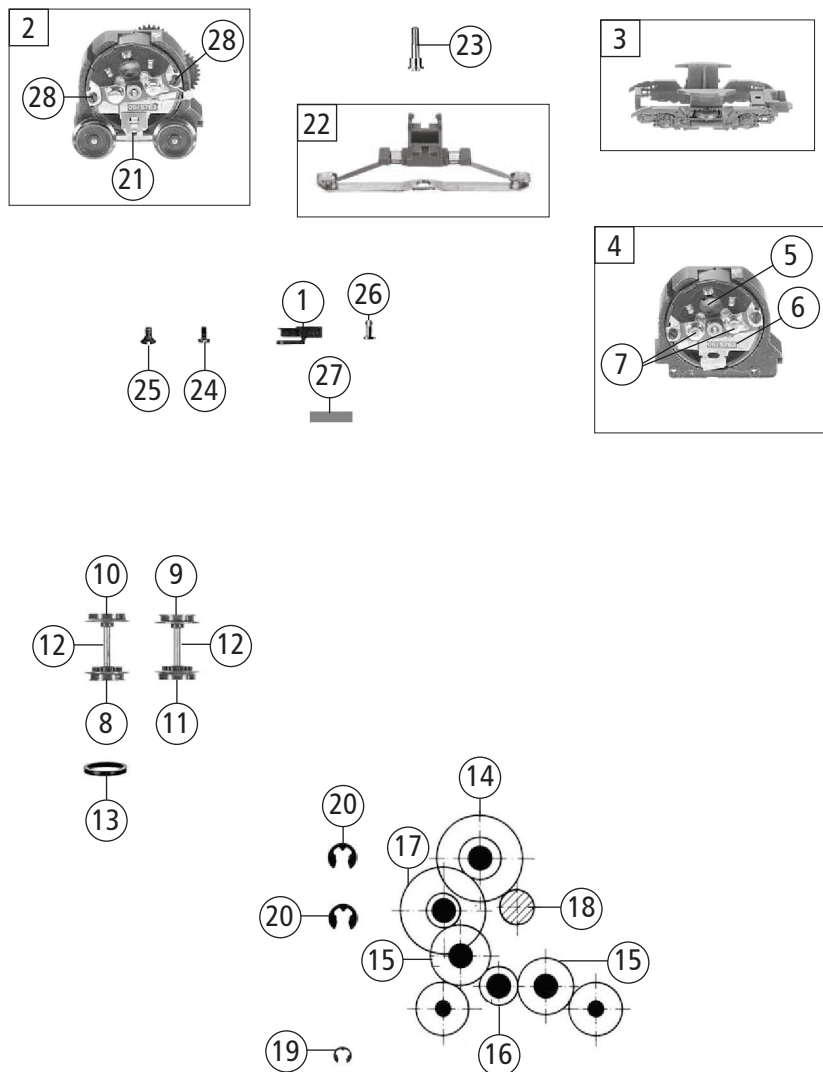

Pos. Nr. Pos.no.	Beschreibung Description	Art.-Nr. Art.no.	Preisgruppe Price bracket
397103	NS 2001	==	H0
1	KUPPLUNGSADAPTER Coupling adaptor	00384001	006
2	MOTORDREHGESTELL M. SCHWUNGMASSE Motor bogie complete with flywheel	40397102	035
3	DREHGESTELLRAHMEN Bogie framework	00414470	011
4	MOTOR MIT SCHWUNGMASSE Motor with swing mass	50447102	033
5	ANKER KPL.M.SCHWUNGMASSE Rotor	00504607	025
6	LAGERSCHILD ISOLIERT Motor PCB, insulated	50474400	019
7	KOHLLENROHRKAPPE Brush pipe cap	00504801	002
8	LOKRAD M.Z.M.N.UGR. Loco wheel with gear, with tr. tyre	00514259	007
9	LOKRAD O.Z.M.N.UGR. Loco wheel w/o gear, with tr. tyre	00514260	007
10	LOKRAD O.Z.O.N.UGR. Loco wheel w/o gear, w/o tr. tyre	00514261	007
11	LOKRAD M.Z.O.N.UGR. Loco wheel with gear, w/o tr. tyre	00514262	007
12	ACHSE GERAENDELT 20 MM Milled axle, 20mm	00524006	002
13	HAFTREIFEN HO Traction tyre	00544007	001
14	UNTERSETZUNGSRAD Z:28/13 SCHWARZ Reduction gear wheel Z:28/13, black	00564102	002
15	ZWISCHENRAD Z:18 SCHWARZ Gear wheel Z:18, black	00564105	002
16	ZWISCHENRAD Gear wheel	00564106	002
17	UNTERSETZUNGSRAD Z:32/13 SCHWARZ Reduction gear wheel Z:32/13, black	00564107	002
18	RITZEL Z:10 Gear wheel	00564602	004
19	SICHERUNGSRING KLEIN Securing ring, small	00564701	001
20	SICHERUNGSRING GROSS Securing ring, big	00564702	001
21	MOTORSTROMABNEHMER Motor contact clip	00614916	002
22	SCHLEIFER Slider	69202800	014
23	ZAPFENSCHRAUBE FÜR HO WAGEN Flanged bolt	00730027	002
24	SCHRAUBE Screw	00700404	001
25	SCHRAUBE M2 x 3-4,8 H DIN 965 Screw M2 x 3-4,8 H DIN 965	00702403	001
26	SPLINT F. KUPPLUNGSADAPT Split pin for coupling adaptor	00730525	001
27	BLATTTRICHTFEDER L=9,5MM Flat straightening spring L=9,5mm	00764007	001
28	SCHRAUBE Screw	00700313	001
	STECKKUPPLUNG (o. Abb.) Coupling (w/o illust.)	6509	---
	STECK-TAUSCHKUPPLUNG (o. Abb.) Plug-exchange coupling (w/o illust.)	6511	---
	PROFI-STECKKUPPLUNG (o. Abb.) Profi-coupling (w/o illustr.)	6515	---
	ERSATZ-SCHLEIFKOHLEN (o. Abb.) Carbon brushes (w/o illustr.)	6519	---

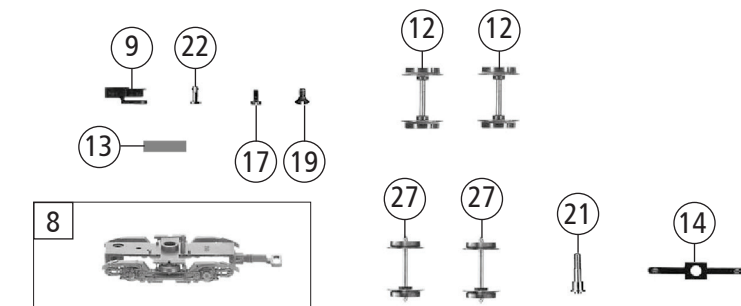
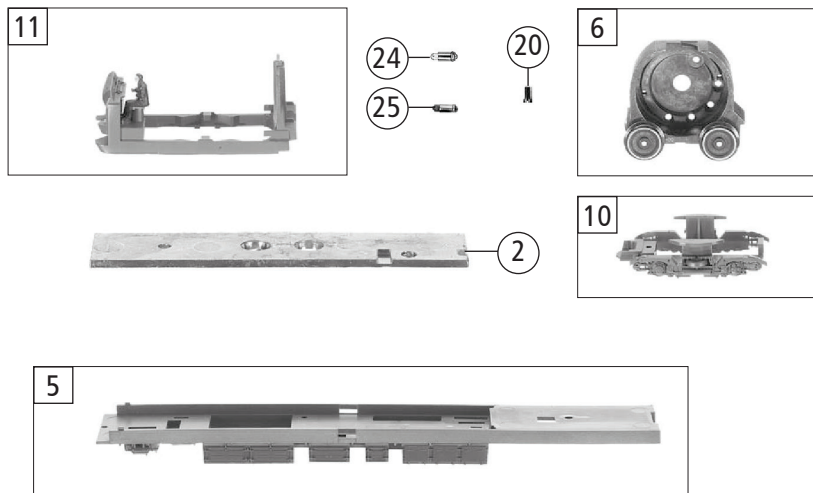
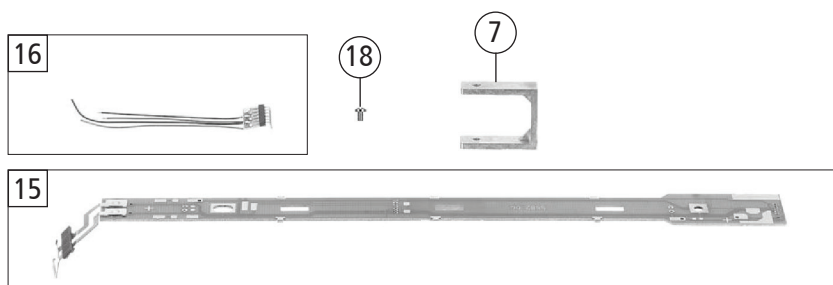
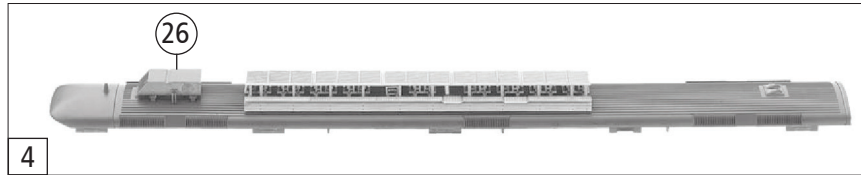
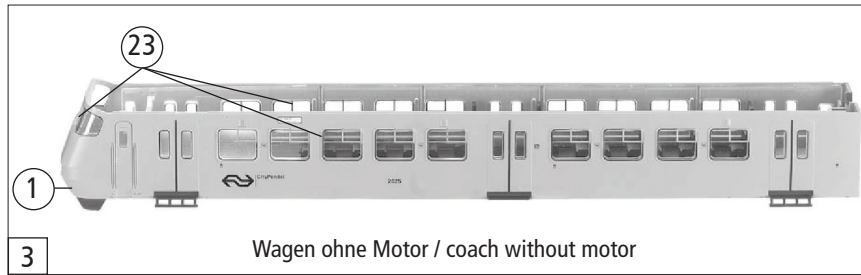

Pos. Nr. Pos.no.	Beschreibung Description	Art.-Nr. Art.no.	Preisgruppe Price bracket
1	FLUTLICHTLEITER -SATZ Light conductor set	00134470	013
2	BESCHWERUNG Ballast	00164438	016
3	GEHÄUSE KPL.FÜR TRIEBWAGEN OHN Non motorized coach body	20447103	034
4	DACH KPL.F. TRIEBWAGEN O. MOTOR Roof for no motorized coach body	22447103	020
5	WAGENBODEN MIT BATTERIEKASTEN Floor plate for non motorized coach body	00304470	018
6	DREHGESTELLBLOCK OHNE MOTOR U. Motor bogie block	00314470	021
7	BUEGEL FINNENBELEUCHTUNG Illumination contact plate	00354430	009
8	DREHGESTELL FÜR TRIEBWAGEN OHN Bogie framework with contacts	00374471	012
9	KUPPLUNGSADAPTER Coupling adaptor	00384001	006
10	DREHGESTELLRAHMEN Bogie framework (front)	00414470	011
11	ANTRIEBSRAHMEN MIT LOKFUEHRER Interior fitting/bogie reception with driver	00454470	020
12	LOKRAD O.Z.O.N.UGR. Loco wheel w/o gear, w/o tr. tyre	00514261	007
13	BLATTRICHTFEDER L=9,5MM Flat straightening spring L=9,5mm	00764007	001
14	BELEUCHTUNGSFEDER H0 Light contact spring H0	00614919	002
15	SCHALTPLATTE KPL. FÜR TRIEBWAGEN PCB for non-motorized coach	65417200	---
16	6-POL.STECKERPLATINE MIT LITZE 6-pin plug with cables	00654085	020
17	SCHRAUBE Screw	00700404	001
18	SCHRAUBE Screw	00700604	001
19	SCHRAUBE M2 x 3-4,8 H DIN 965 Screw M2 x 3-4,8 H DIN 965	00702403	001
20	LINSENSCHRAUBE Lenses screw	00730003	001
21	ZAPFENSCHRAUBE F. HO WAGEN Flanged bolt	00730027	002
22	SPLINT F. KUPPLUNGSADAPTER Split pin for coupling adaptor	00730525	001
23	FENSTER -SATZ Window set	00144471	018
24	ERS. -GLUEHLAMPE KLAR M: STECKFA Replacement bulb, clear, with plug in socket	00006535	008
25	ERS. -GLUEHLAMPE ROT M: STECKFSS Replacement bulb, red, with plug in socket	00009531	009
26	KÜHLKASTEN Cool box	00194622	008
27	AUSTAUSCH-RADSATZ 25MM Exchange wheel set 25mm	6561	---
	STECKKUPPLUNG (o. Abb.) Coupling (w/o illustr.)	6509	---
	STECK-TAUSCHKUPPLUNG (o. Abb.) Plug-exchange coupling (w/o illustr.)	6511	---
	PROFI-STECKKUPPLUNG (o. Abb.) Profi-coupling (w/o illustr.)	6515	---

Ersatzteile erhalten Sie direkt unter www.fleischmann.de, bei Ihrem Fachhändler, oder Ihrer Landesvertretung.
Spare parts can be ordered directly at www.fleischmann.de and from your local dealer or country representative.