

Motorwagen / Motor coach

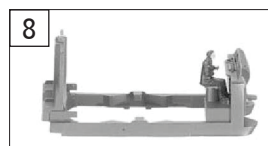

10 o. Abb. / no ill.
UNTERLEGSCH. 2,3 X 5 X 0,1
Washer

11 o. Abb. / no ill.
UNTERLEGSCH. ROT 2,2X5X0,3
Washer, red

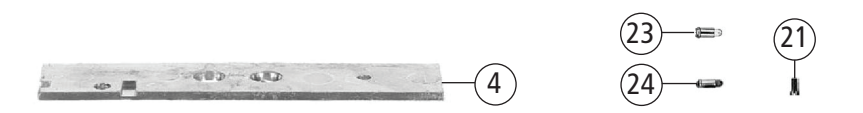
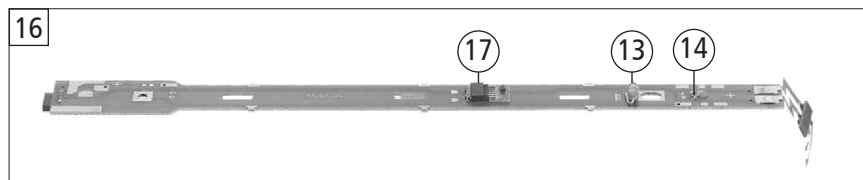
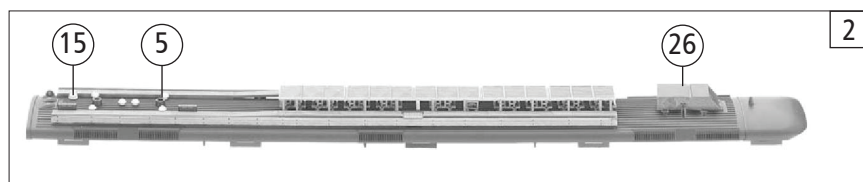
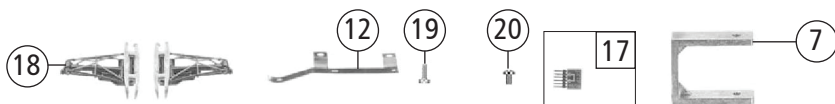
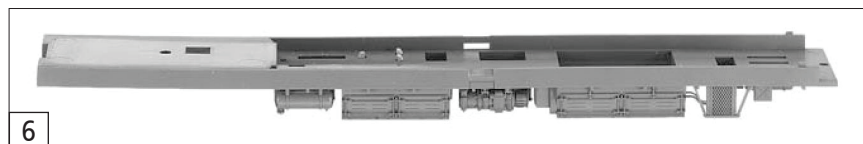

Pos. Nr. Pos.no.	Beschreibung Description	Art.-Nr. Art.no.	Preisgruppe Price bracket
1	GEHÄUSE KPL. F. TRIEBWAG. MIT MOTOR Motor coach body	10447103	034
2	DACH KPL. FÜR TRIEBWAGEN MIT MOTOR Roof, complete for motor coach	12447103	024
3	FLUTLICHTLEITER-SATZ Light conductor set	00134470	013
4	BESCHWERUNG Ballast	00164438	016
5	TRAVERSEN-SATZ FÜR EINHOLMSTROMAB. Pantograph insulator set	00174470	012
6	WAGENBODEN U.KOMPRESSOR Floor plate for motor coach	00304471	017
7	BUEGEL FINNENBELEUCHTUNG Illumination coach plate	00354430	009
8	ANTRIEBSRAHMEN MIT LOKFUEHRER Motor bogie cpl. with loco driver	00454470	020
9	DREHGESTELL F. TRIEBWAGEN M. MOTOR Rear bogie for motor coach	00474470	018
10	UNTERLEGSCH. 2,3 X 5 X 0,1 (o. Abb.) Washer (no ill.)	00564747	001
11	UNTERLEGSCH. ROT 2,2X5X0,3 (o. Abb.) Washer, red (no ill.)	00564751	001
12	STROMABNEHMERFEDER Power pick-up spring	00614948	002
13	ENTSTOERDROSSEL (MAERKLIN) Suppressor choke	00644102	005
14	KONDENSATOR Capacitor	64420900	005
15	UMSCHALTER MIT SCHALTFEDER Switch with switch spring	00644470	009
16	SCHALTPLATTE FÜR PLAN Y-SPRINTER PCB for Plan Y-Sprinter	00654083	031
17	SCHNITTST.-BLINDSTECKER 6-POL. Jumper 6-pin	00664002	013
18	EINHOLMSTROMABNEHMER Single arm pantograph	67433200	018
19	SCHRAUBE Screw	00700307	001
20	SCHRAUBE Screw	00700604	001
21	LINSENSCHRAUBE Lenses screw	00730003	001
22	ZAPFENSCHRAUBE F.HO WAGEN Flanged bolt	00730027	002
23	ERS.-GLUEHLAMPE KLAR M: STECKFA Replacement bulb, clear, with plug in socket	00006535	008
24	ERS.-GLUEHLAMPE ROT M. STECKFSS Replacement bulb, red, with plug in socket	00009531	009
25	FENSTER -SATZ Window set	00144471	018
26	KÜHLKASTEN Cool box	00194622	008
27	RADSATZ EINS. ISO 25MM Wheelset, single side insulated	00534009	007

Änderungen in Konstruktion und Ausführung vorbehalten
We reserve the right to change the construction and specification

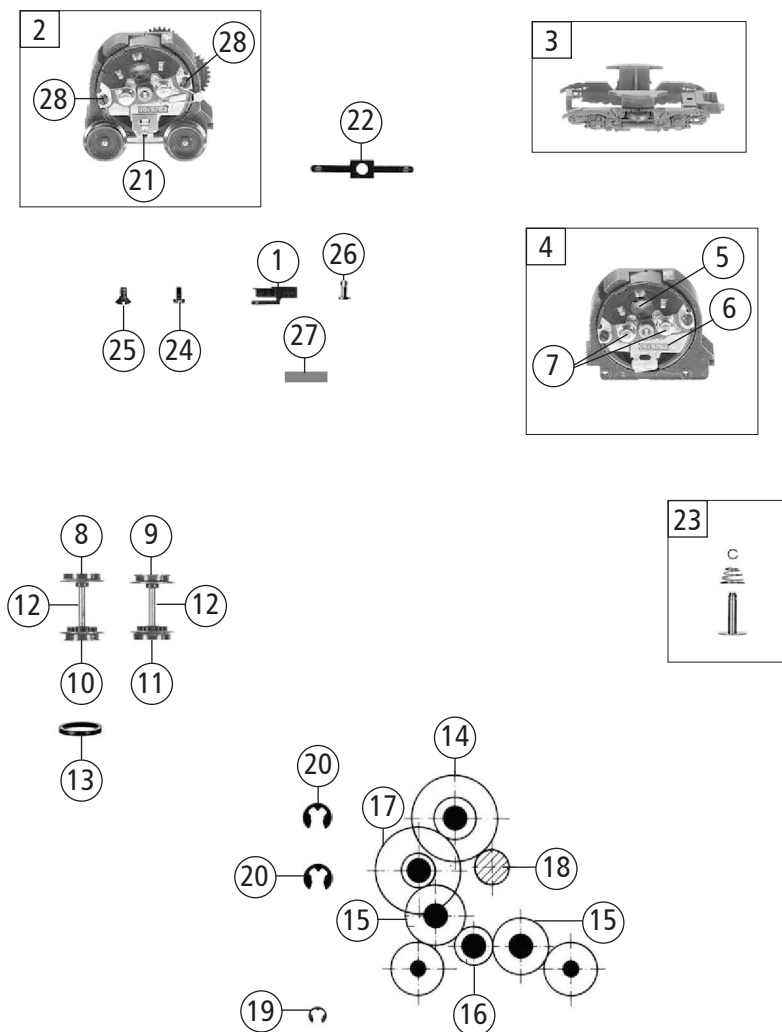

447103	NS	2001	==	H0
Pos. Nr. Pos.no.	Beschreibung Description		Art.-Nr. Art.no.	Preisgruppe Price bracket
1	KUPPLUNGSADAPTER Coupling adaptor		00384001	006
2	DREHGESTELLBLOCK MIT MOTOR OHN Motor bogie complete with flywheel		40447102	035
3	DREHGESTELLRAHMEN Bogie framework		00414470	011
4	MOTOR MIT SCHWUNGMASSE Motor with swing mass		50447102	033
5	ANKER KPL.MIT SCHWUNGMASSE Rotor		00504607	025
6	LAGERSCHILD ISOLIERT Motor PCB, insulated		50474400	019
7	KOHLENROHRKAPPE Brush pipe cap		00504801	002
8	L.RAD O.Z.O.N.ISO Loco wheel w/o gear, w/o trac. tyre, insulated		00514182	006
9	L.RAD O.Z.M.N.ISO. Loco wheel w/o gear, with tr. tyre, insulated		00514183	006
10	L.RAD M.Z.M.N. Loco wheel with gear, with tr. tyre		00514209	007
11	L.RAD M.Z.O.N. Loco wheel with gear, w/o tr. tyre		00514232	007
12	ACHSE GERAENDELT 20 MM Milled axle, 20mm		00524006	002
13	HAFTREIFEN H0 Traction tyre		00544007	001
14	UNTERSETZUNGSRAD Z:28/13 SCHWARZ Reduction gear wheel Z:28/13, black		00564102	002
15	ZWISCHENRAD Z:18 SCHWARZ Gear wheel Z:18, black		00564105	002
16	ZWISCHENRAD Gear wheel		00564106	002
17	UNTERSETZUNGSRAD Z:32/13 SCHWARZ Reduction gear wheel Z:32/13, black		00564107	002
18	RITZEL Z:10 Gear wheel		00564602	004
19	SICHERUNGSRING KLEIN Securing ring, small		00564701	001
20	SICHERUNGSRING GROSS Securing ring, big		00564702	001
21	MOTORSTROMABNEHMER Motor contact clip		00614916	002
22	BELEUCHTUNGSFEDER H0 Light contact spring H0		00614919	002
23	KONTAKTPILZGARNITUR L:10 MM Contacter pin assembly		00644407	011
24	SCHRAUBE Screw		00700404	001
25	SCHRAUBE M2 x 3-4,8 H DIN 965 Screw M2 x 3-4,8 H DIN 965		00702403	001
26	SPLINT FÜR KUPPLUNGSADAPTER Split pin for coupling adaptor		00730525	001
27	BLATTRICHTFEDER L=9,5MM Flat straightening spring L=9,5mm		00764007	001
28	SCHRAUBE Screw		00700313	001
	STECKKUPPLUNG (o. Abb.) Coupling (w/o illust.)		6509	---
	STECK-TAUSCHKUPPLUNG (o. Abb.) Plug-exchange coupling (w/o illust.)		6511	---
	PROFI-STECKKUPPLUNG (o. Abb.) Profi-coupling (w/o illustr.)		6515	---
	ERSATZ-SCHLEIFKOHLEN (o. Abb.) Carbon brushes (w/o illustr.)		6519	---

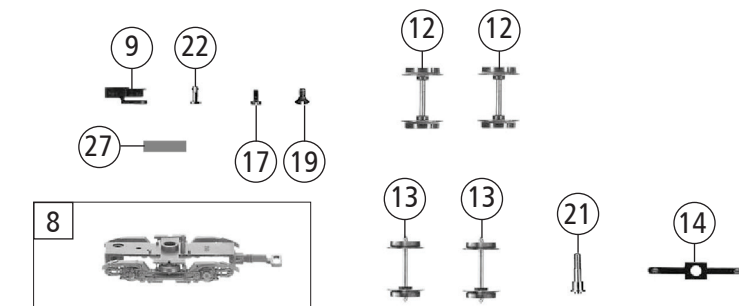
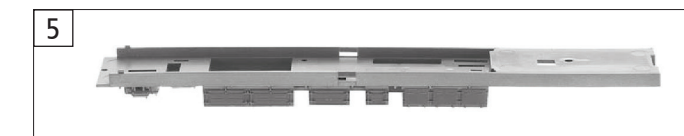
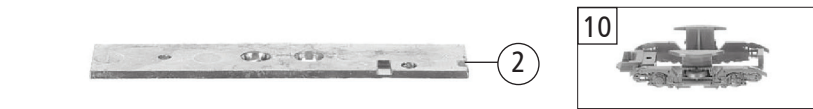
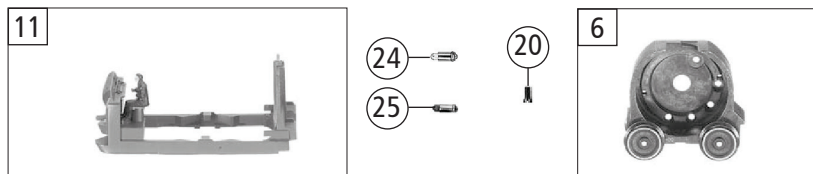
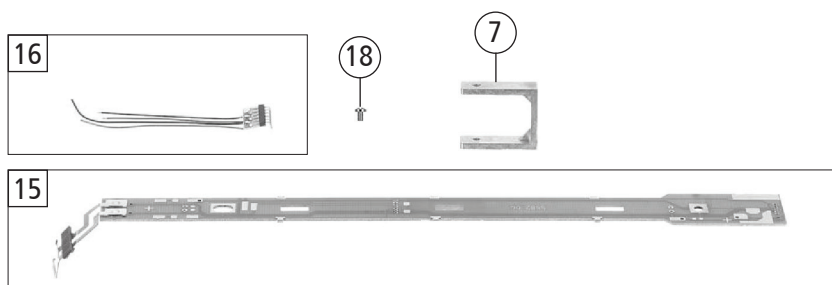
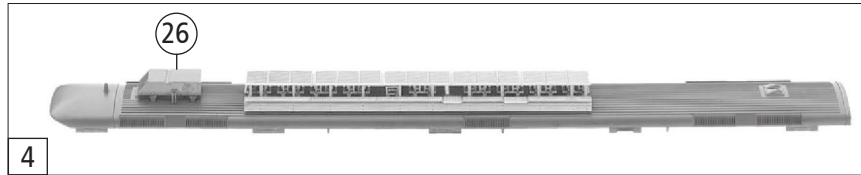
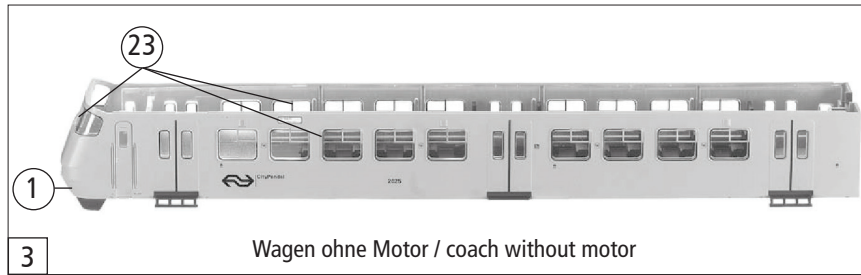

Pos. Nr. Pos.no.	Beschreibung Description	Art.-Nr. Art.no.	Preisgruppe Price bracket
1	FLUTLICHTLEITER -SATZ Light conductor set	00134470	013
2	BESCHWERUNG Ballast	00164438	016
3	GEHÄUSE KPL.FÜR TRIEBWAGEN OHN Non motorized coach body	20447103	034
4	DACH KPL.F. TRIEBWAGEN O.MOTOR Roof for no motorized coach body	22447103	020
5	WAGENBODEN MIT BATTERIEKASTEN Floor plate for non motorized coach body	00304470	018
6	DREHGESTELLBLOCK OHNE MOTOR U. Motor bogie block	00314470	021
7	BUEGEL FINNENBELEUCHTUNG Illumination contact plate	00354430	009
8	DREHGESTELL FÜR TRIEBWAGEN OHN Bogie framework with contacts	00374471	012
9	KUPPLUNGSADAPTER Coupling adaptor	00384001	006
10	DREHGESTELLRAHMEN Bogie framework (front)	00414470	011
11	ANTRIEBSRAHMEN MIT LOKFUEHRER Interior fitting/bogie reception with driver	00454470	020
12	L.RAD O.Z.O.N.ISO Loco wheel w/o gear, w/o tr. tyre, insulated	00514182	006
13	RADSATZ EINS.ISO 25MM Wheelset 25mm, single side insulated	00534009	007
14	BELEUCHTUNGSFEDER H0 Light contact spring H0	00614919	002
15	SCHALTPLATTE KPL.FÜR TRIEBWAGE PCB for non-motorized coach	00654084	022
16	6-POL.STECKERPLATINE MIT LITZE 6-pin plug with cables	00654085	020
17	SCHRAUBE Screw	00700404	001
18	SCHRAUBE Screw	00700604	001
19	SCHRAUBE M2 x 3-4,8 H DIN 965 Screw M2 x 3-4,8 H DIN 965	00702403	001
20	LINSENSCHRAUBE Lenses screw	00730003	001
21	ZAPFENSCHRAUBE F.HO WAGEN Flanged bolt	00730027	002
22	SPLINT F. KUPPLUNGSADAPT Split pin for coupling adaptor	00730525	001
23	FENSTER -SATZ Window set	00144471	018
24	ERS. -GLUEHLAMPE KLAR M. STECKFA Replacement bulb, clear, with plug in socket	00006535	008
25	ERS. -GLUEHLAMPE ROT M. STECKFSS Replacement bulb, red, with plug in socket	00009531	009
26	KÜHLKASTEN Cool box	00194622	008
27	BLATTRICHTFEDER L=9,5MM Flat straightening spring L=9,5mm	00764007	001
	STECKKUPPLUNG (o. Abb.) Coupling (w/o illust.)	6509	---
	STECK-TAUSCHKUPPLUNG (o. Abb.) Plug-exchange coupling (w/o illust.)	6511	---
	PROFI-STECKKUPPLUNG (o. Abb.) Profi-coupling (w/o illustr.)	6515	---
	ERSATZ-SCHLEIFKOHLEN (o. Abb.) Carbon brushes (w/o illustr.)	6519	---

Ersatzteile erhalten Sie direkt unter www.fleischmann.de, bei Ihrem Fachhändler, oder Ihrer Landesvertretung.
Spare parts can be ordered directly at www.fleischmann.de and from your local dealer or country representative.