

GLEIS-PLANE  
LAYOUT PLANS  
BAAN ONTWERPEN  
PLANS DE RÉSEAUX  
IMPIANTI FERROVIARI  
TRAZADOS DE VIAS  
RATAKAAVIOITA  
SPÅR-PLANER  
SPORPLANER

# M4



# FLEISCHMANN



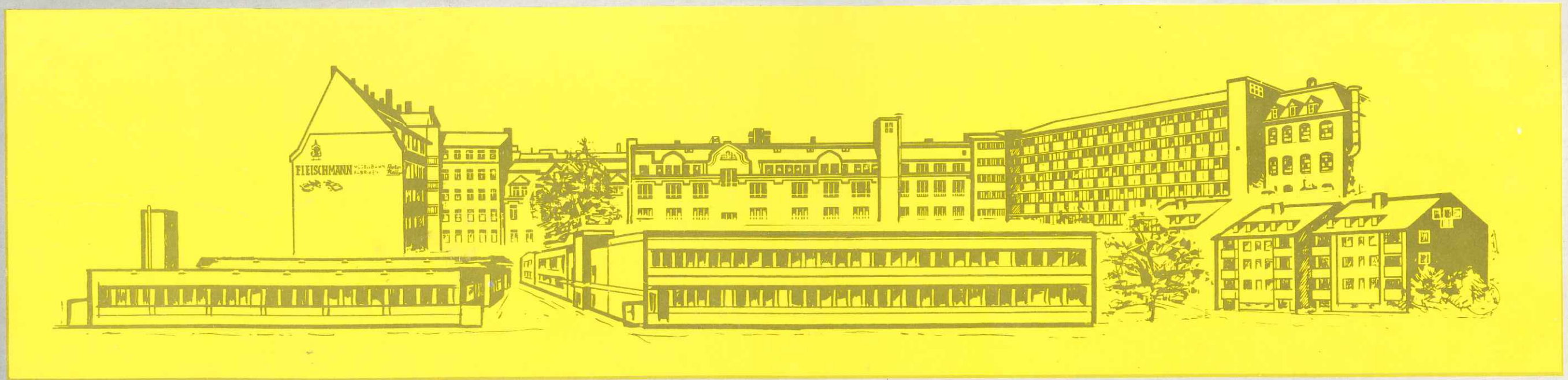

GEBR. FLEISCHMANN, DIREKTION 8500 NÜRNBERG/KIRCHENWEG 13, TELEFON (0911) 33 03 51



~~1,76 m~~

1,46 x m

0,76 m

# FLEISCHMANN

GLEIS-PLANE  
LAYOUT PLANS  
BAAN ONTWERPEN  
PLANS DE RÉSEAUX  
IMPIANTI FERROVIARI  
TRAZADOS DE VIAS  
RATAKAAVIOLTA  
SPÅR-PLANER  
SPORPLANER

# M4

# I

Gruppe  
Groepen  
Groupes  
Gruppo  
Grupo  
group  
Ryhmä  
Grupp  
Gruppe

Einzelteile el. Schaltungen einfache Gleis-Figuren Bahnhöfe  
Details elec. schakelingen eenvoudige railfiguren Stations  
Composantes Commandes électriques Dispositions de voies simplifiées. Gares  
Parti staccate Schemi elettrici Abbozzi di binari Stazioni  
Piezas sueltas Conexiones eléctricas Trazados sencillos de vías Estaciones  
parts electrical hook-up simple layout plans simple layout patterns stations  
Osat sähkökytkennät yksinkertaiset ratakaaviot Asemat  
Detaljer el. kopplingar enkla spårplaner Stationer  
Løsdele el. omskiftere lettere sporanlæg Banegårde

# II

Gruppe  
Groepen  
Groupes  
Gruppo  
Grupo  
group  
Ryhmä  
Grupp  
Gruppe

Anlagen-Pläne — einfach, mittelgroß, groß — flach in verschiedenen Ebenen — mit Verdrahtung  
Baanontwerpen eenvoudig, middelgroot, groot, vlak. in verschillende etages met bedrading  
Plans de réseaux simples, moyens, grands, étendus. à différents niveaux avec câblage  
Schemi di impianti semplici, di media grandezza, grandi, in piano, a diverse altitudini con collegamento elettrico  
Planos de maquetas sencillas, medianas, grandes, a un solo nivel, a varios niveles con conexiones  
layout plans simple, medium-size, large, single-level on several levels with wiring  
Ratakaavioita, yksinkertaisia, keskisuuria, suuria, matalia eri tasoissa johdotettuna johdotettuna  
Anläggningar enkla, medelstora, stora, plana i olika plan med kopplingar  
Anlægs-planer, let, mellemstor, stor, flad med niveauforskelle med strømskema

# III

Gruppe  
Groepen  
Groupes  
Gruppo  
Grupo  
group  
Ryhmä  
Grupp  
Gruppe

Automatische Anlagen (Kehrschleifen, Gleis-Dreiecke, Abstell-Bahnhöfe) mit Verdrahtung  
Automatische banen (keerlussen, railedriehoek, rangeerterreinen) met bedrading  
Réseaux automatiques (boucles de retournements, triangles, gares de remisage).  
Impianti automatici (racchetta, triangolo di binari, stazioni di deposito)  
Maquetas automáticas (bucles de retorno, triángulos de vías, estaciones apartadero) con conexiones  
automatic layouts (reversing loops, wyes, storage yards) with wiring  
Automaattiradat (Paluusilmukat, raidekolmiot, sivuraideautomaatiikka)  
Automatiska anläggningar (vändslingor, spårtrianglar, uppställningsbangårdar) med kopplingar  
Automatiske anlæg (køresløjfer, spor-trekanter, rangerbanegårde) med strømskema

Einzelteile	el. Schaltungen	einfache Gleis-Figuren	Bahnhöfe	
Details	elec. schakelingen	eenvoudige railfiguren	Stations	
Composantes	Commandes électriques	Dispositions de voies simplifiées.	Gares	
Parti staccate	Schemi elettrici	Abbozzi di binari	Stazioni	
Piezas sueltas	Conexiones eléctricas	Trazados sencillos de vías	Estaciones	
parts	electrical hook-up	simple layout plans	simple layout patterns	stations
Osat	sähkökytkennät	yksinkertaiset ratakaaviot	Asemat	
Detaljer	el. kopplingar	enkla spårplaner	Stationer	
Løsdele	el. omskiftere	lettere sporanlæg	Banegårde	



Gleise  
rails  
rails  
binari  
track sections  
skenan

1700 · 1900	1701 · 1901
1700/2 · 1900/2	1701/2 · 1901/2
1700/4 · 1900/4	1701 1/2 · 1901 1/2
1700/5 · 1900/5	1701/3 · 1901/3
1710 · 1910	1703 · 1903
1700/2 E · 1900/2 E	1703 1/2 · 1903 1/2
1700/2 EM · 1900/2 EM	1706 · 1906
1700/2 MS · 1900/2 MS	
1788 · 1988	

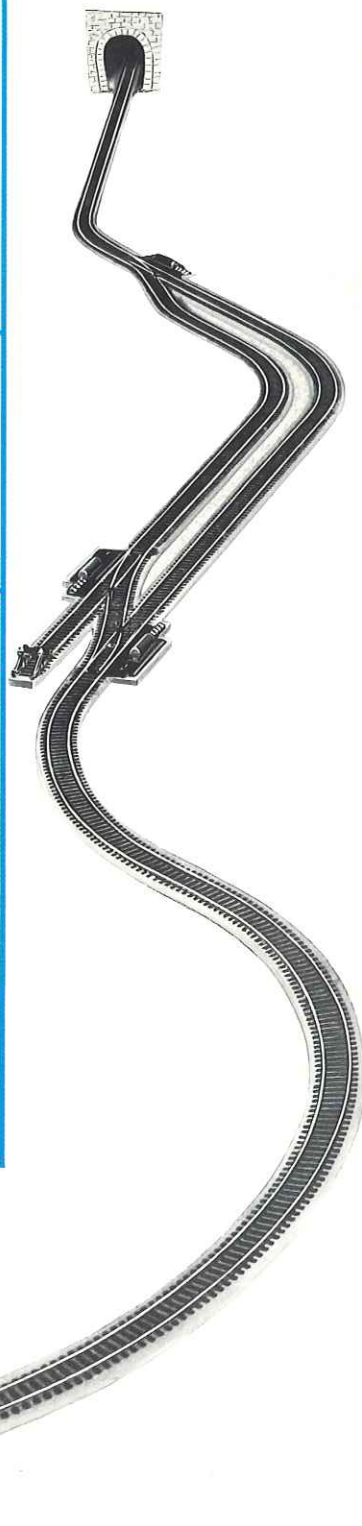

1722 · 1922	1721 · 1921
1724	1723
1724 A · 1924 A	1723 A · 1923 A
1726 A · 1926 A	
1711 · 1911	1712 · 1912
1725 · 1925	1725 A · 1925 A
<p>89 M</p>	

60	1700/2K	
61	1700/2SN	
62	1700/2T 1700/4T 1700/4U	
78		
<p>120mm 80mm 1710 · 1910</p>		
85	64	65

**VARIO**  
SYSTEM

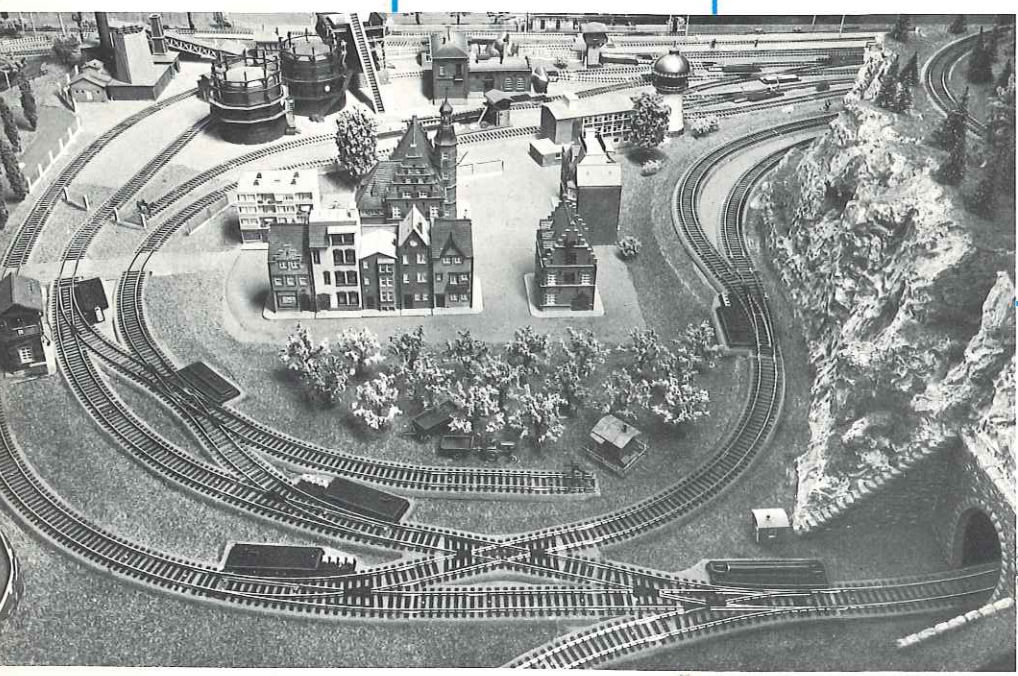

88

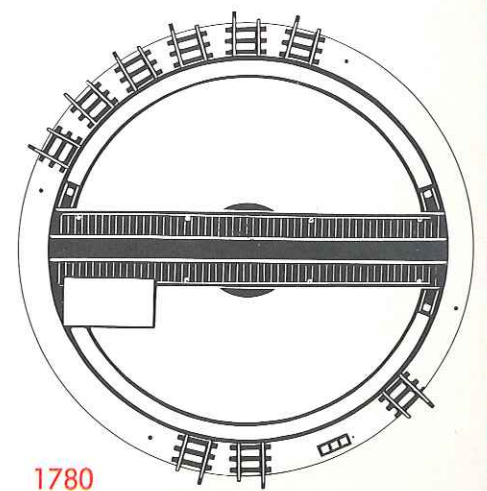
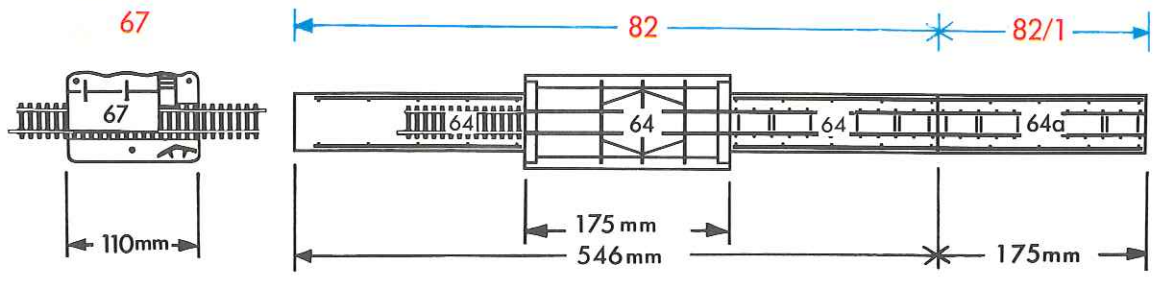

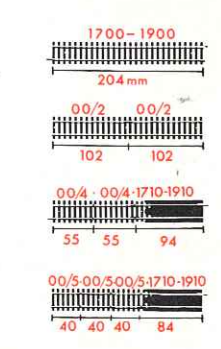
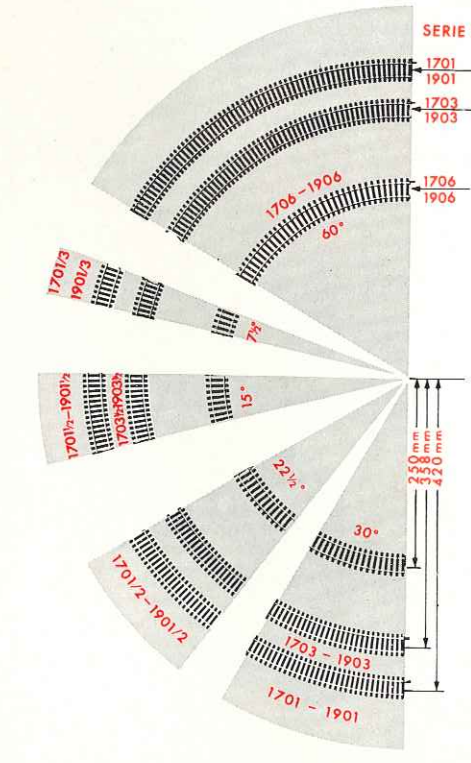
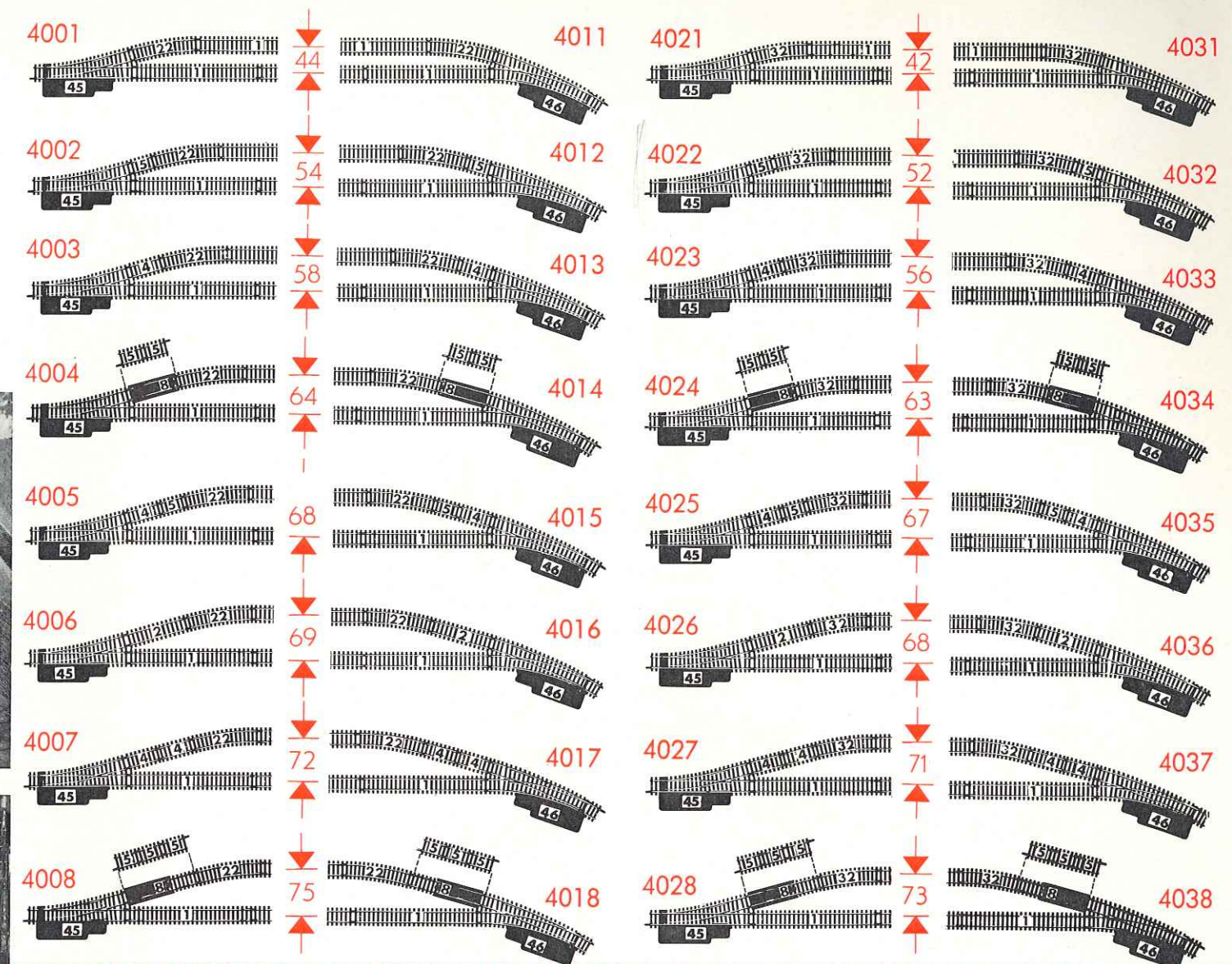
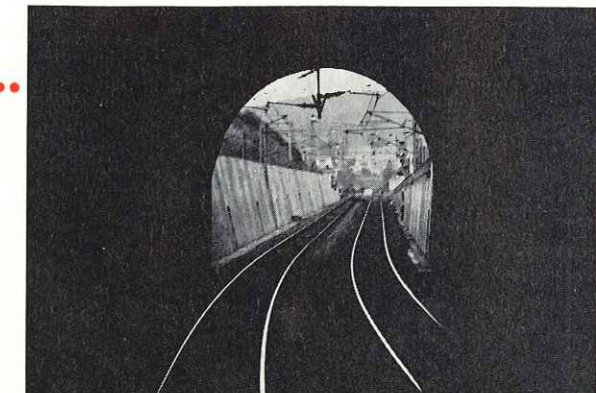
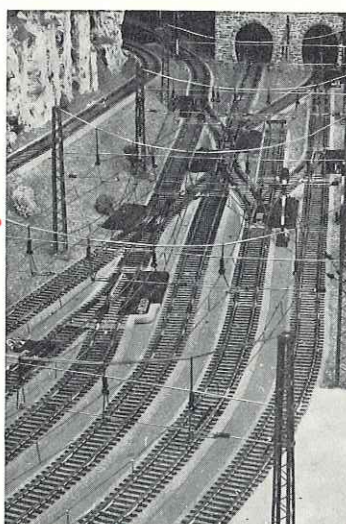
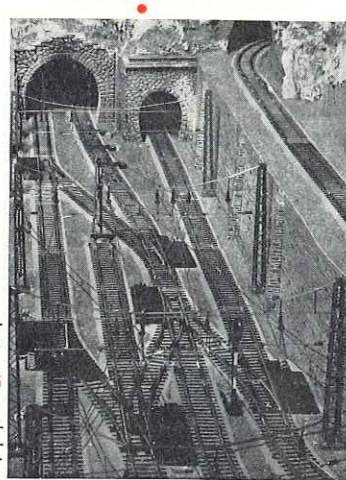
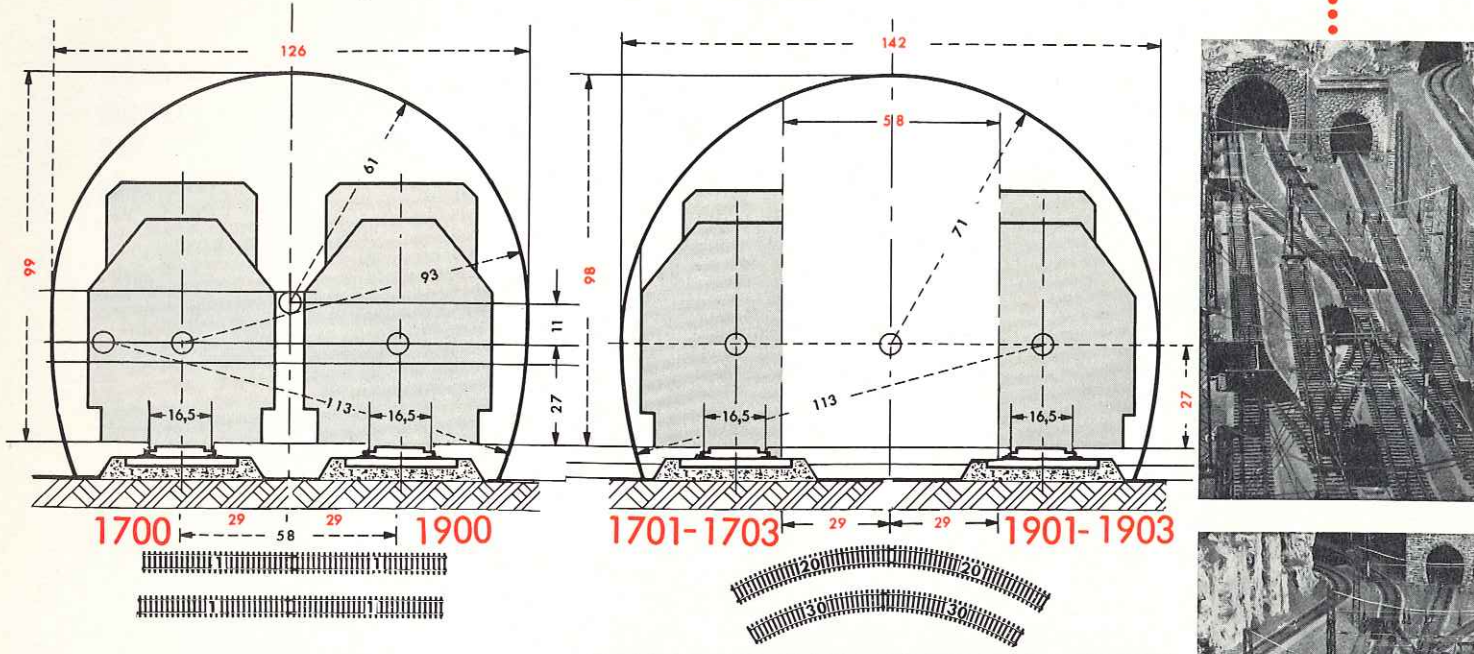
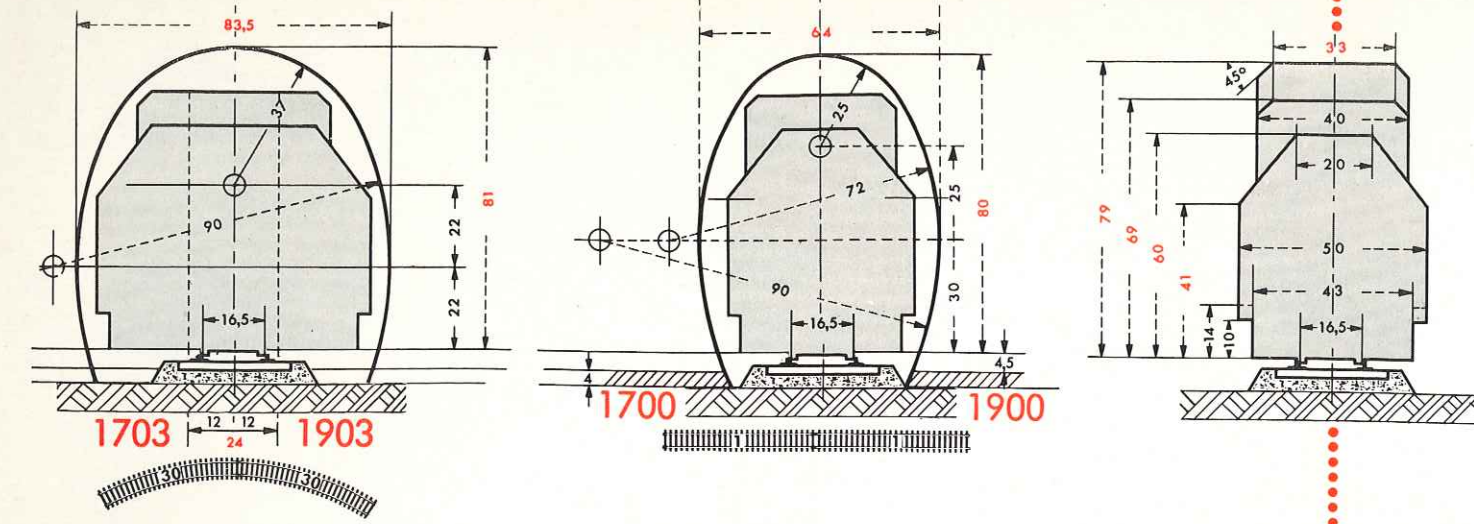

Gleisabstände  
 spoorabstande  
 entre-voies  
 interbinari  
 distance between tracks  
 spårvidd

**M**  
 4001  
 —  
 4046

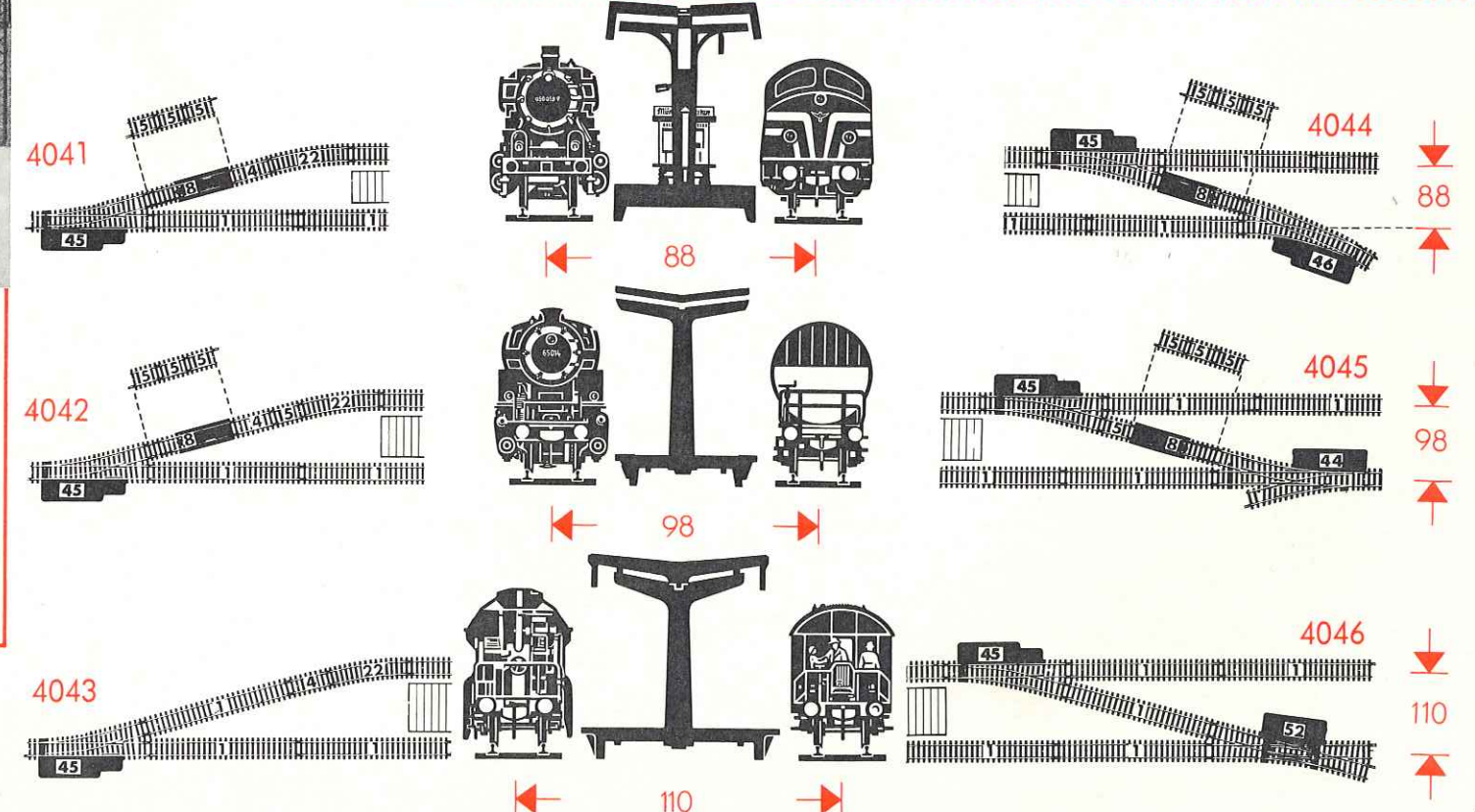

# Gleis-Entwicklungen

spoorbündel  
 faisceau de voies  
 sviluppi dei binari  
 development of tracklines  
 spårutbygging

**M**  
 4050  
 —  
 4078

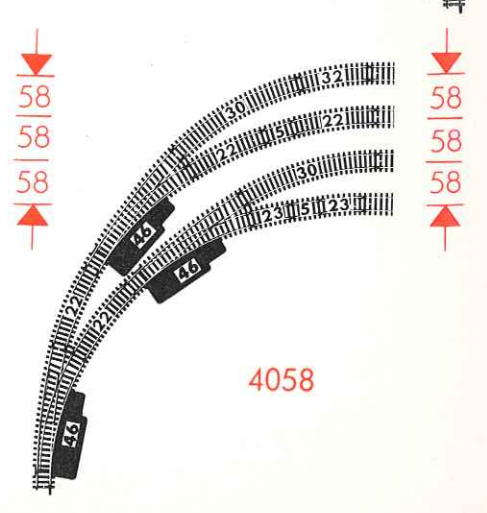
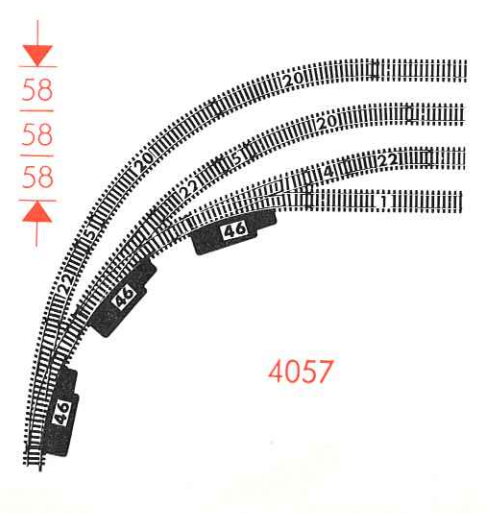
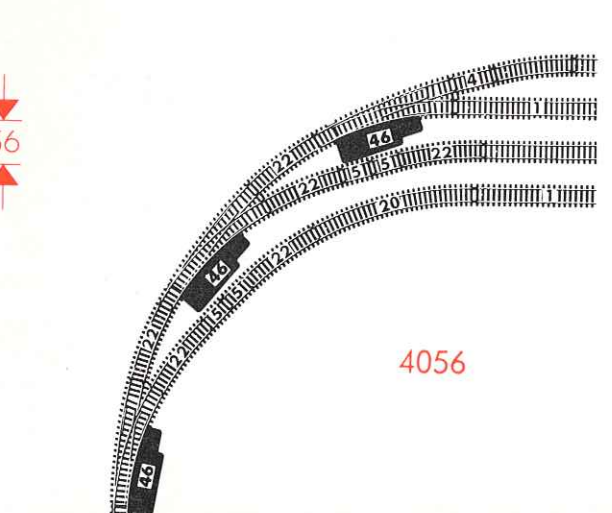
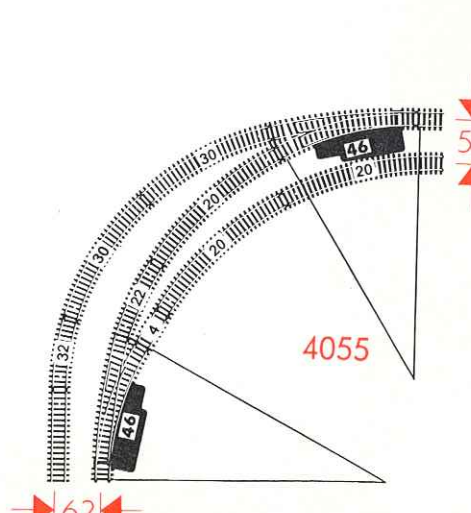
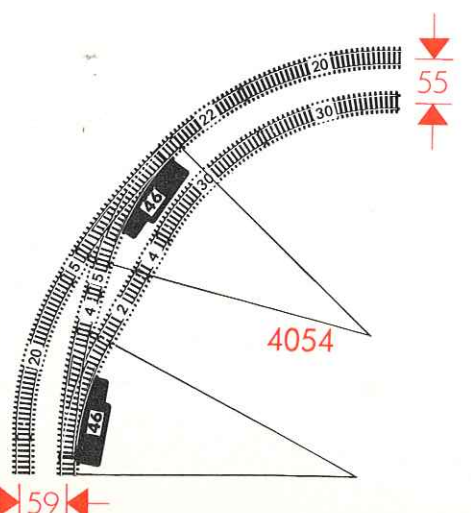
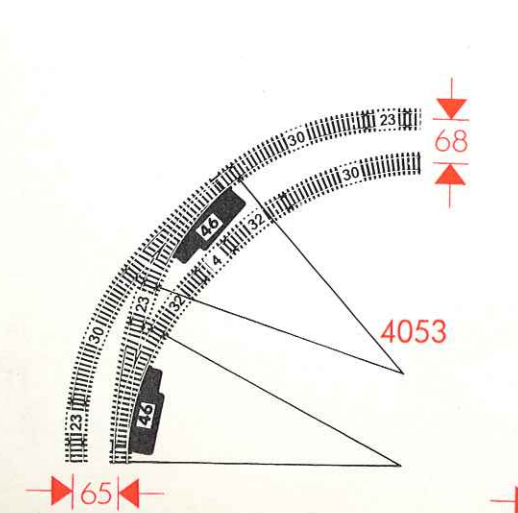
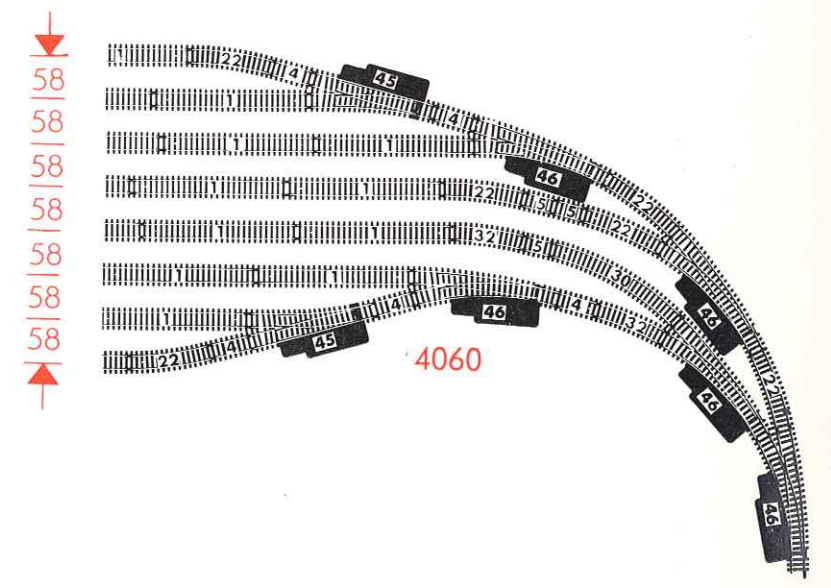
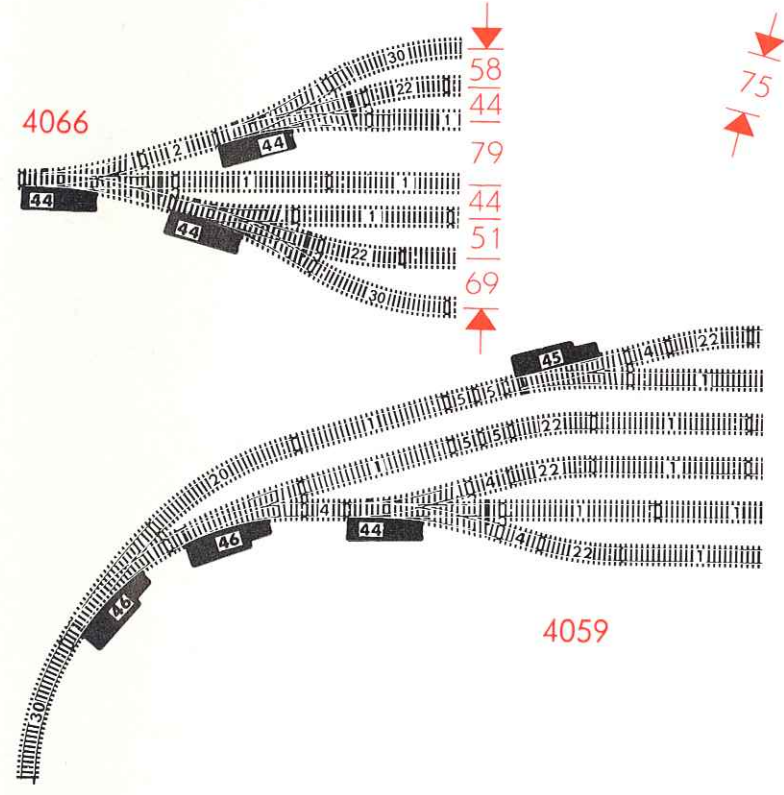
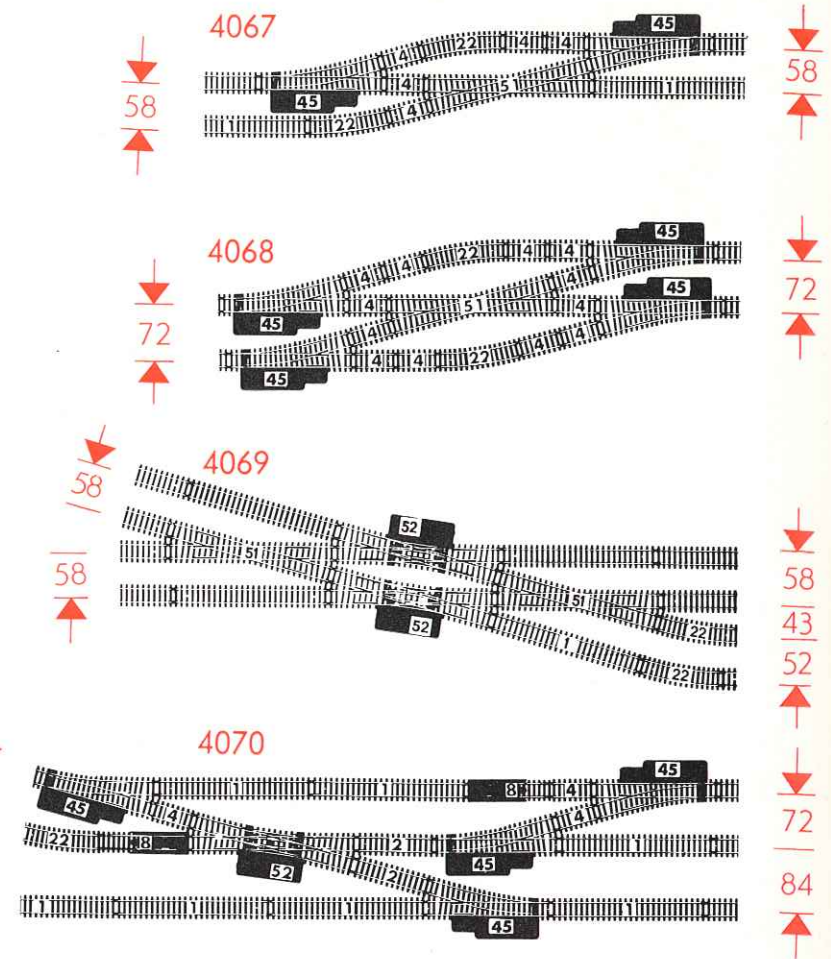
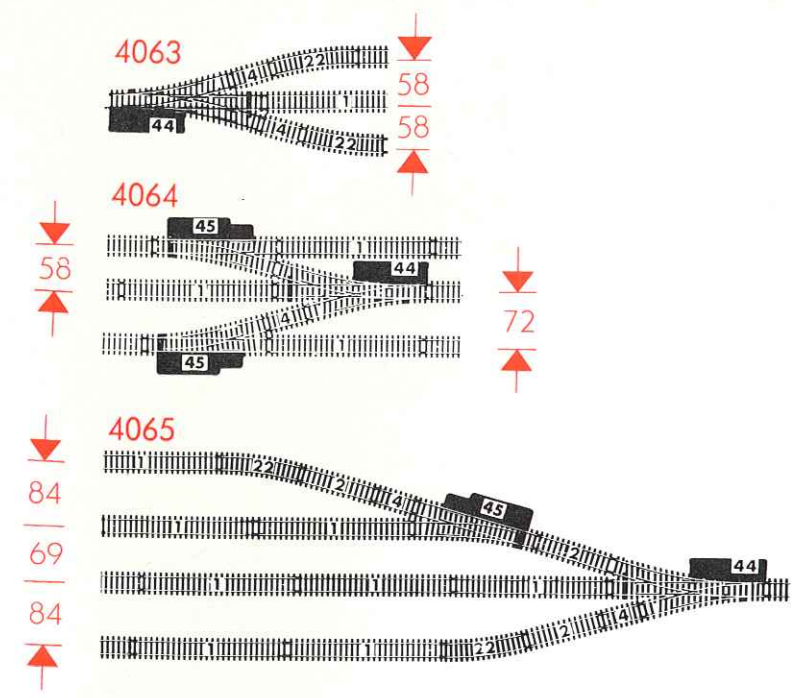
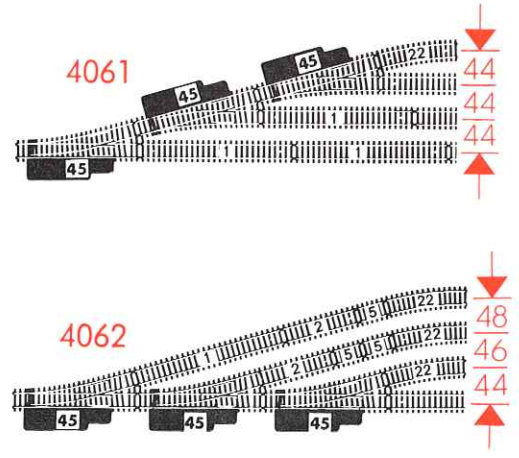
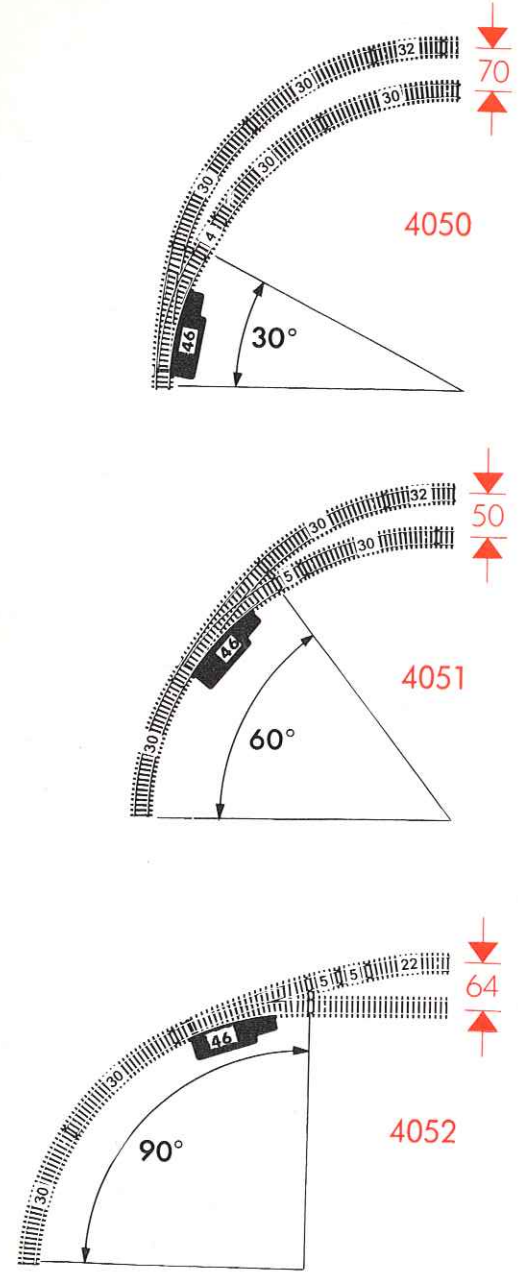



Bahnhöfe · stationen · stations · stazioni · stations · stationer

**M**  
4100  
—  
4105

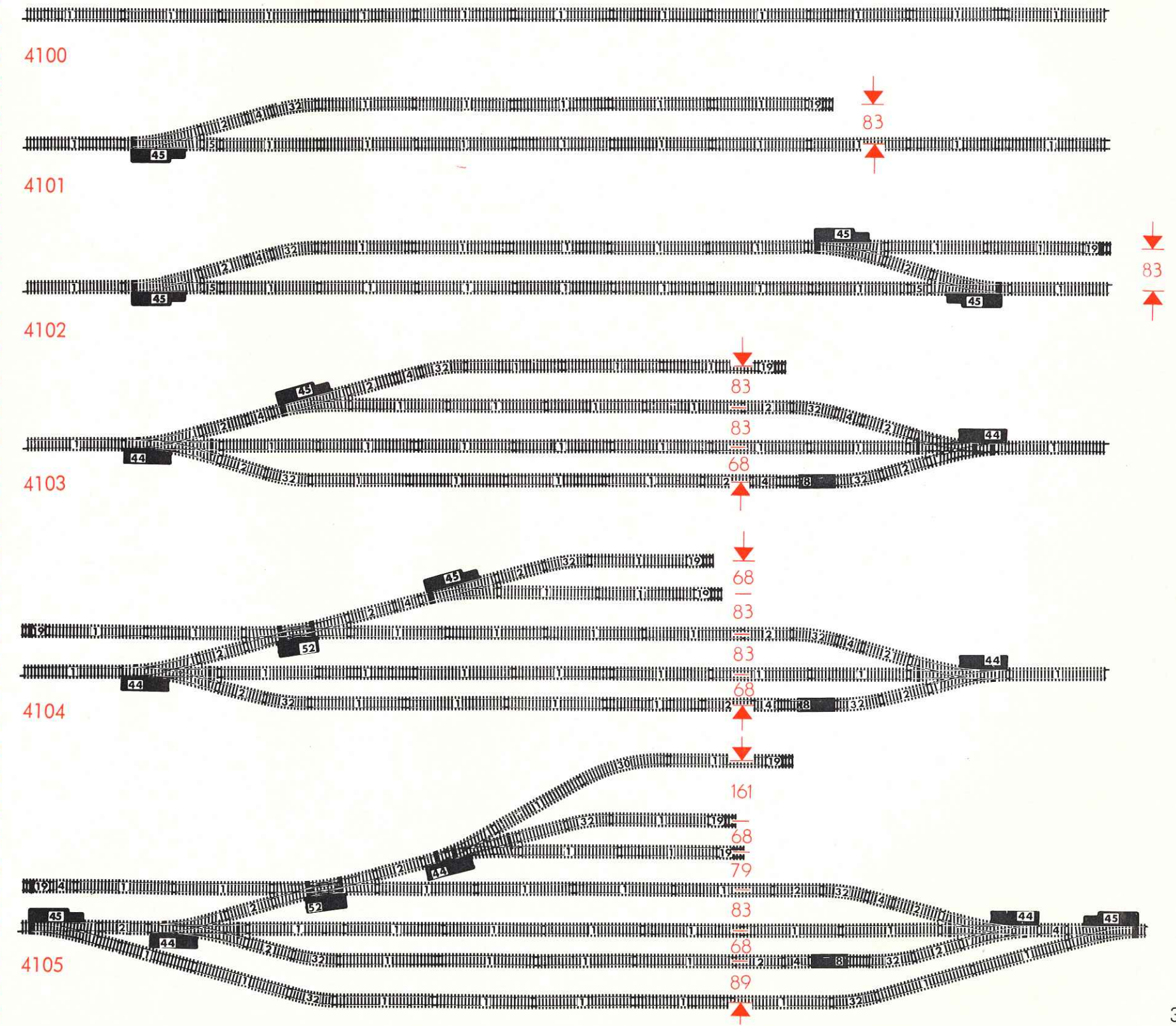
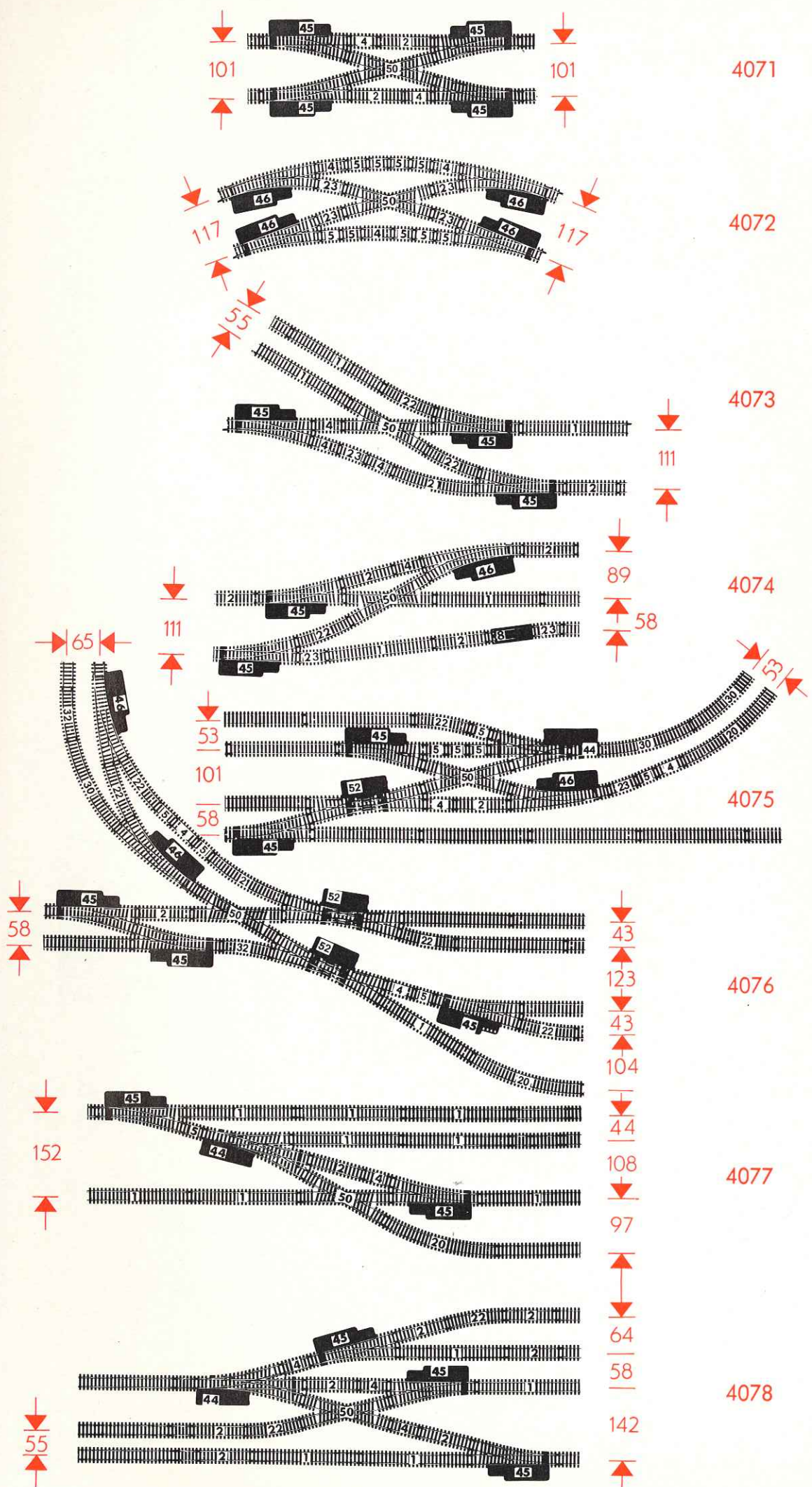
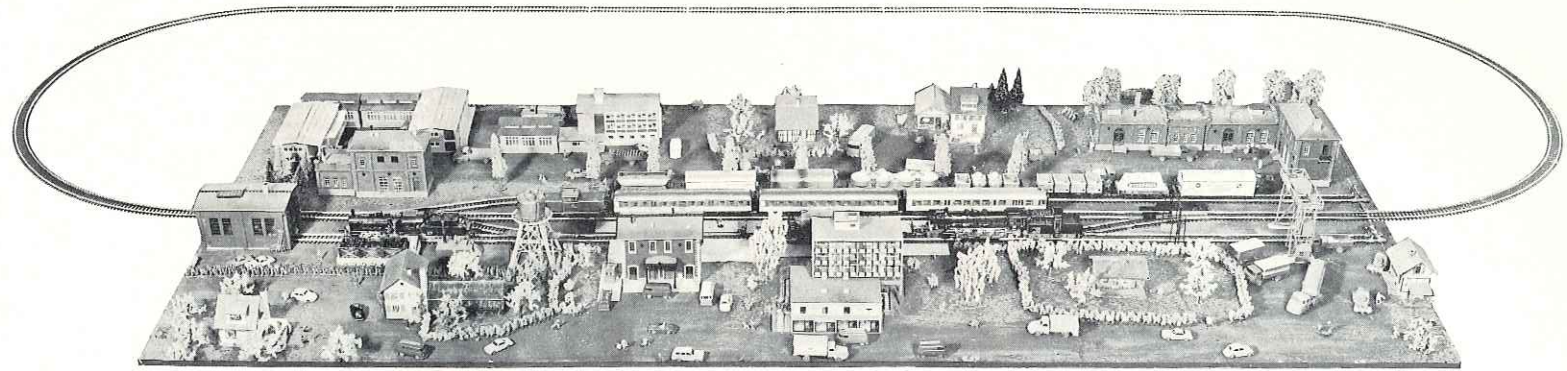

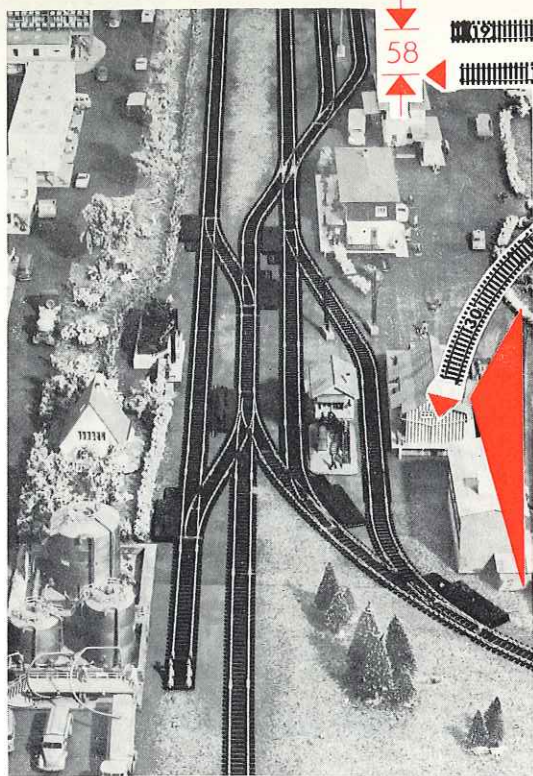

**M**  
4111

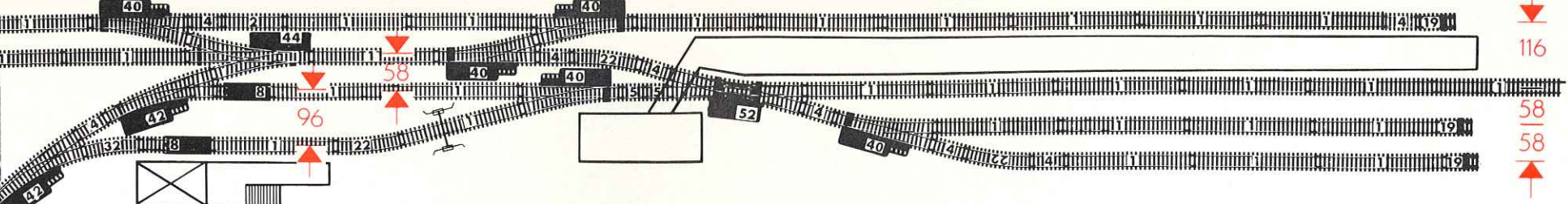

**M**  
4109

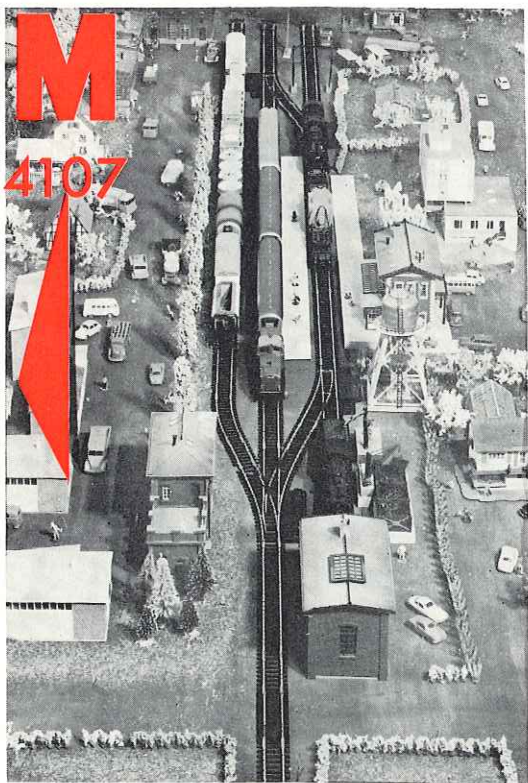
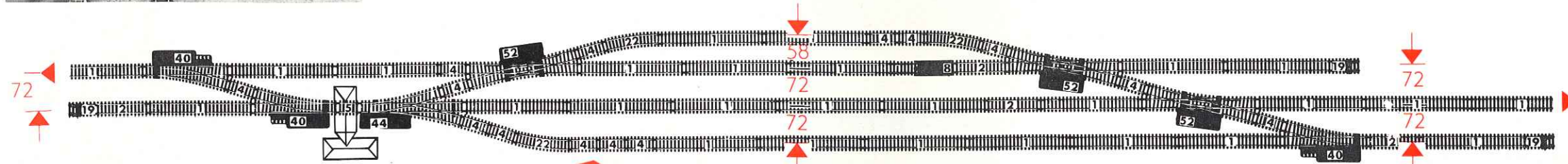
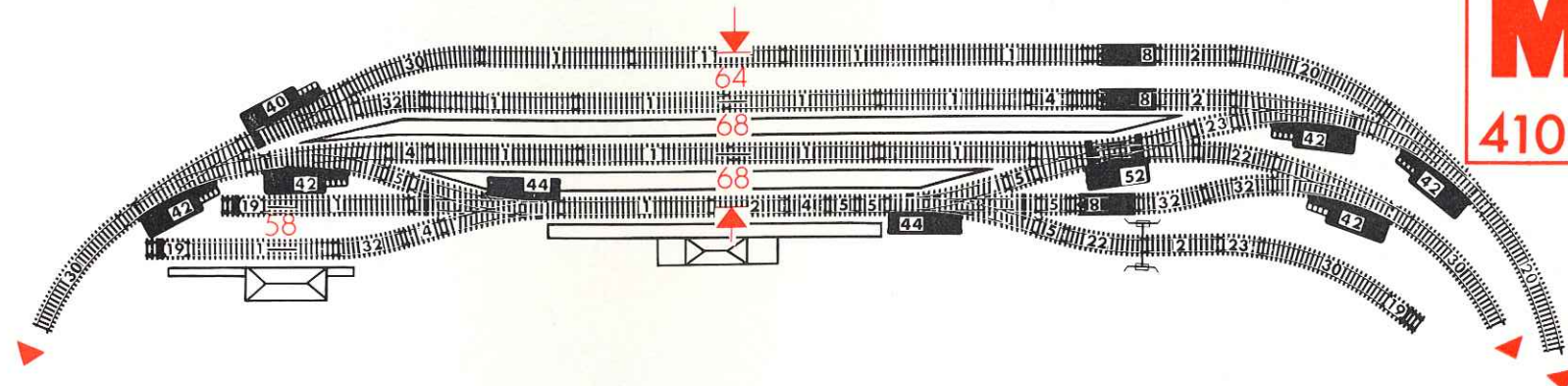

**M**  
4107

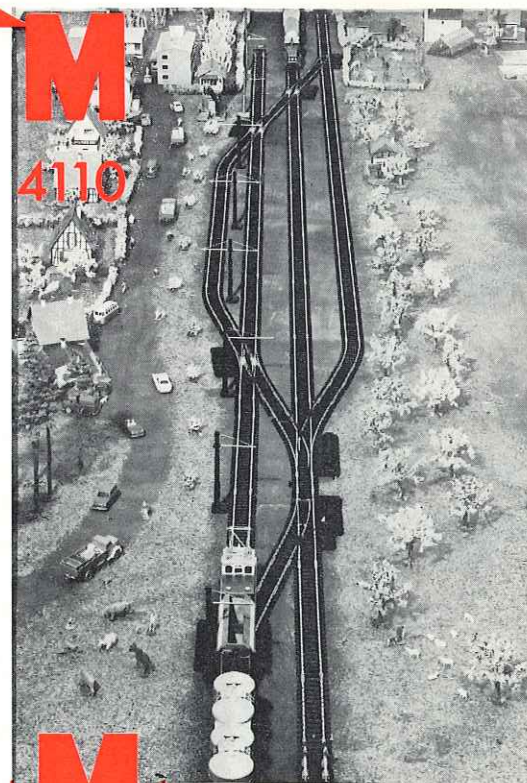

**M**  
4110

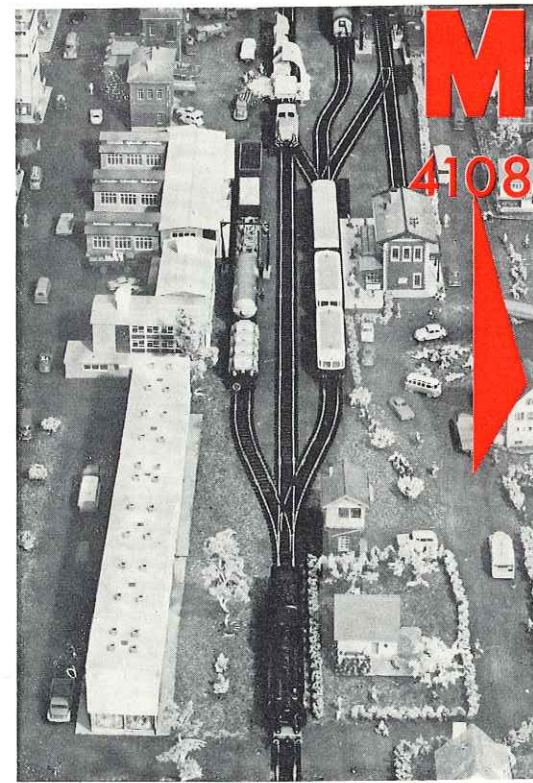

**M**  
4108

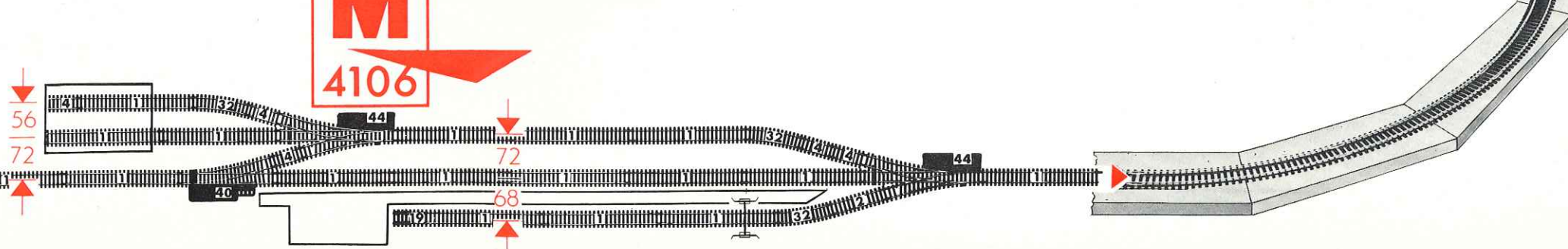

**M**  
4106

# «System 530»

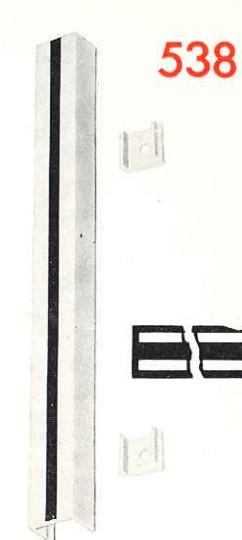
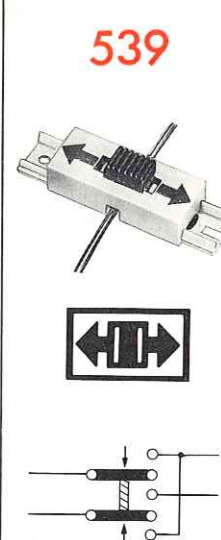
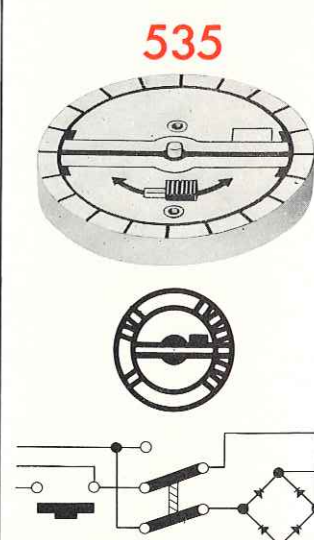
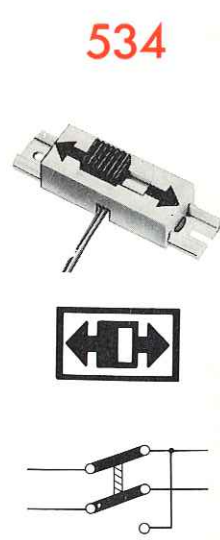
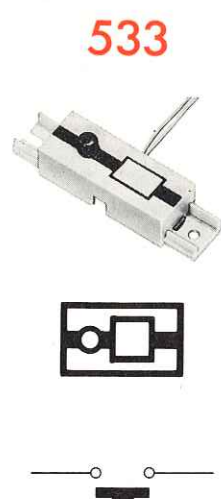
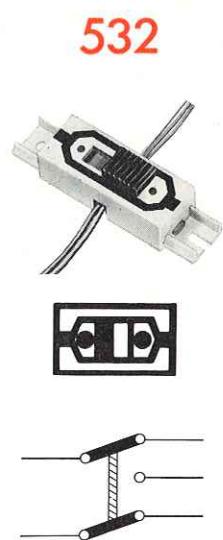
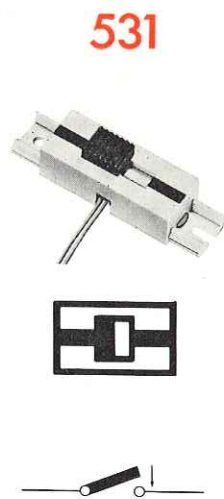
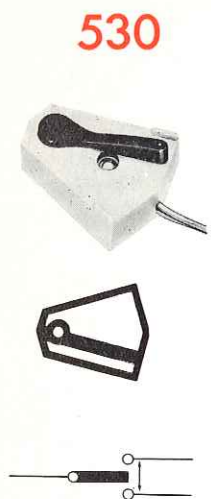

**Schaltgeräte**  
 schakelartikelen  
 postes de commande  
 interruttori  
 remote control switches  
 ställpultar

# «System 500»

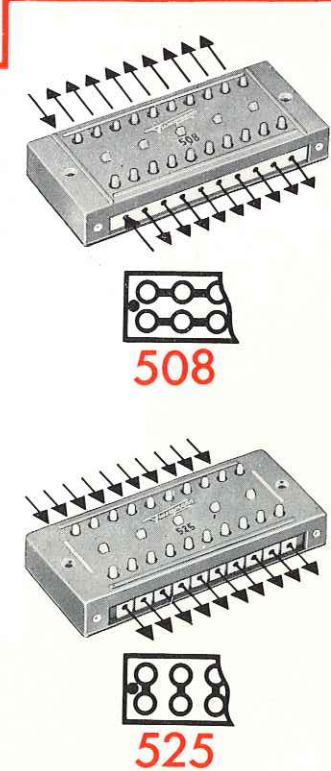
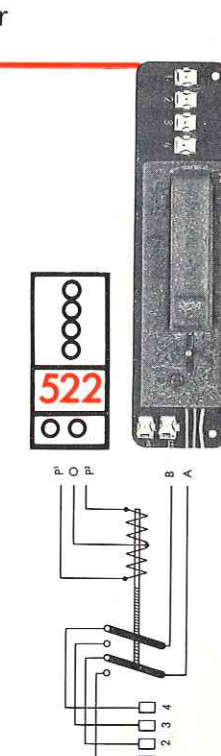
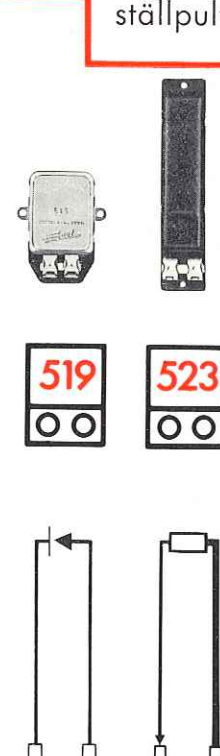
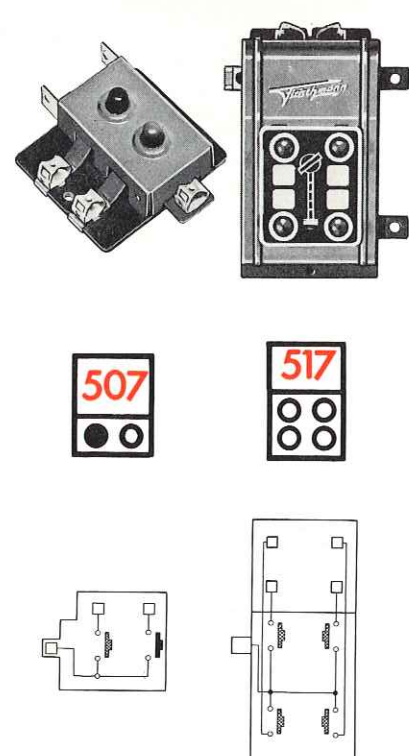
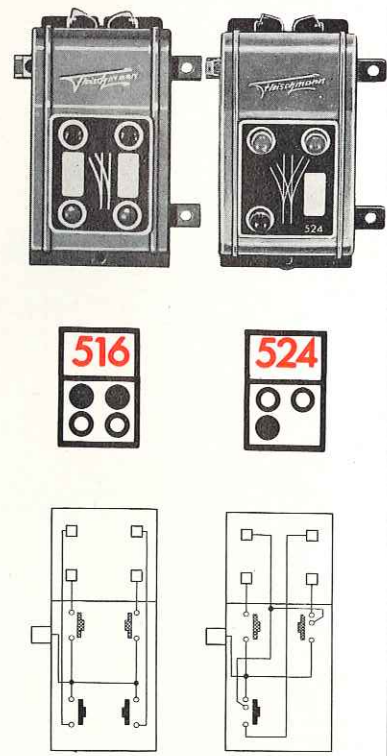

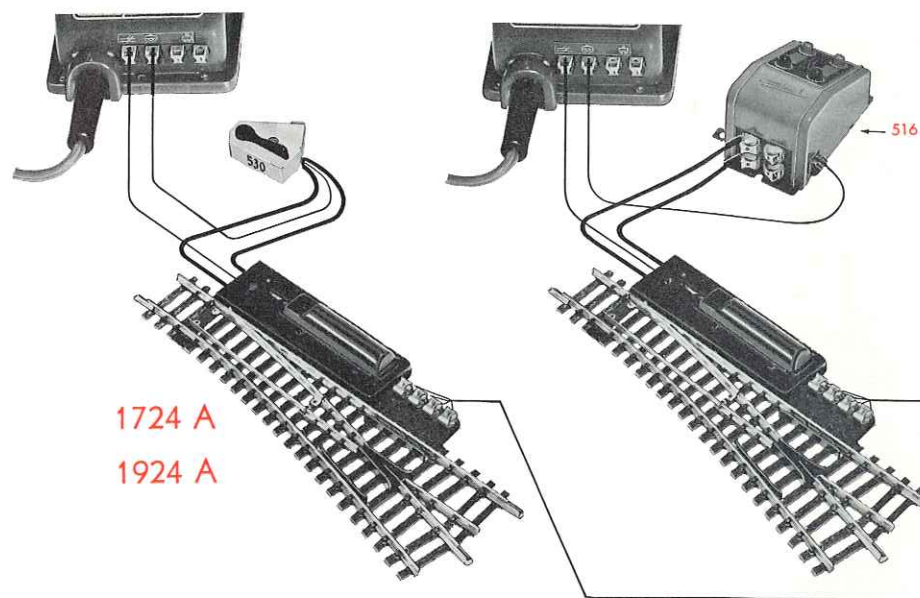
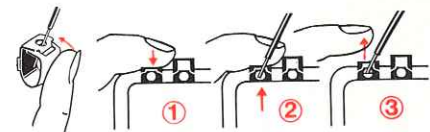
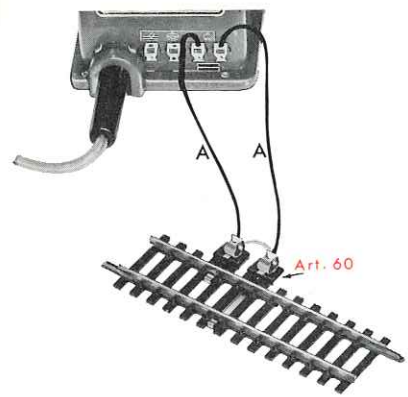

zusätzl.  
Anschlußmöglichkeiten  
ulteriori possibilità  
di collegamento  
anslutningsmöjligheter  
extra aansluit-  
mogelijkheden  
other hook-up  
possibilities  
autres possibilités  
de raccordement

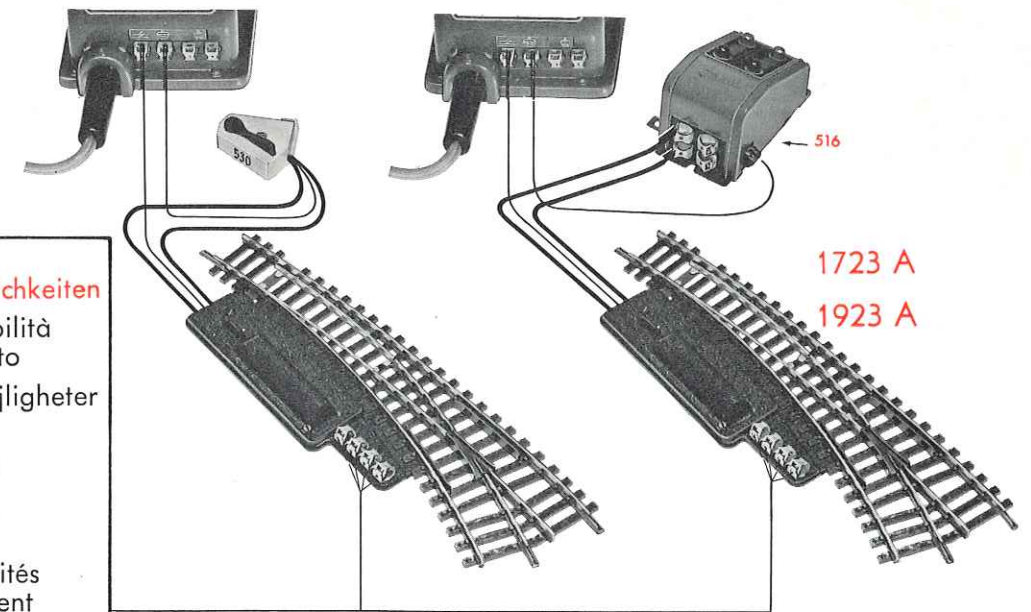

elektrische Anschlüsse · elektrische aansluitingen · câblages · attaccamenti elettrici · electric connections · elektriska ledningar

- A **gelb** yellow jaune giallo gul geel
- B **blau** blue bleu blu blå blauw
- C **schwarz** black noir nero svart zwart
- D **weiss** white blanc bianco wit wit
- E **hellbraun** light brown brun clair marrone chiaro ljustbrun lichtbruin
- F **dkl.braun** dark brown brun foncé marrone scuro mörkbrun donkerbruin
- G **grün** green vert verde grön groen
- H **rot** red rouge rosso röd rood
- J **grau** grey gris grigio grå grijs

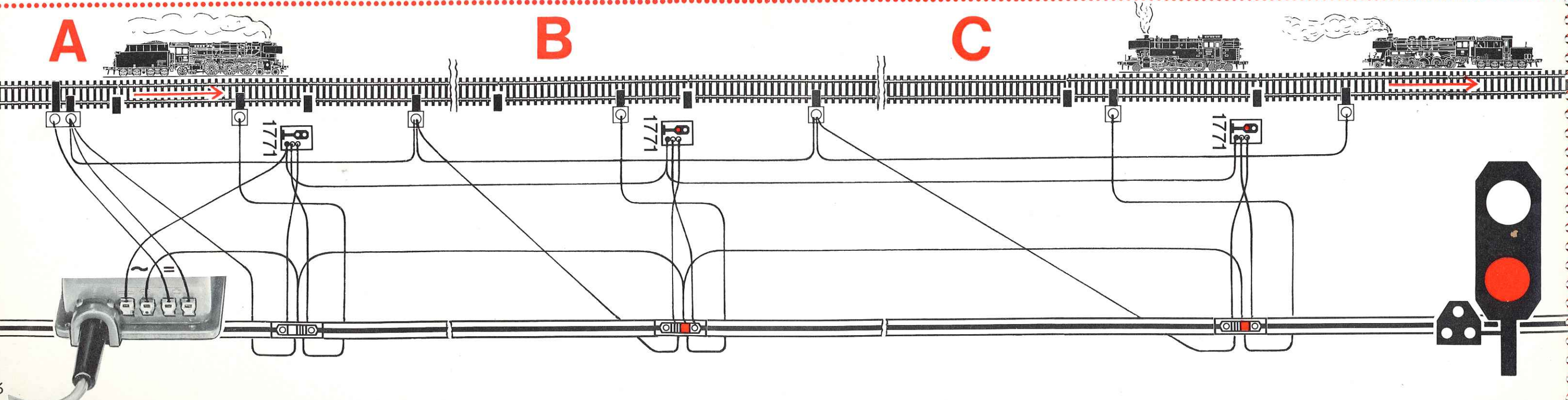
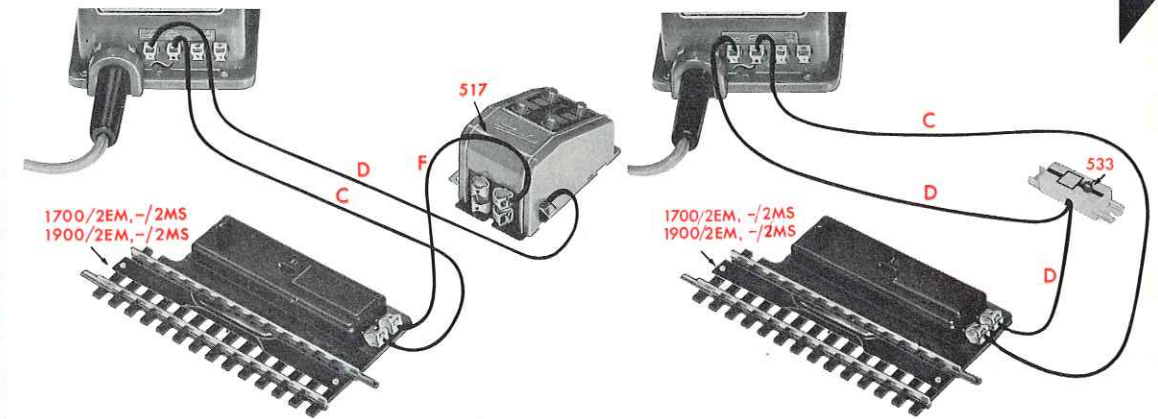
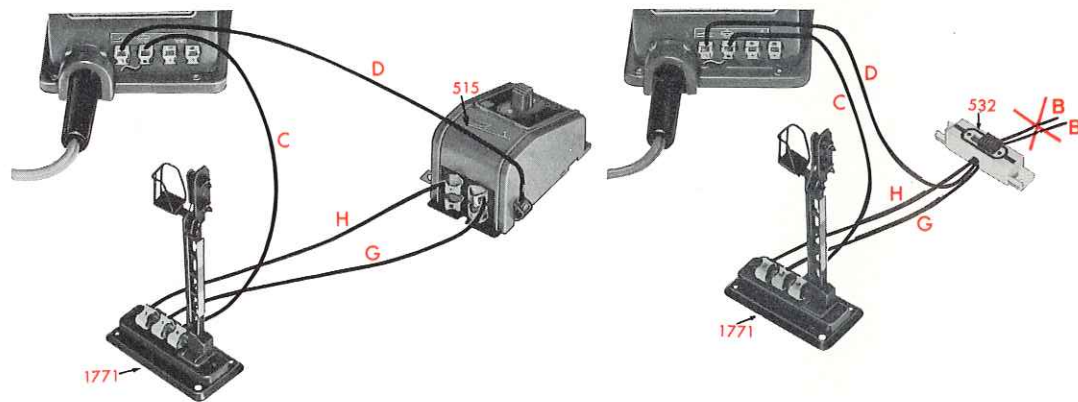

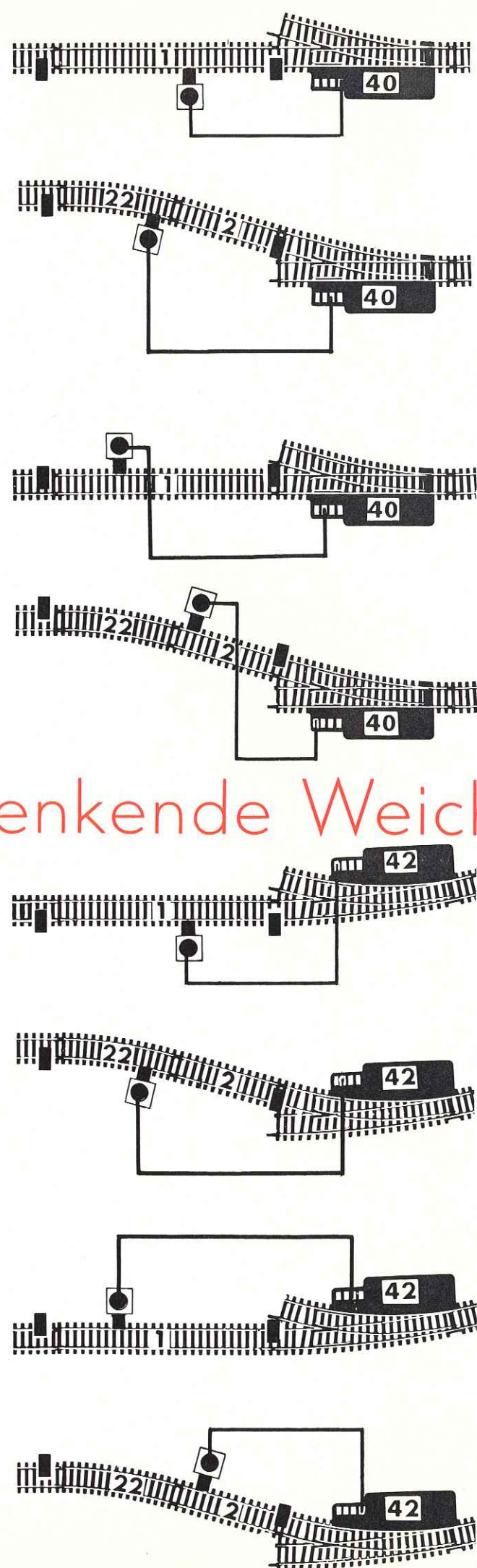
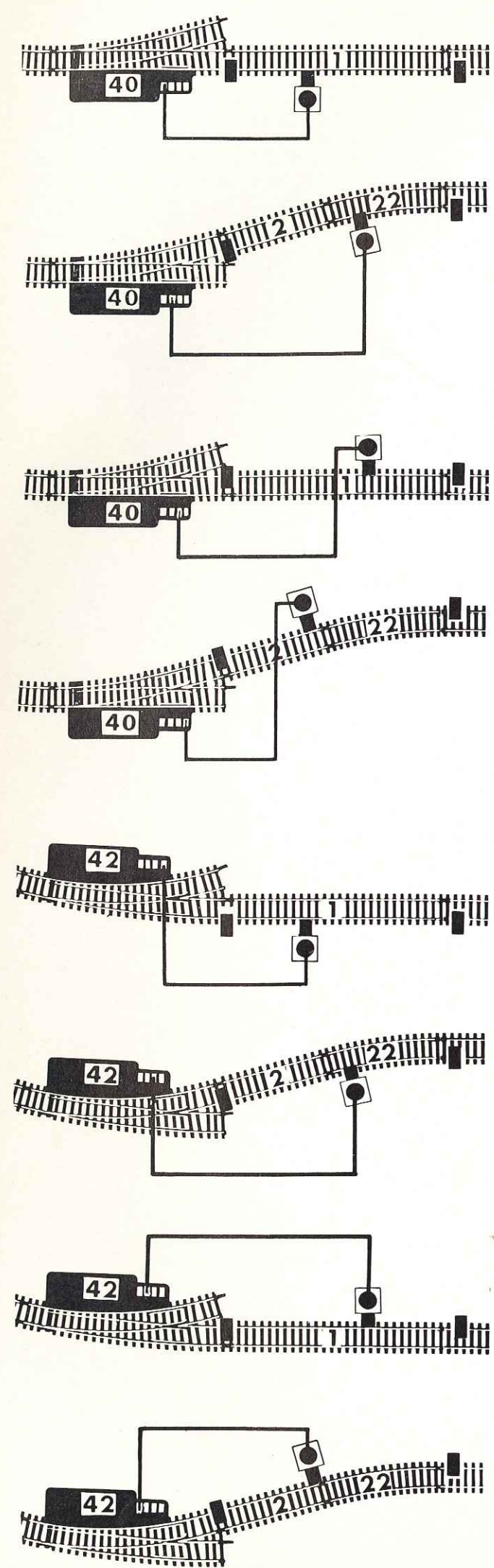

# «Denkende Weichen»

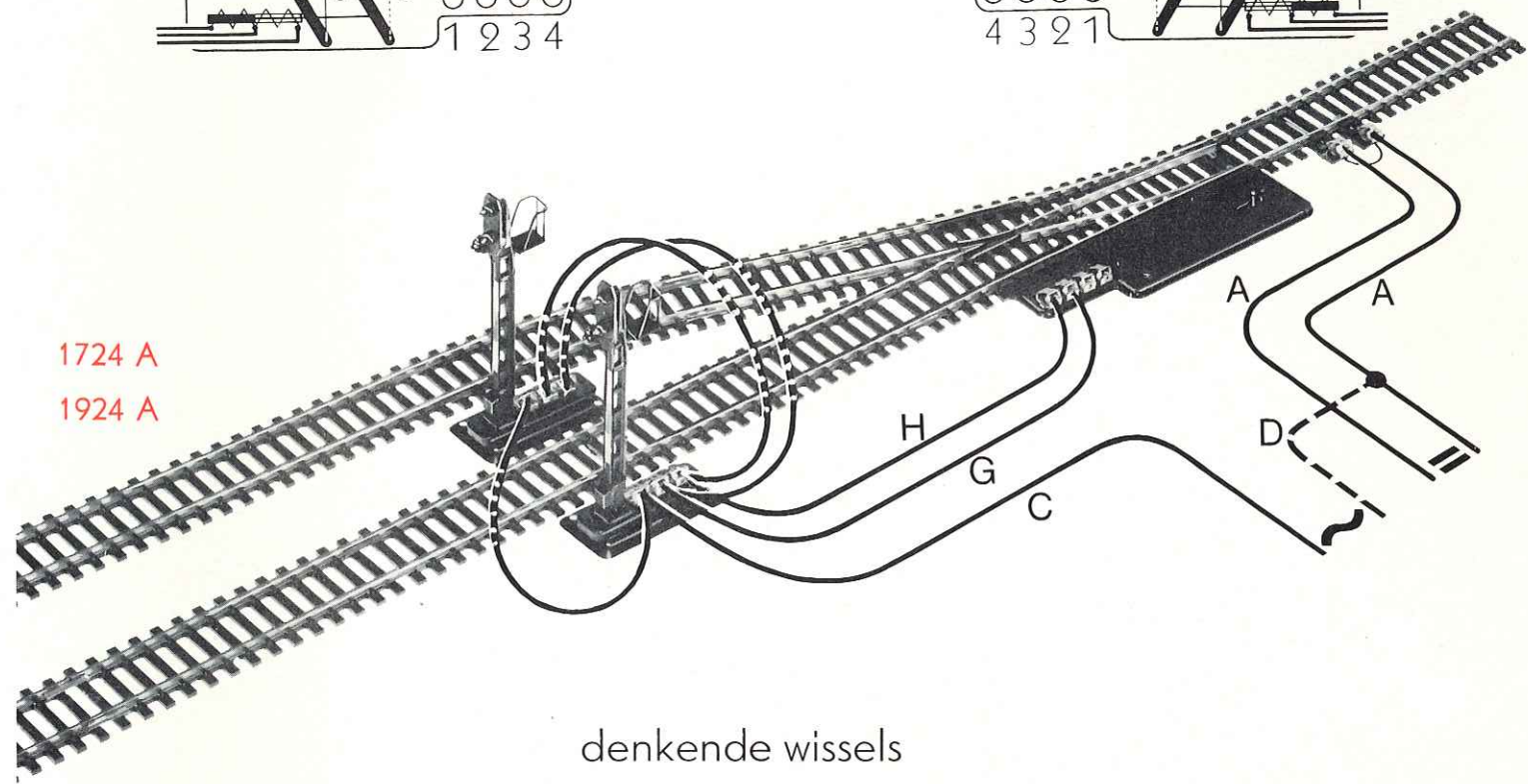
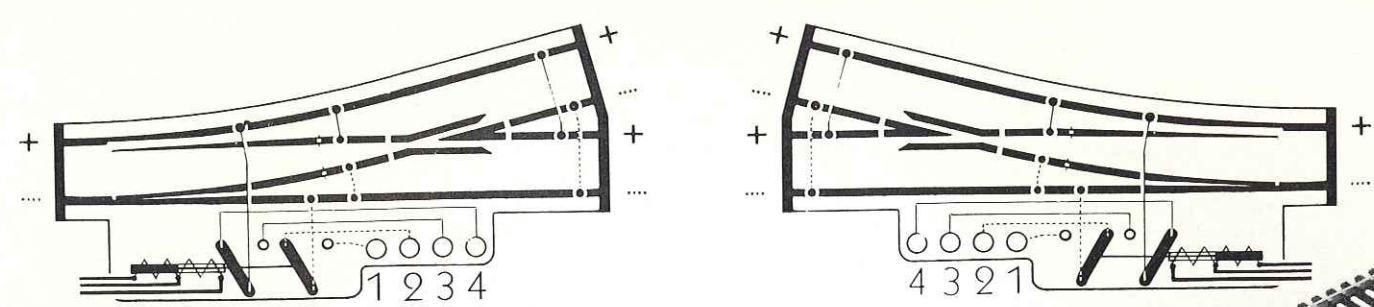

1724 A  
1924 A

denkende wissels  
des aiguillages qui «réfléchissent»  
prestigiosi scambi  
switches that think for you  
tänkande växlar

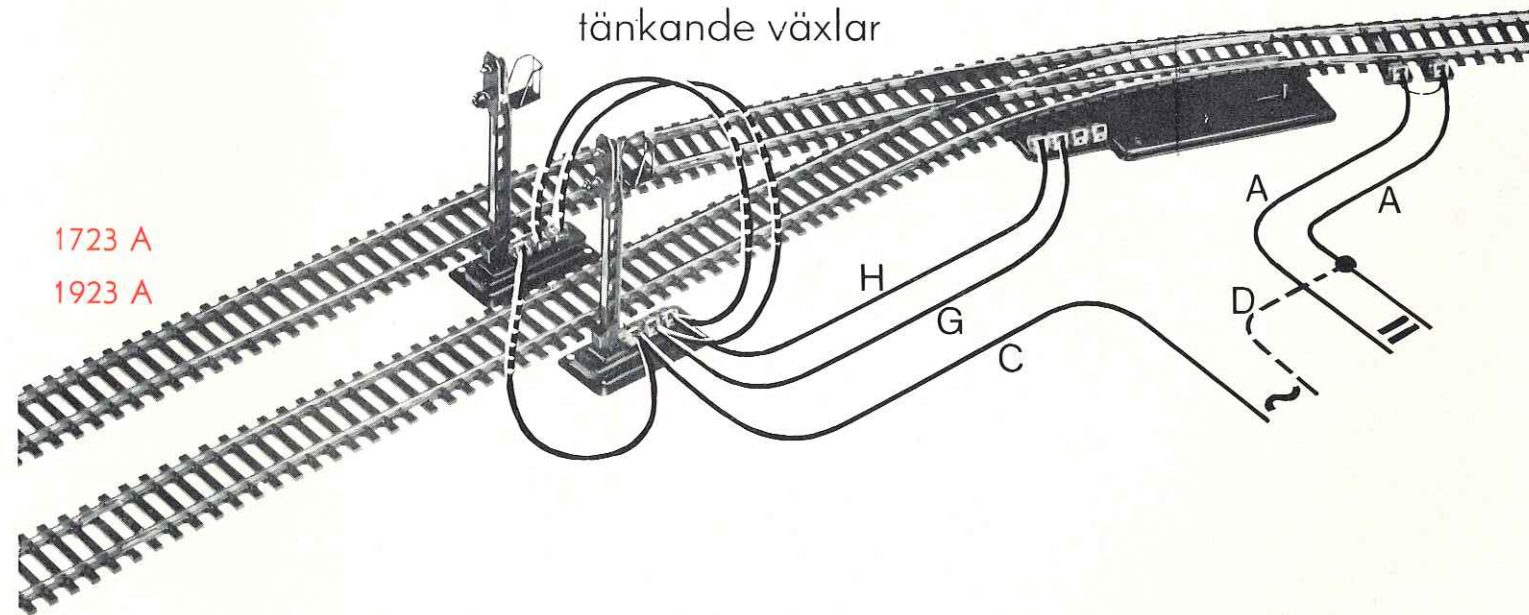

1723 A  
1923 A

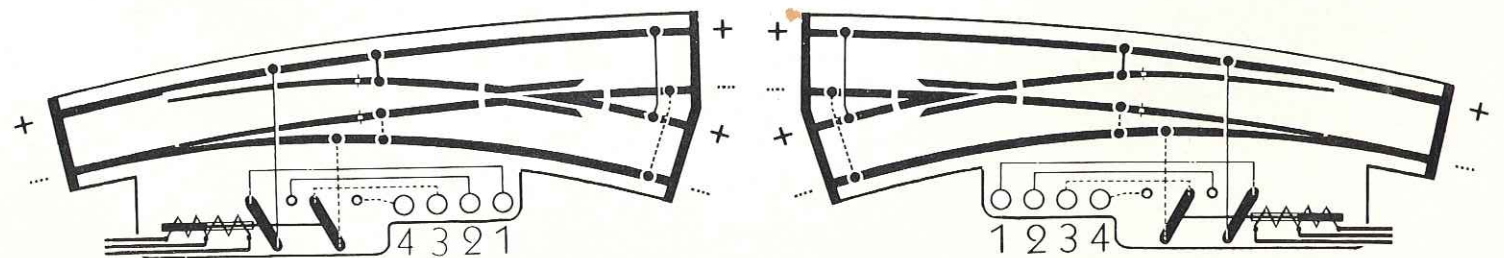

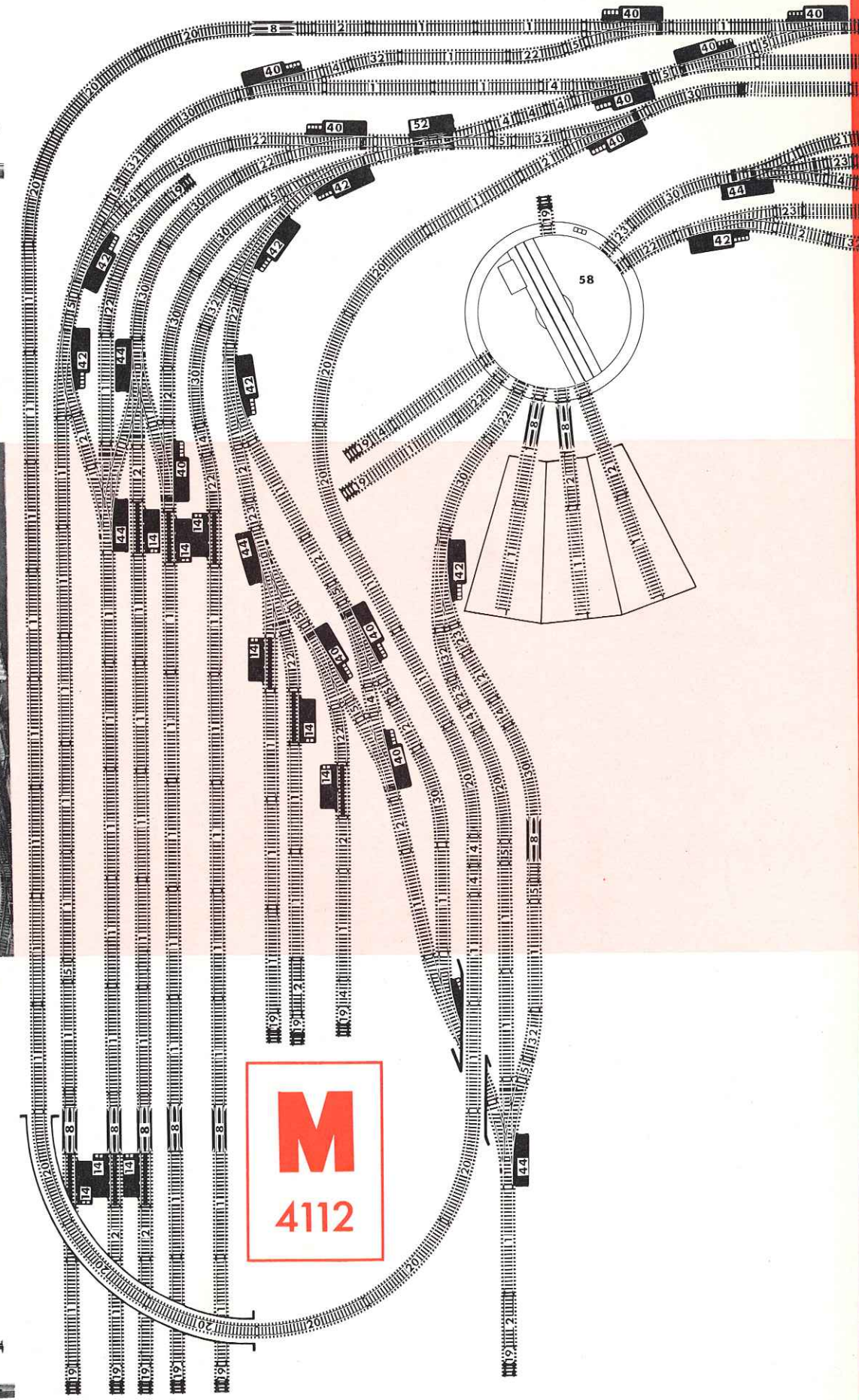
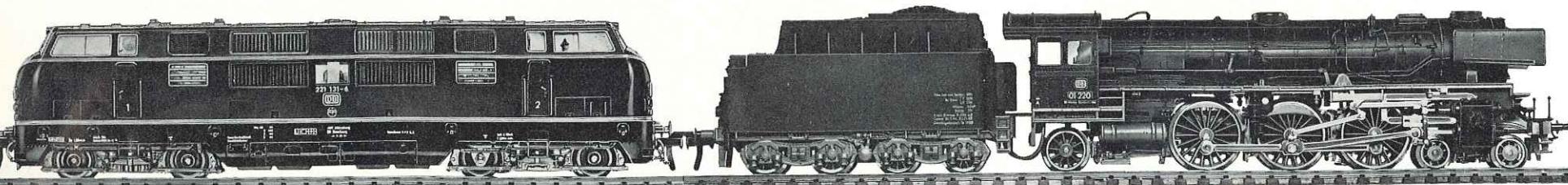
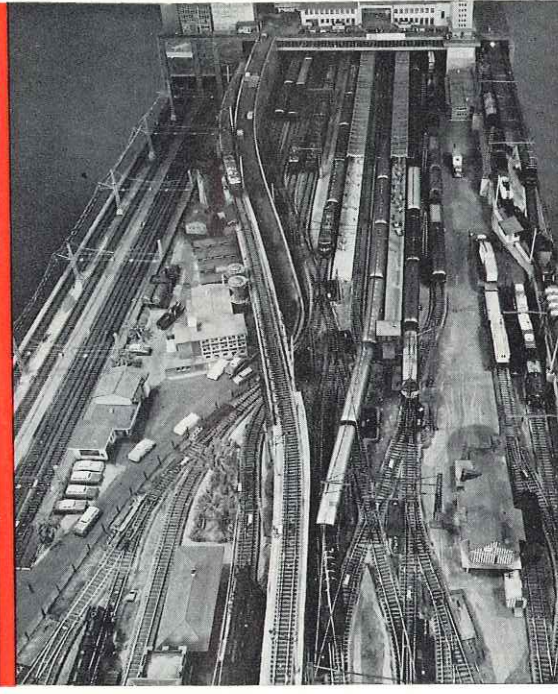
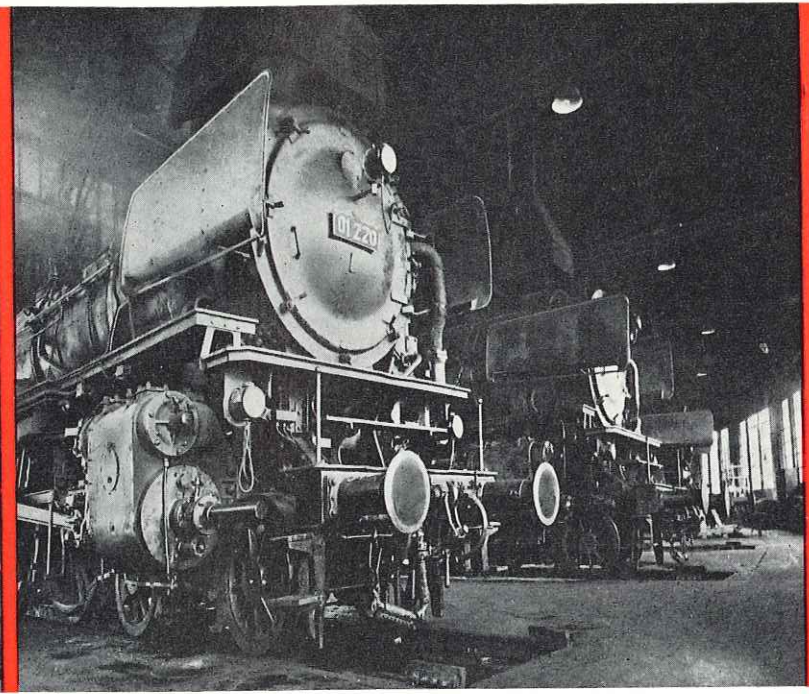
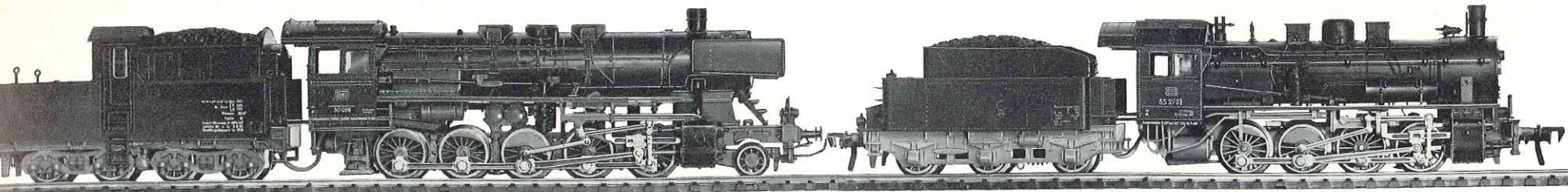

Anlagen-Pläne — einfach, mittelgroß, groß — flach  
in verschiedenen Ebenen — mit Verdrahtung

Baanontwerpen eenvoudig, middelgroot, groot, vlak.  
in verschillende etages met bedrading

Plans de réseaux simples,  
moyens, grands, étendus.  
à différents niveaux avec câblage

Schemi di impianti semplici,  
di media grandezza, grandi, in piano,  
a diverse altitudini con  
collegamento elettrico

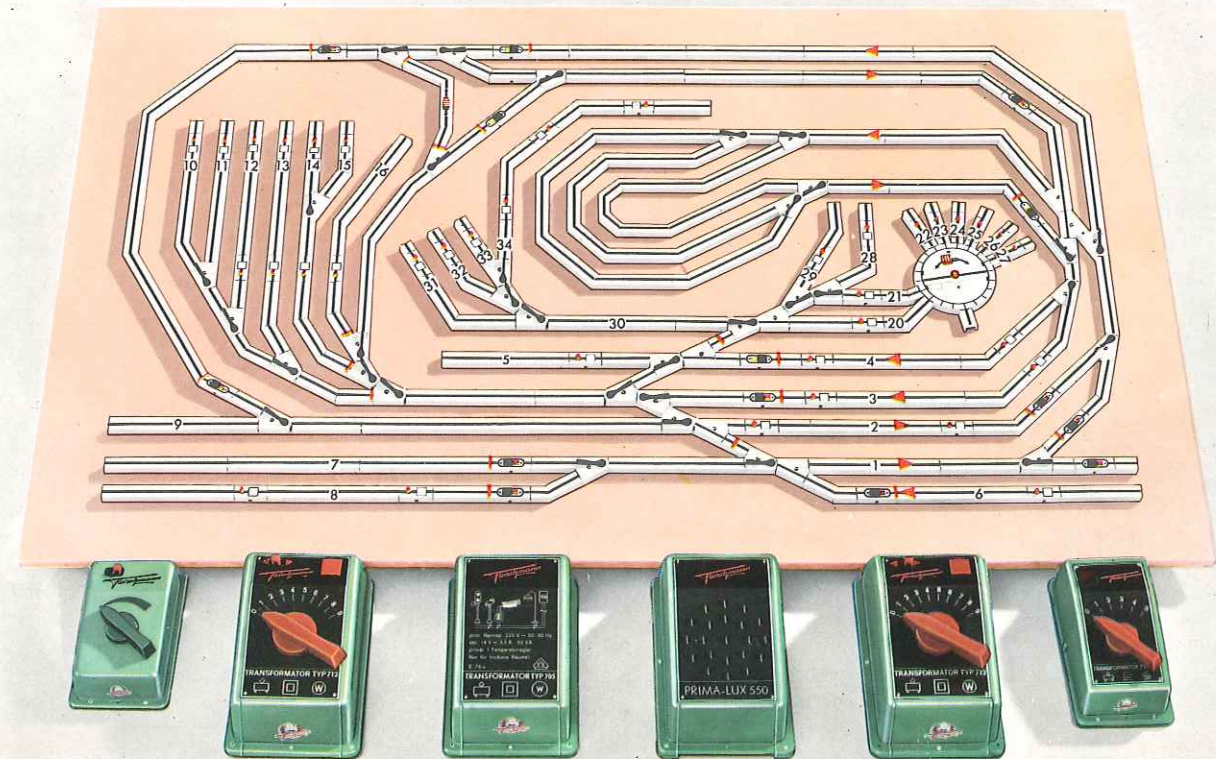
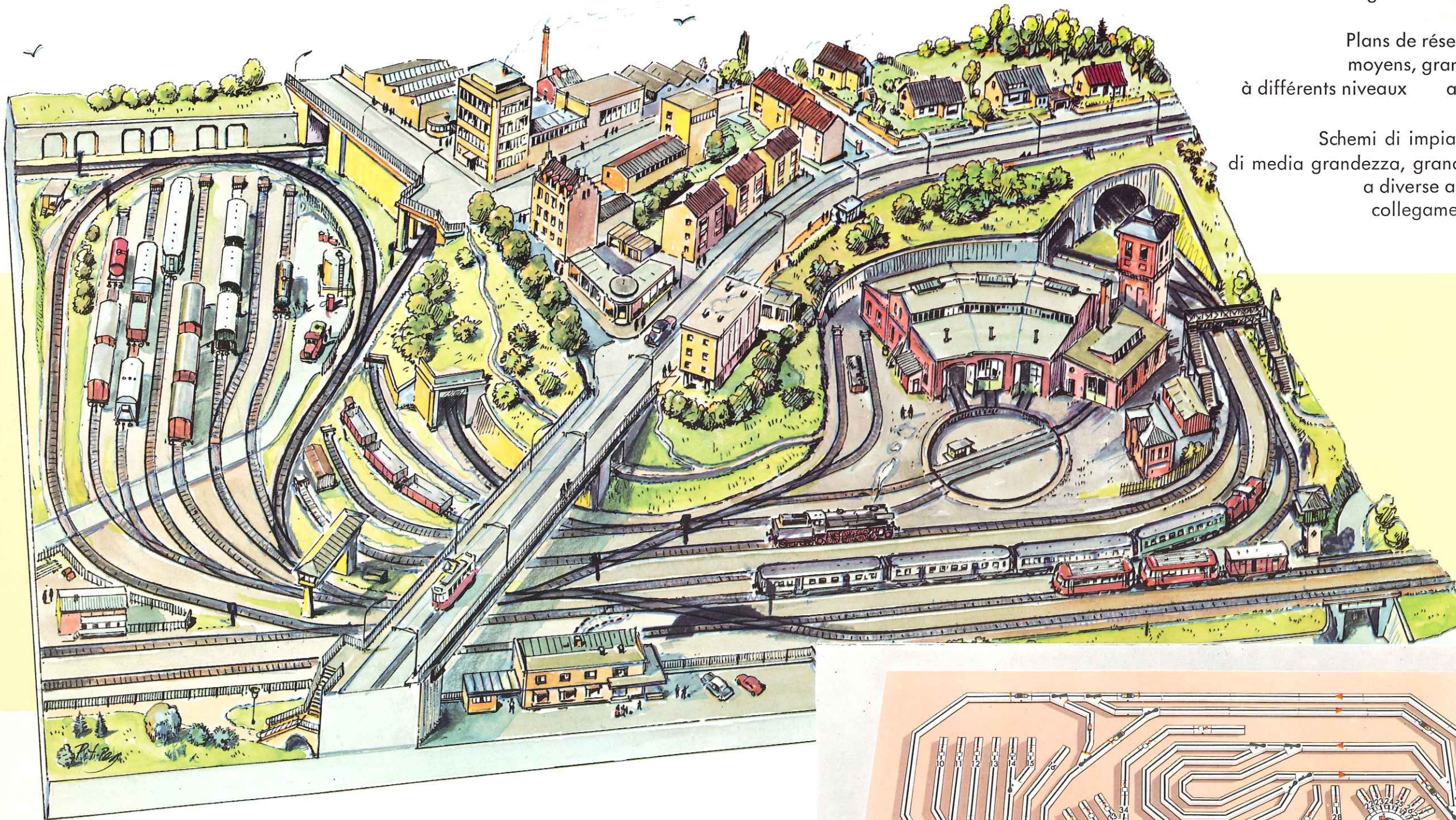

Planos de maquetas sencillas, medianas, grandes, a un solo nivel, a varios niveles con conexiones  
layout plans simple, medium-size, large, single-level on several levels with wiring

Ratakaavioita, yksinkertaisia, keskisuuria, suuria, matalia eri tasoissa johdotettuna johdotettuna

Anläggningar enkla, medelstora, stora, plana i olika plan med kopplingar

Anlægs-planer, let, mellemstor, stor, flad med niveauforskelle med strømskema

I

# FLEISCHMANN

## international

DEUTSCHES MUSEUM · MÜNCHEN



VERKEHRS-MUSEUM · NÜRNBERG

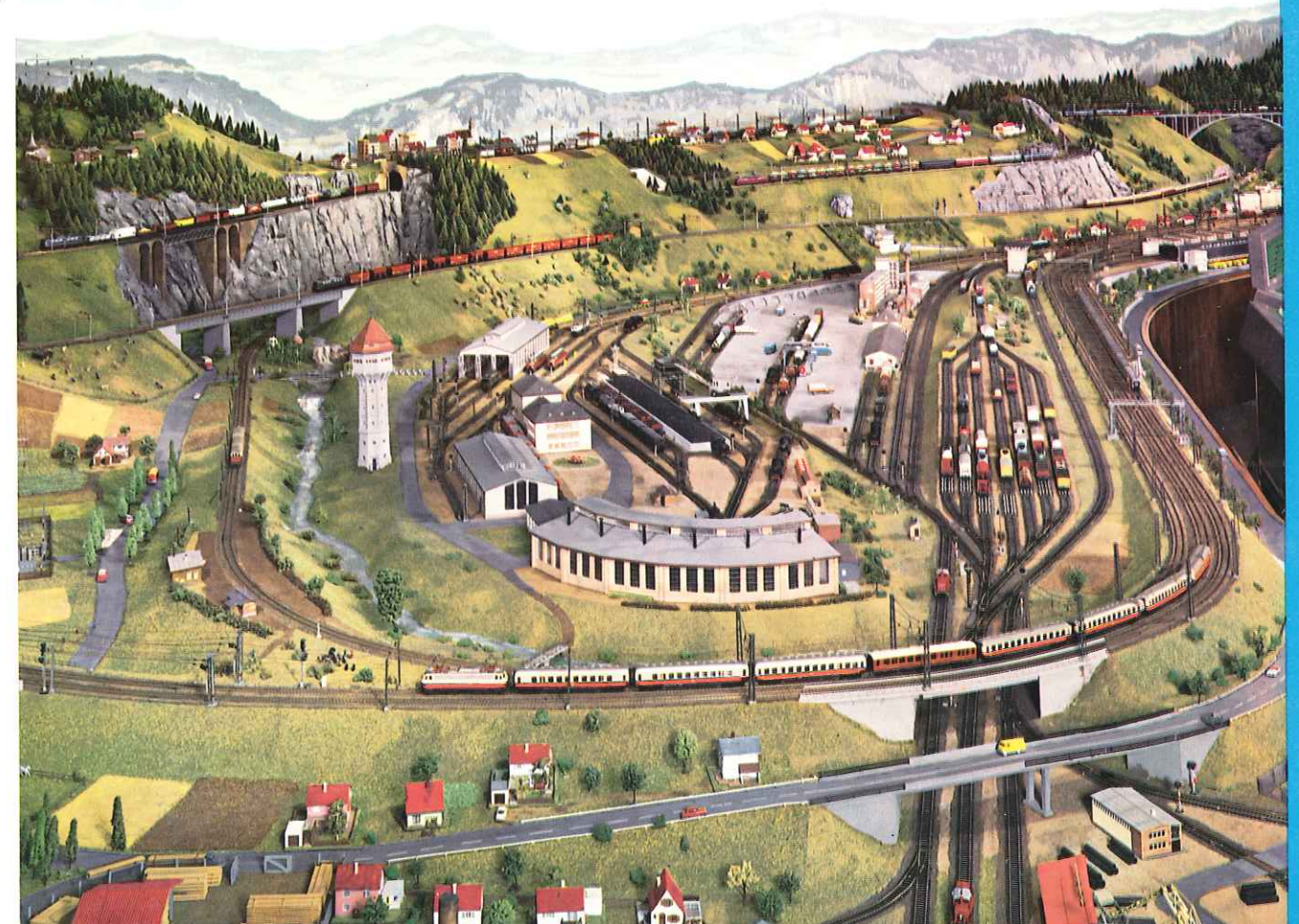
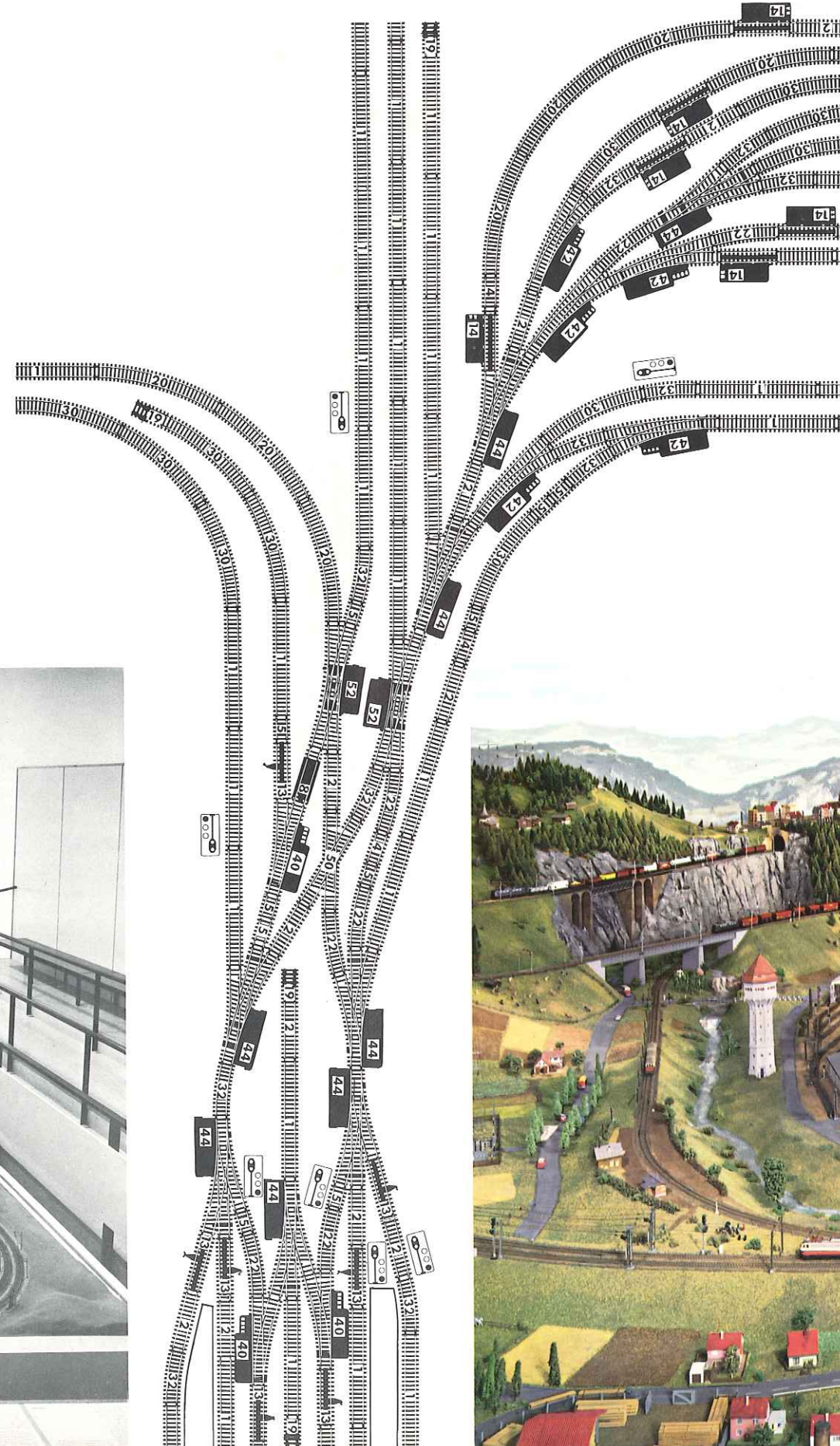
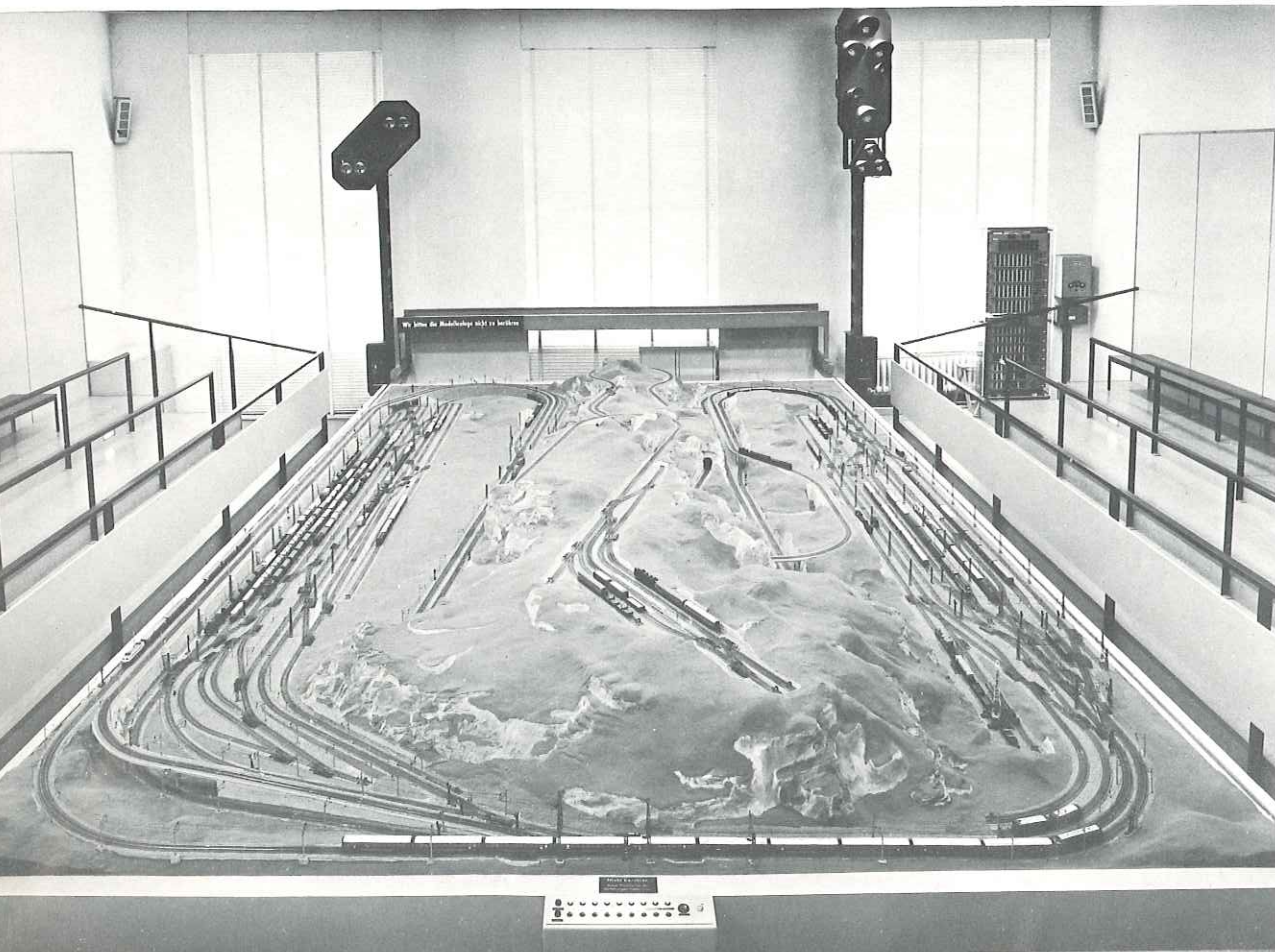





# M

## 4200

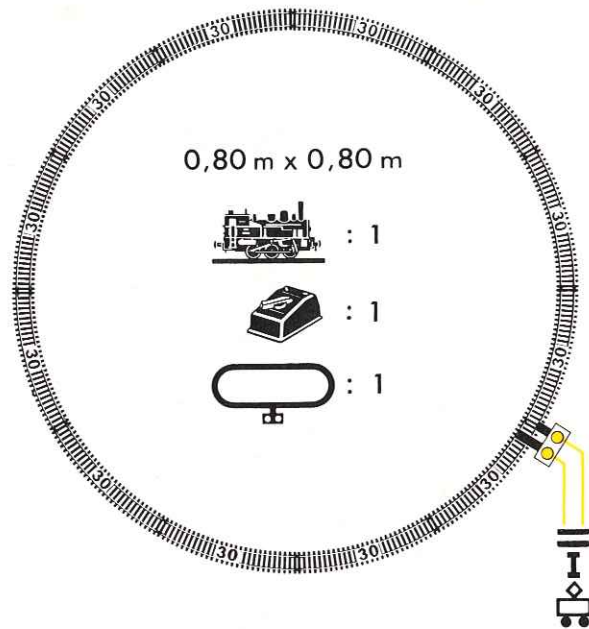

Symb. N°	30		<b>I</b>
Art. N°	· · 03	60	711 712
	12x	1x	1x

# M

## 4201

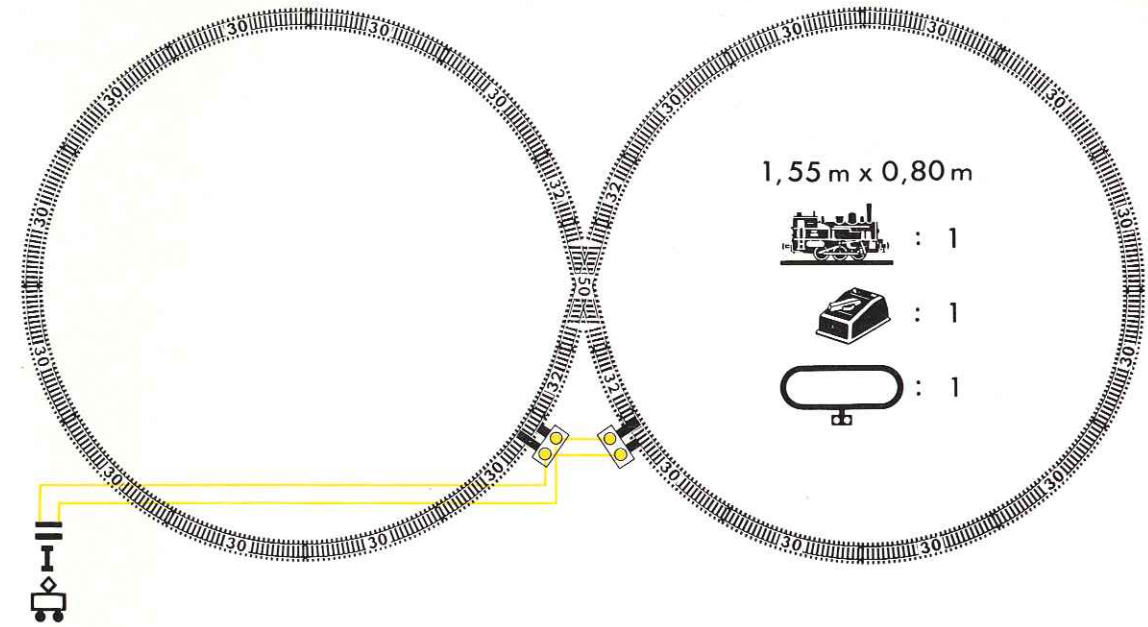

Symb. N°	30	32	50		<b>I</b>
Art. N°	· · 03	· · 03½	· · 12	60	711 712
	20x	4x	1x	2x	1x

# M

## 4202

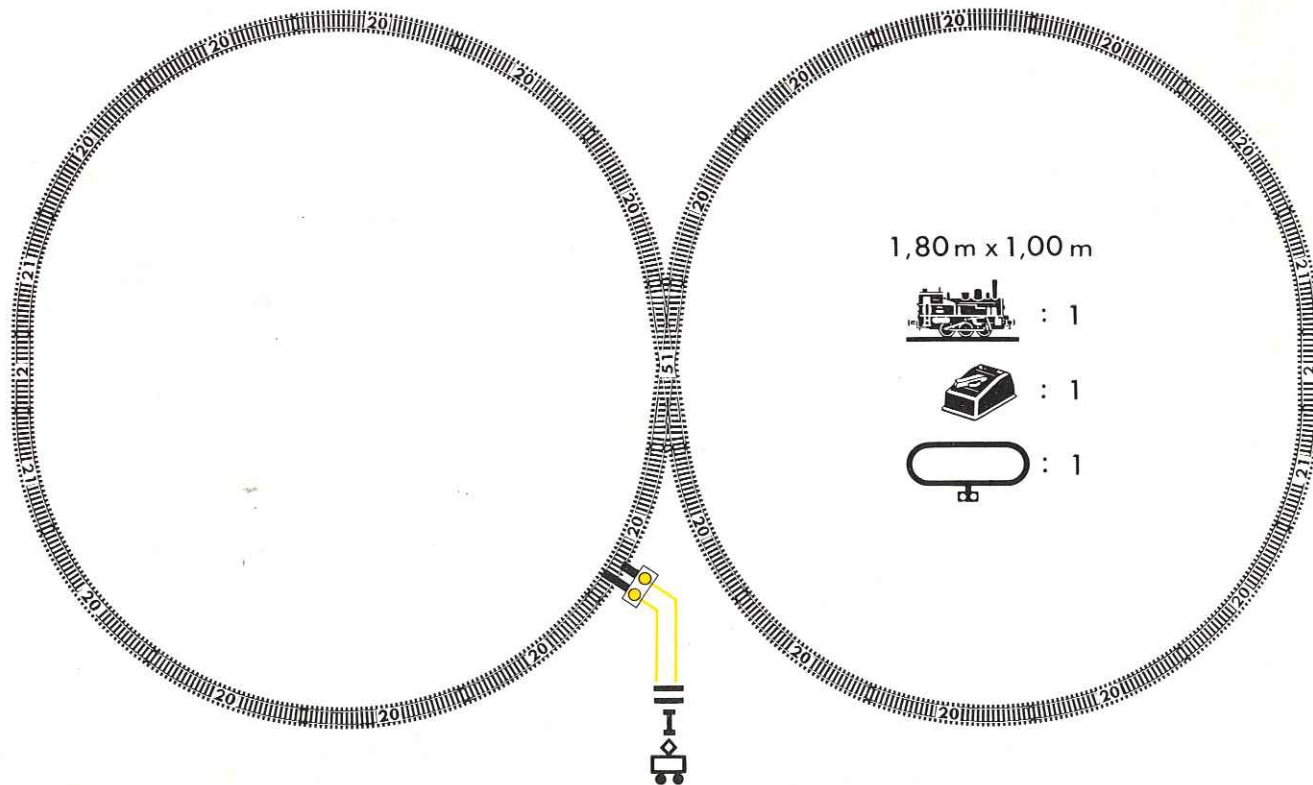

Symb. N°	2	20	21	51		<b>I</b>
Art. N°	· · 00/2	· · 01	· · 01/2	· · 11	60	711 712
	2x	20x	4x	1x	1x	1x

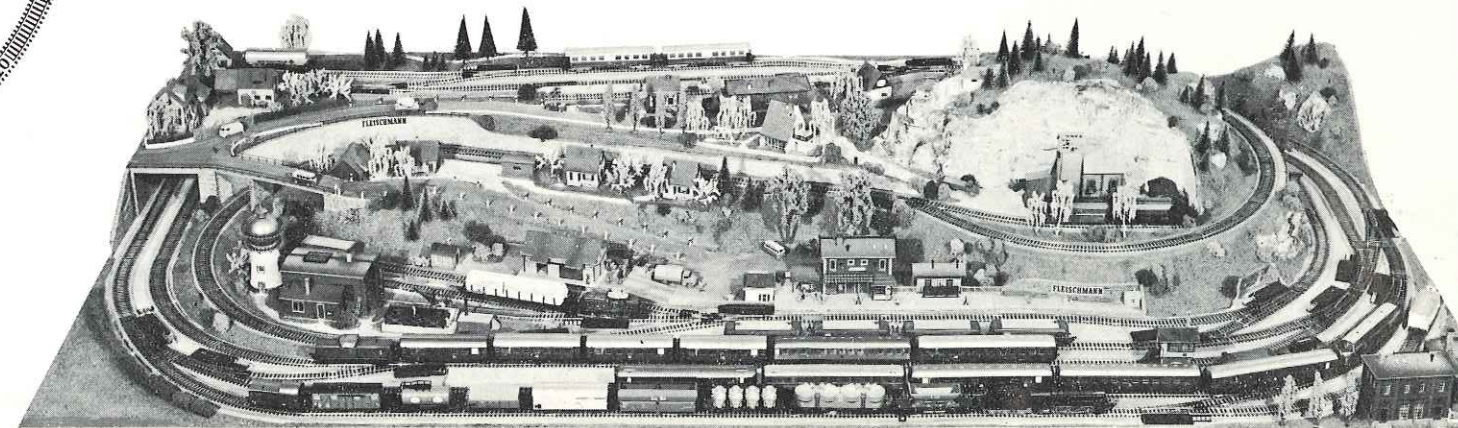

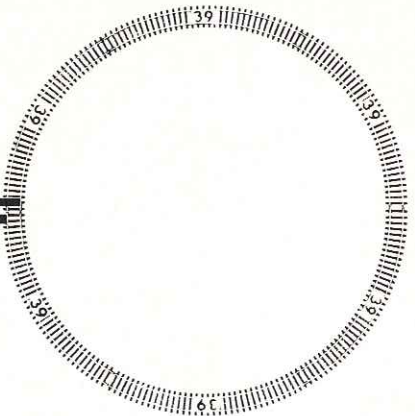
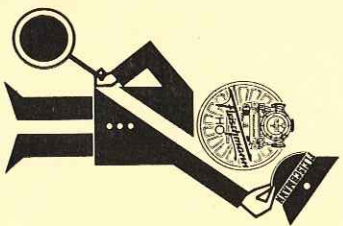

0,60 m x 0,60 m

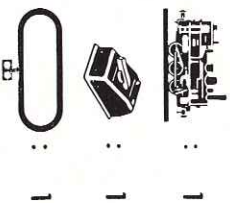

Symb.Nº	39		<b>I</b>
Art. Nº	..06 60		711
	6x 1x		712
			1x

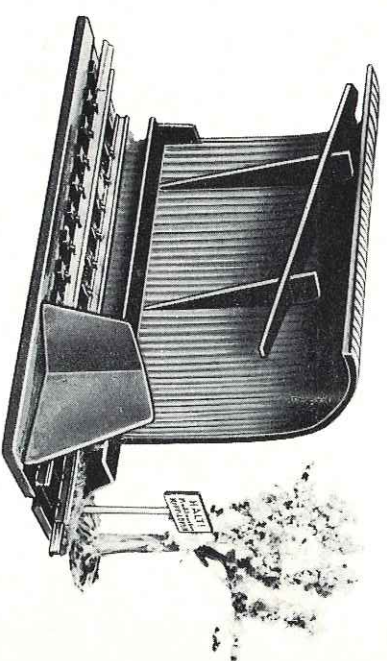

1,00 m x 0,65 m

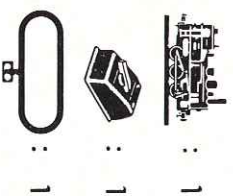

Symb. Nº	2	4	13	22	30	39	45		<b>I</b>
Art. Nº	..00/2	..00/4	..00/2 E	..01½	..03	..06	..22		711
	1x	1x	1x	2x	2x	8x	1 P		712
									1x



**M**  
4203

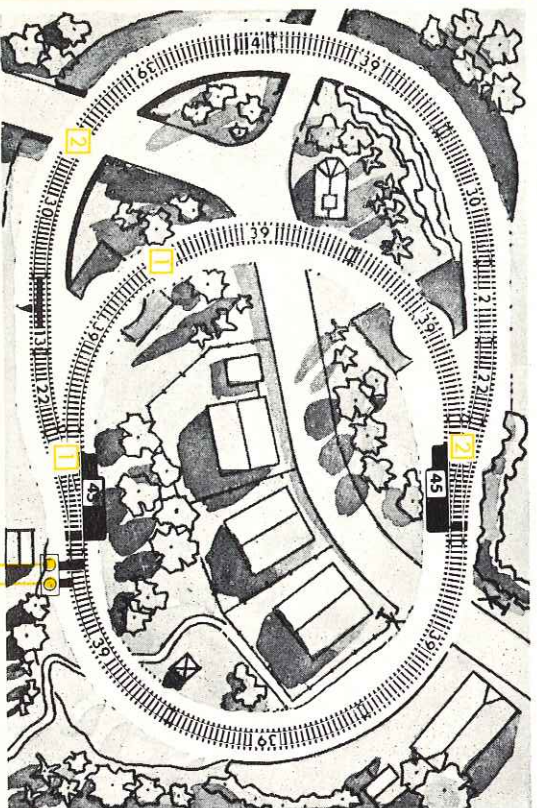

1,35 m x 0,70 m

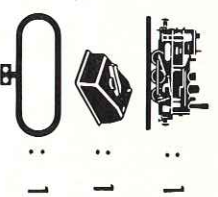

Symb. Nº	1	2	4	5	13
Art. Nº	..00	..00/2	..00/4	..00/5	..00/2 E
	4x	1x	2x	2x	1x

Symb. Nº	30	39	45		<b>I</b>
Art. Nº	..03	..06	..22		711
	4x	10x	2 P		712
					1x

**M**  
4204

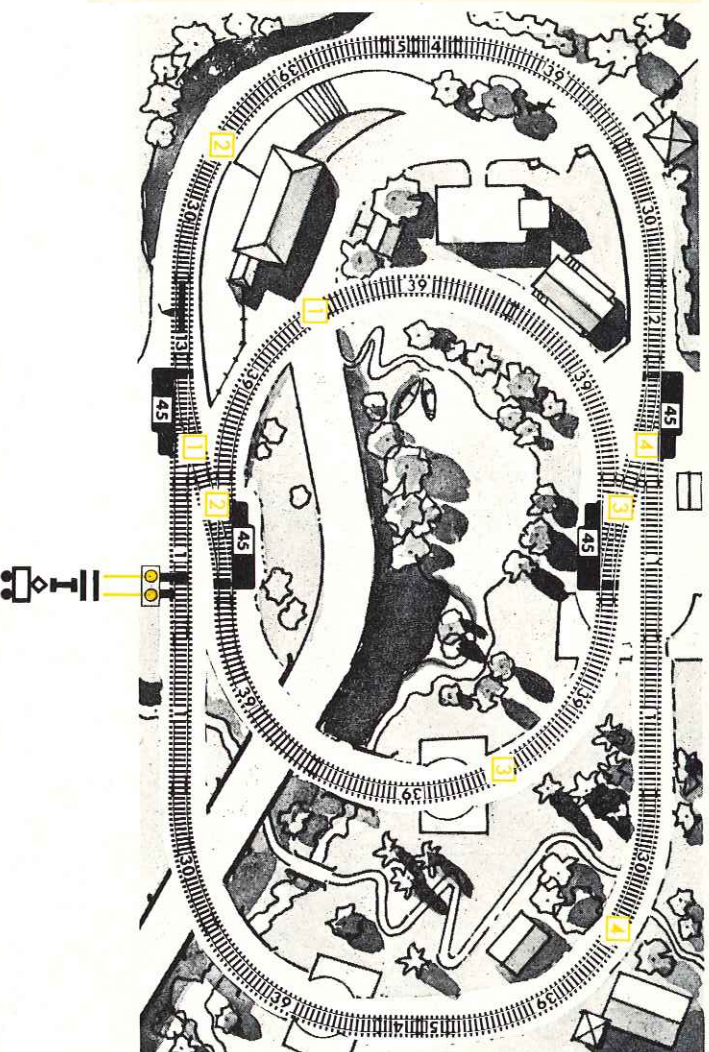

1,50 m x 0,85 m

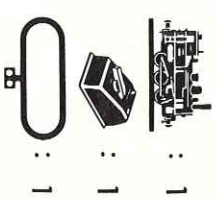

Symb. Nº	1	2	4	5	13
Art. Nº	..00	..00/2	..00/4	..00/5	..00/2 E
	10x	3x	3x	3x	2x

Symb. Nº	19	30	32	39	45
Art. Nº	..88	..03	..03½	..06	..22
	2x	10x	2x	10x	2 P

Symb. Nº	52		67	<b>I</b>
Art. Nº	..25		60	711
	2x		1x	712
				1x

**M**  
4205

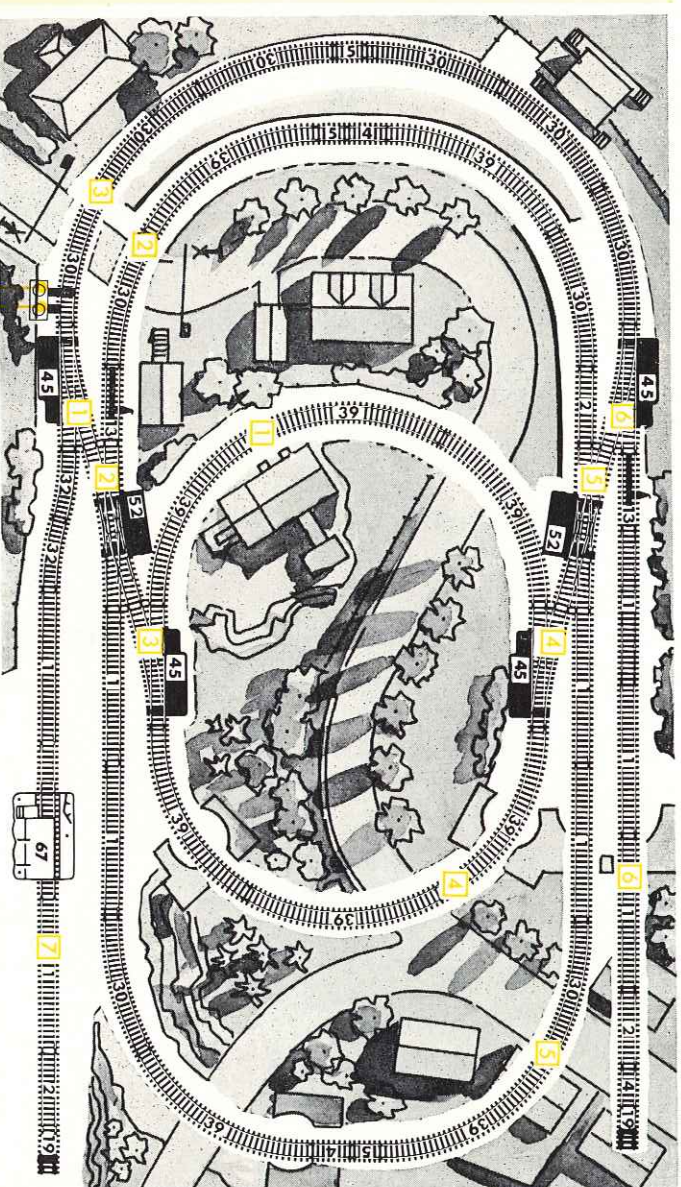



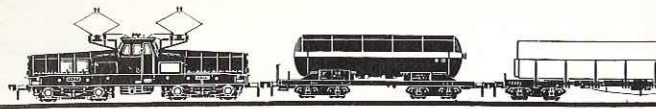



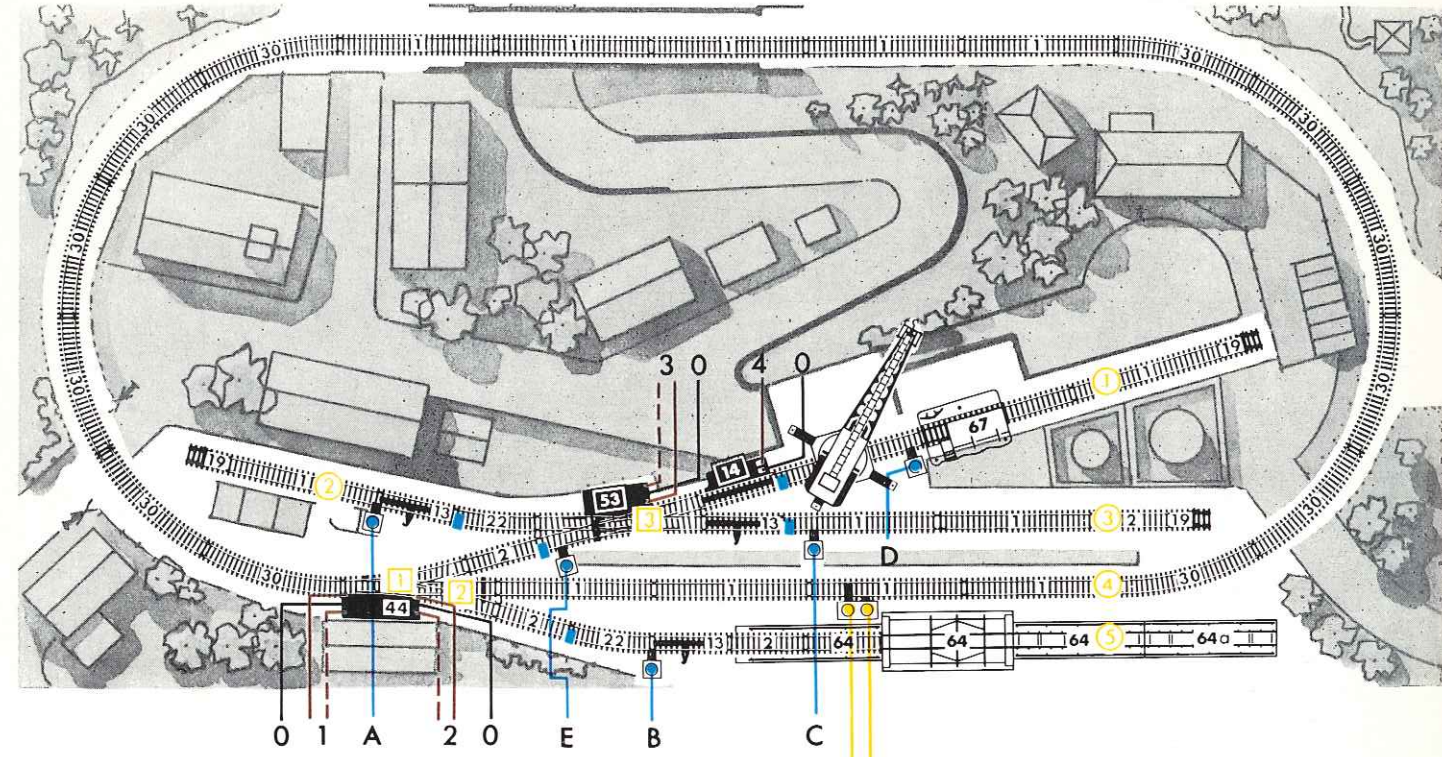
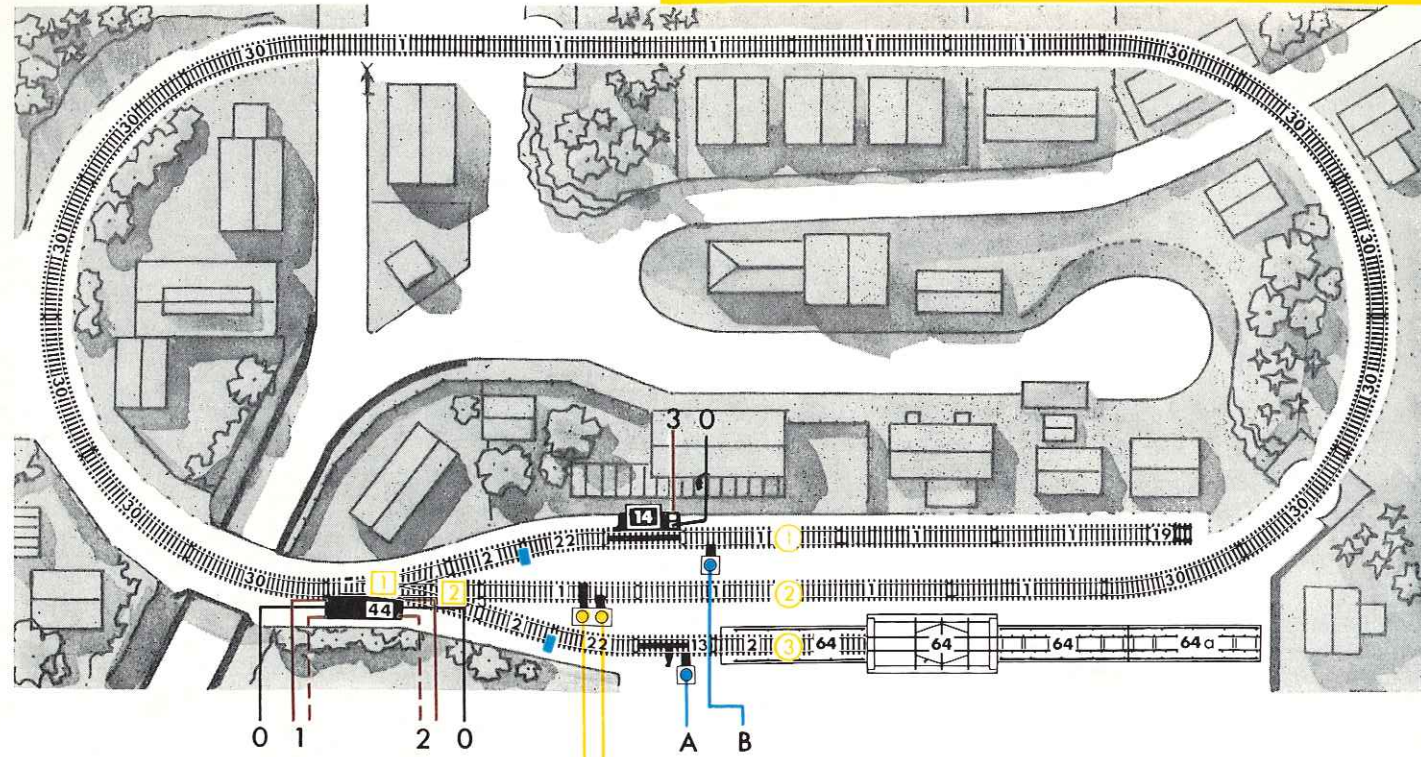
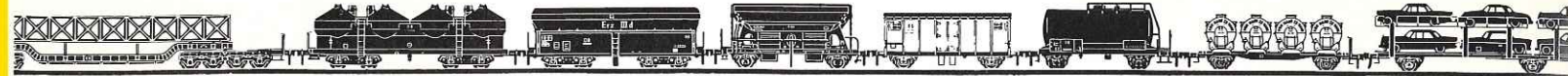

# FLEISCHMANN

international









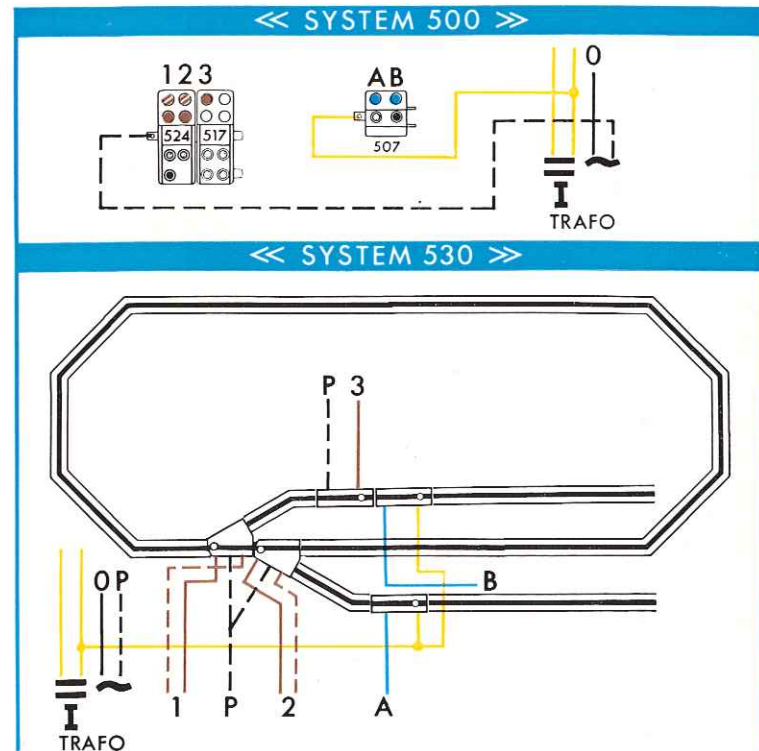



**M**  
4209  
PERFEKT

1,85m x 0,90m

-  : 1
-  : 1
-  : 1





Symb. N°	1	2	13	14	19	22
Art. N°	..00	..00/2	..00/2 E	..00/2 EM	..88	..01½
	12x	3x	1x	1x	1x	2x

Symb. N°	30	44				64	64a								<b>I</b>
Art. N°	..03	..26 A	60	62	78	82	82/1	507	517	524	530	533	538		711 712
	12x	1x	1x	2x	2x	1x	1x	1x	1x	1x	2x	3x	20x		1x







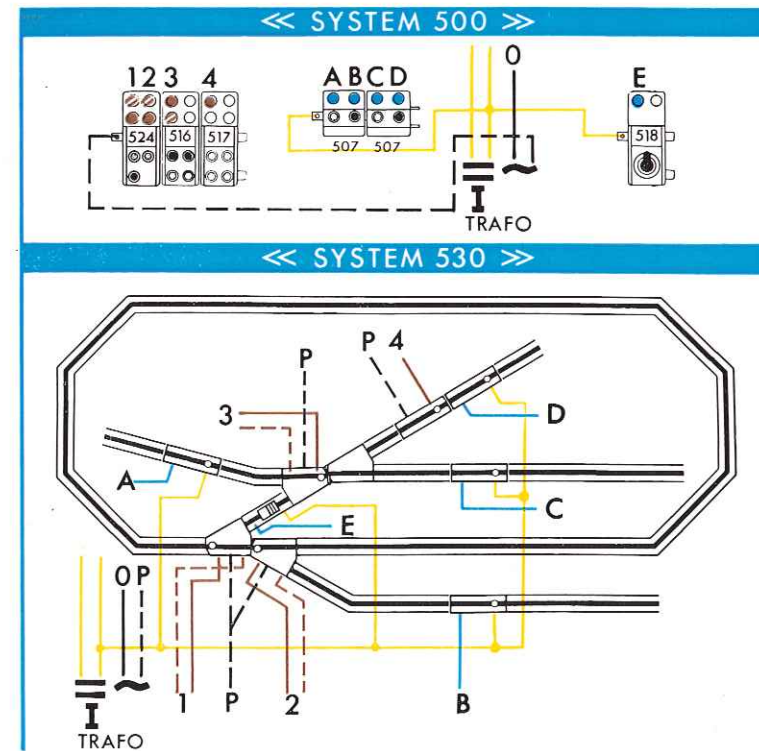



**M**  
4210  
PERFEKT

1,85m x 0,90m

-  : 1-2
-  : 1-2
-  : 1-2



Symb. N°	1	2	13	14	19	22
Art. N°	..00	..00/2	..00/2 E	..00/2 EM	..88	..01½
	15x	4x	3x	1x	3x	2x

Symb. N°	30	44	53				64	64a	67									<b>I</b>		
Art. N°	..03	..26 A	..25 A	60	62	78	82	82/1	67	507	516	517	518	524	530	531	533	536	538	711 712
	12x	1x	1x	1x	5x	5x	1x	1x	1x	2x	1x	1x	1x	1x	3x	1x	5x	1x	23x	1x

# FLEISCHMANN

international

Symb. N°	1	2	4	5	8	13
Art. N°	..00	..00/2	..00/4	..00/5	..10	..00/2 E
	14x	1x	3x	2x	1x	5x



Symb. N°	1	2	13	14	19	22	30	43	44
Art. N°	..00	..00/2	..00/2 E	..00/2 EM	..88	..01½	..03	..23 A	..26 A
	16x	5x	3x	1x	1x	4x	10x	1 P.	1x

Symb. N°				64	64a	67								I
Art. N°	60	62	78	82	82/1	67	507	517	524	530	533	536	538	711 712
	1x	6x	4x	1x	1x	1x	1x	1x	1x	2x	3x	2x	22x	1x

Symb. N°	14	19	22	30	41	53				67												I
Art. N°	..00/2 EM	..88	..01½	..03	..24 A	..25 A	60	62	78	67	515	516	517	518	1771	530	531	532	533	536	538	711 712
	1x	2x	2x	12x	1 P.	1x	1x	6x	5x	1x	2x	2x	1x	2x	2x	3x	2x	2x	1x	1x	20x	1x

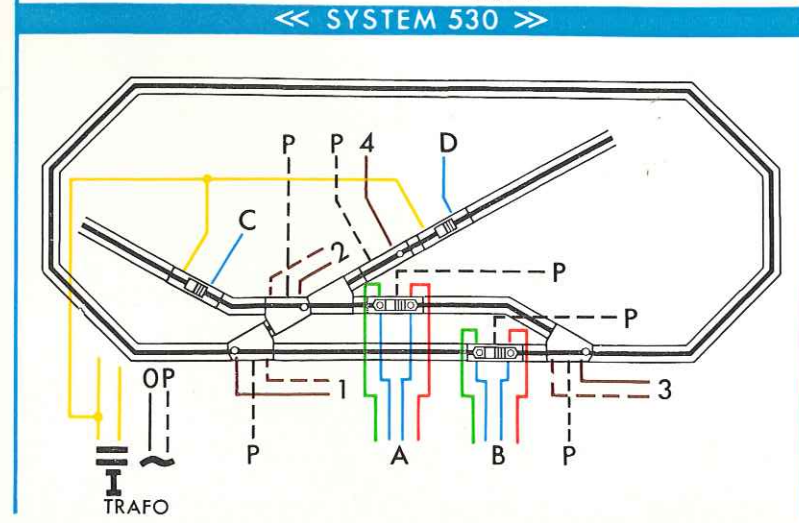
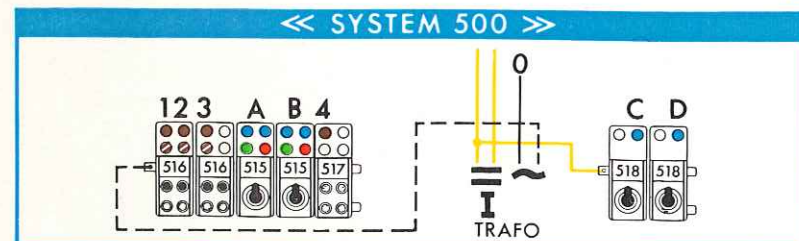
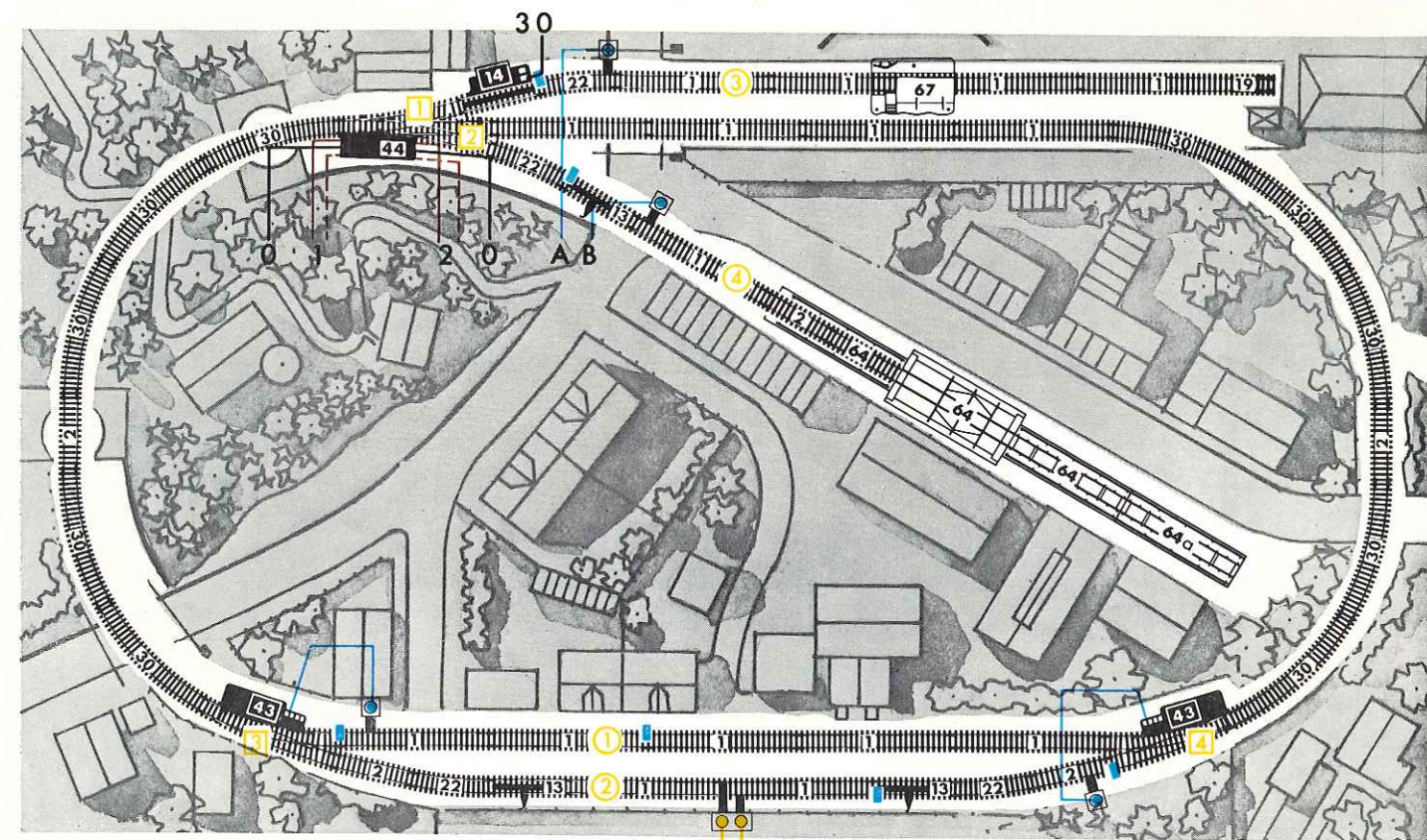
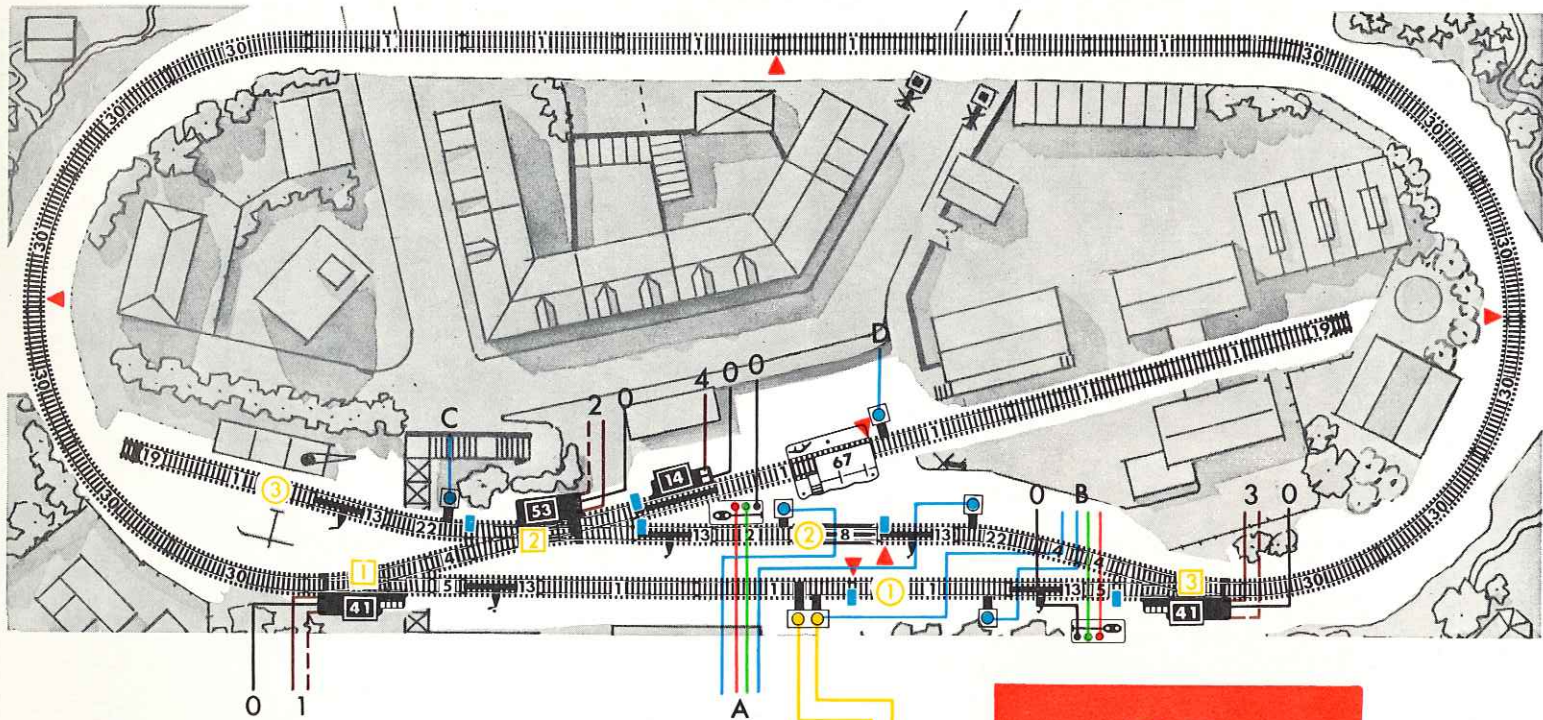

**M**  
4211  
PERFEKT

2,00m x 0,80m

- : 1-2
- : 1
- : 1

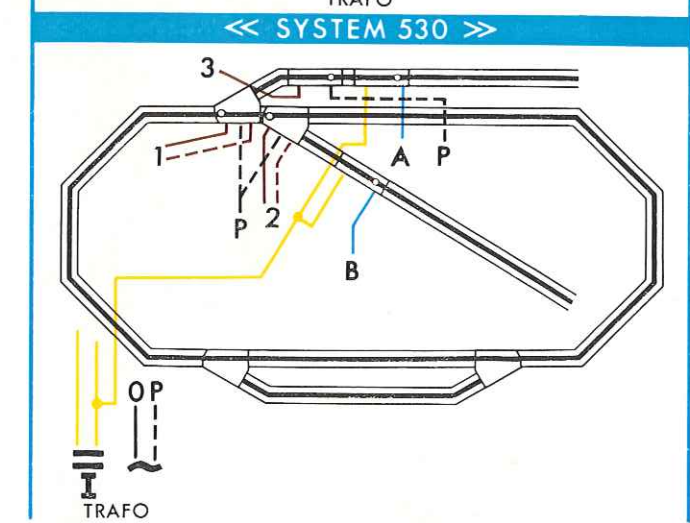
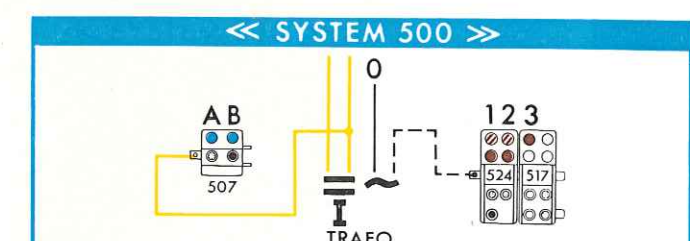

**M**  
4212  
PERFEKT

1,80m x 1,00m

- : 1-2
- : 1
- : 1



# M

## 4213

2,00 m x 0,90 m

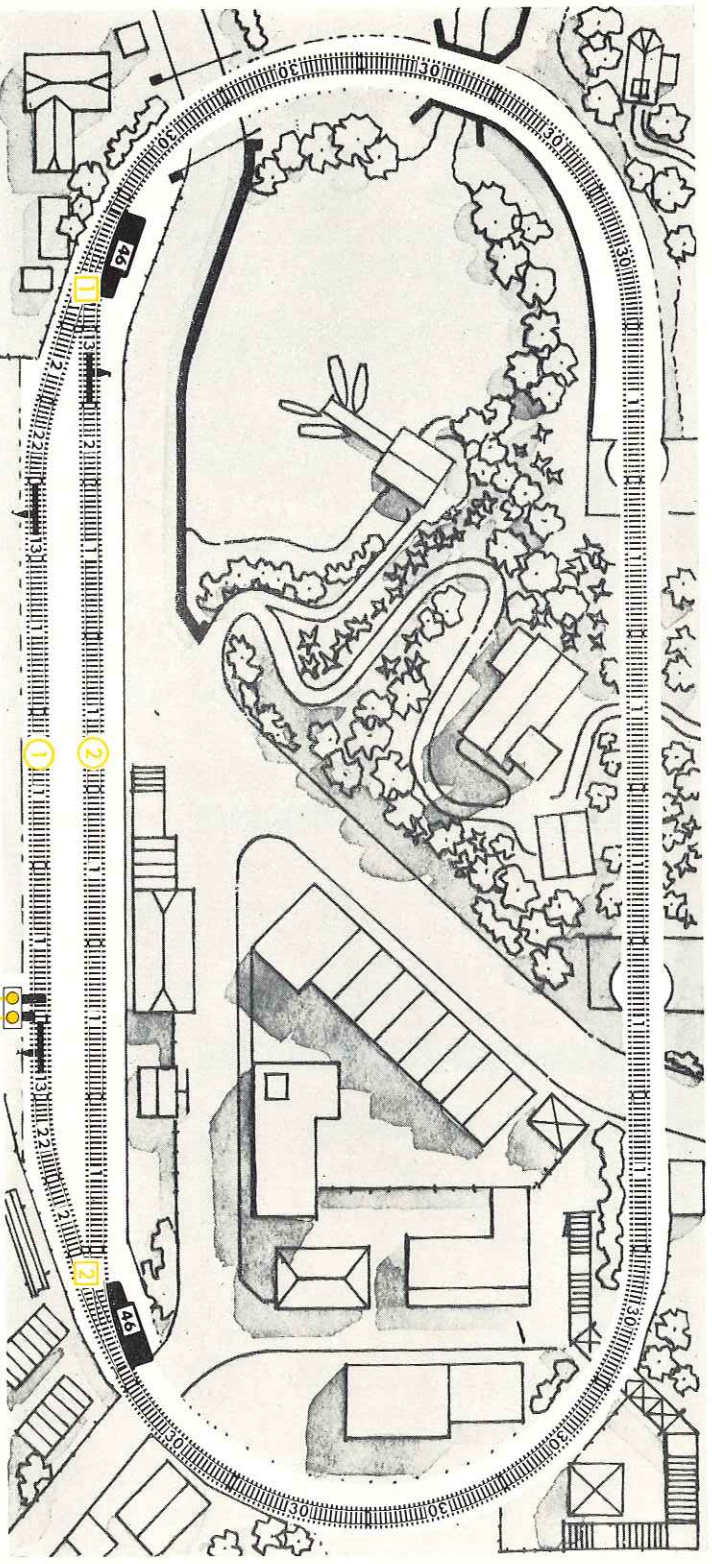
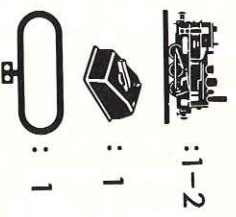

Symb. №	1	2	13	22	30	46	I
Art. №	..00	..00/2	..00/2 E	..01 1/2	..03	..21	711 712
	14x	3x	3x	2x	10x	1 P.	1x



# M

## 4214

### PERFEKT

2,00 m x 0,90 m

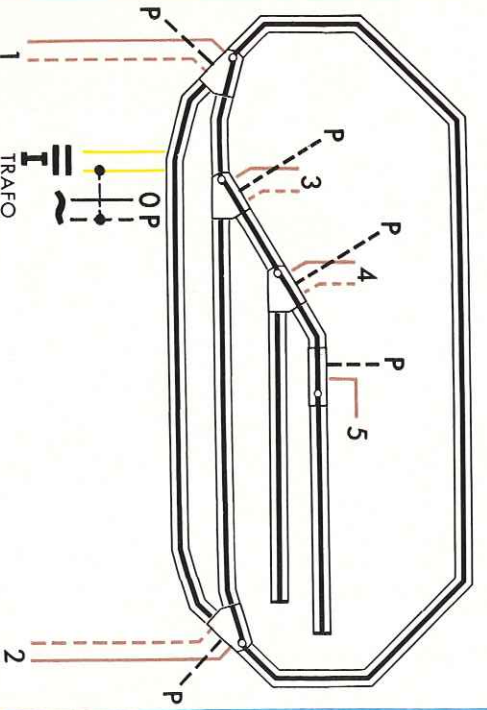
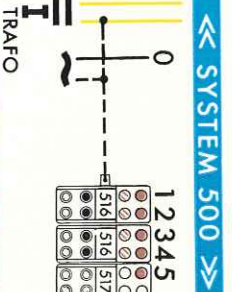
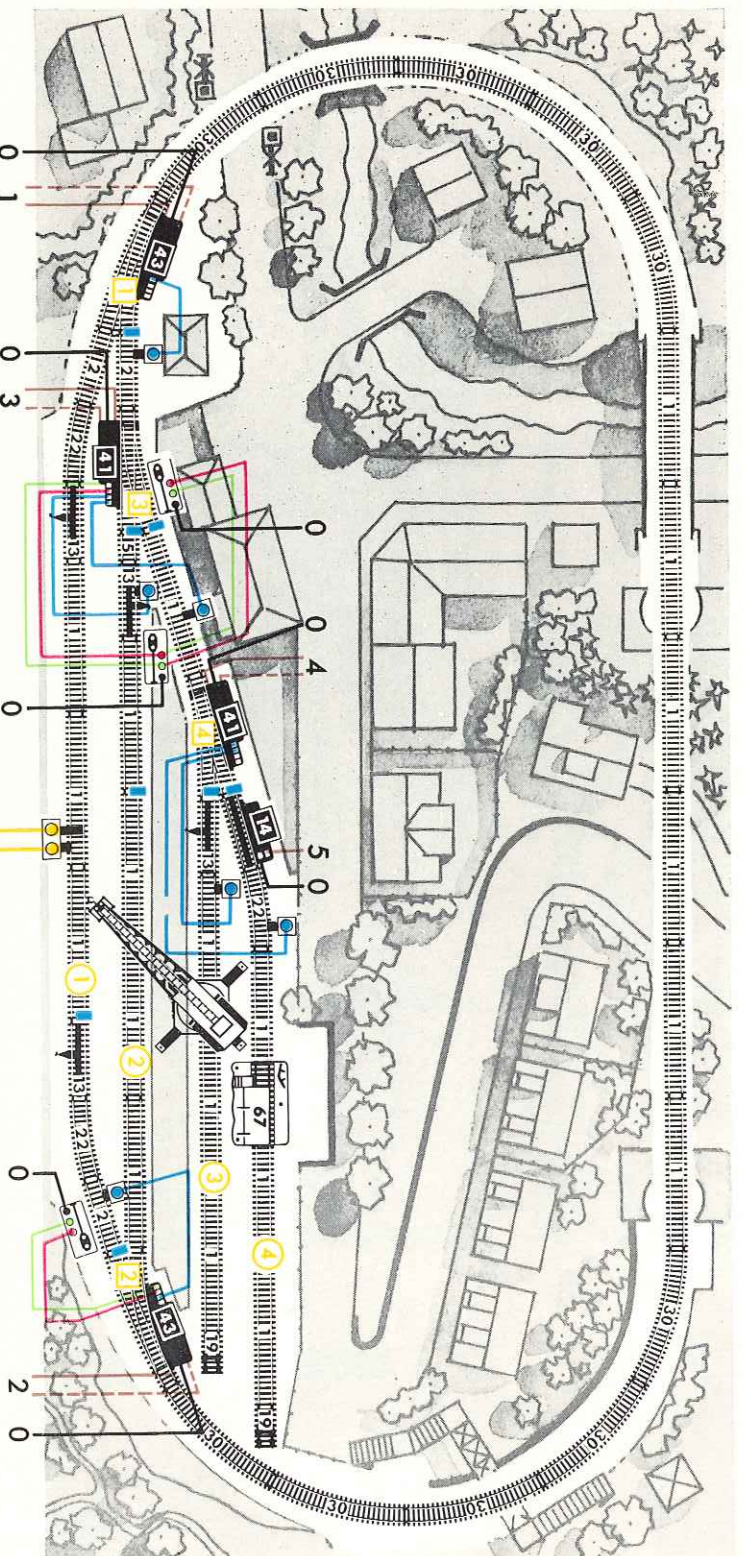
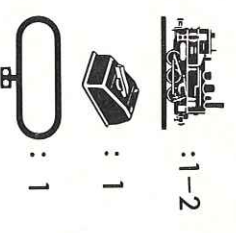

Symb. №	1	2	5	13	14	19	22	30	41	43	I
Art. №	..00	..00/2	..00/5	..00/2 E	..00/2 EM	..88	..01 1/2	..03	..24 A	..23 A	711 712
	20x	3x	1x	4x	1x	2x	3x	10x	1 P.	1 P.	1x

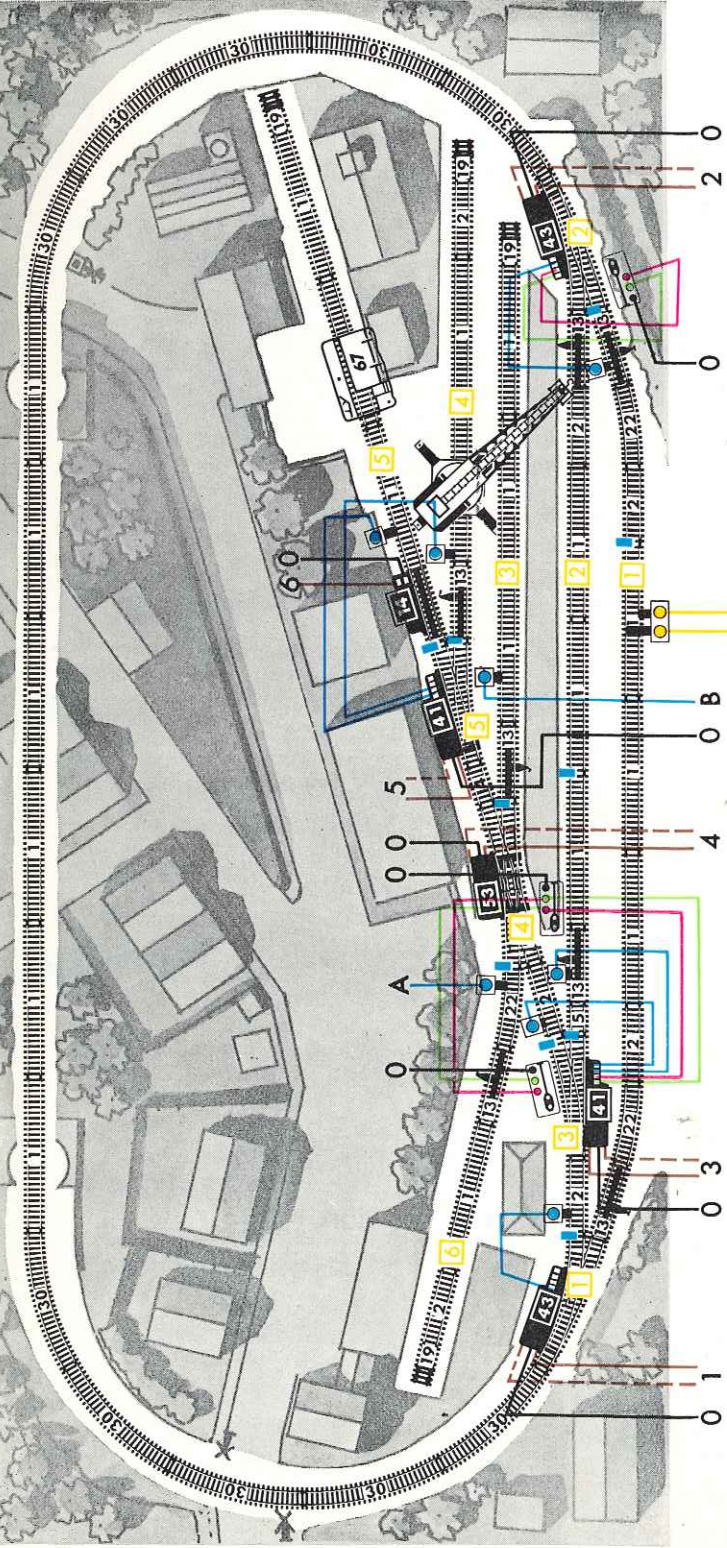

# M

## 4215

### PERFEKT

2,00m x 0,90m



# FLEISCHMANN

international

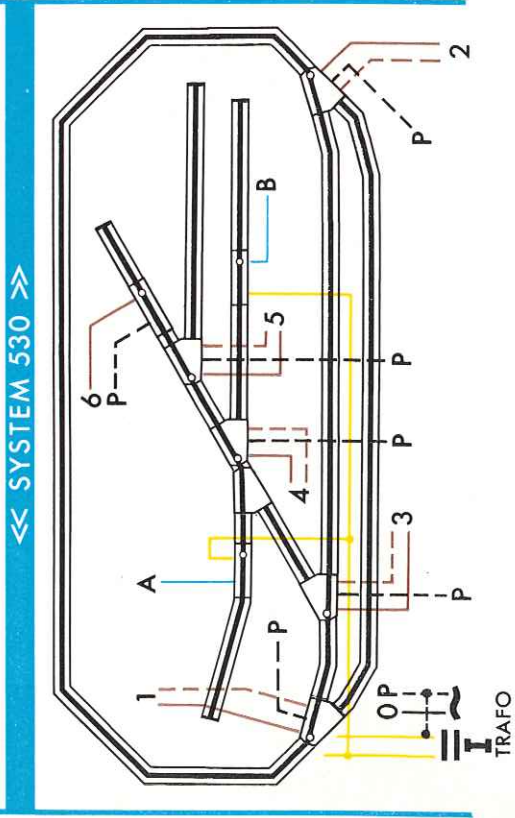
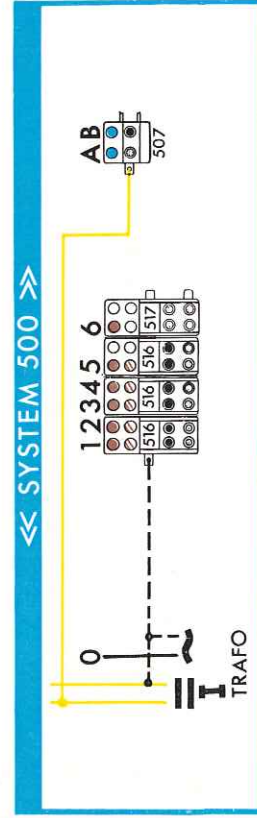

Symb. N°	1	2	4	5	13	14	19	22	30	41	43
Art. N°	..00..00/2 ..00/4 ..00/5 ..00/2 E ..00/2 EM ..88 ..01 1/2 ..03 ..24 A ..23 A										
	21x	7x	1x	1x	7x	1x	4x	3x	10x	1 P.	1 P.

Symb. N°	53	67	507	516	517	571	572							
Art. N°	..25 A 60 62 67 78 507 516 517 1771 530 533 536 538													
	1x	1x	10x	1x	8x	1x	3x	1x	3x	5x	3x	1x	26x	1x

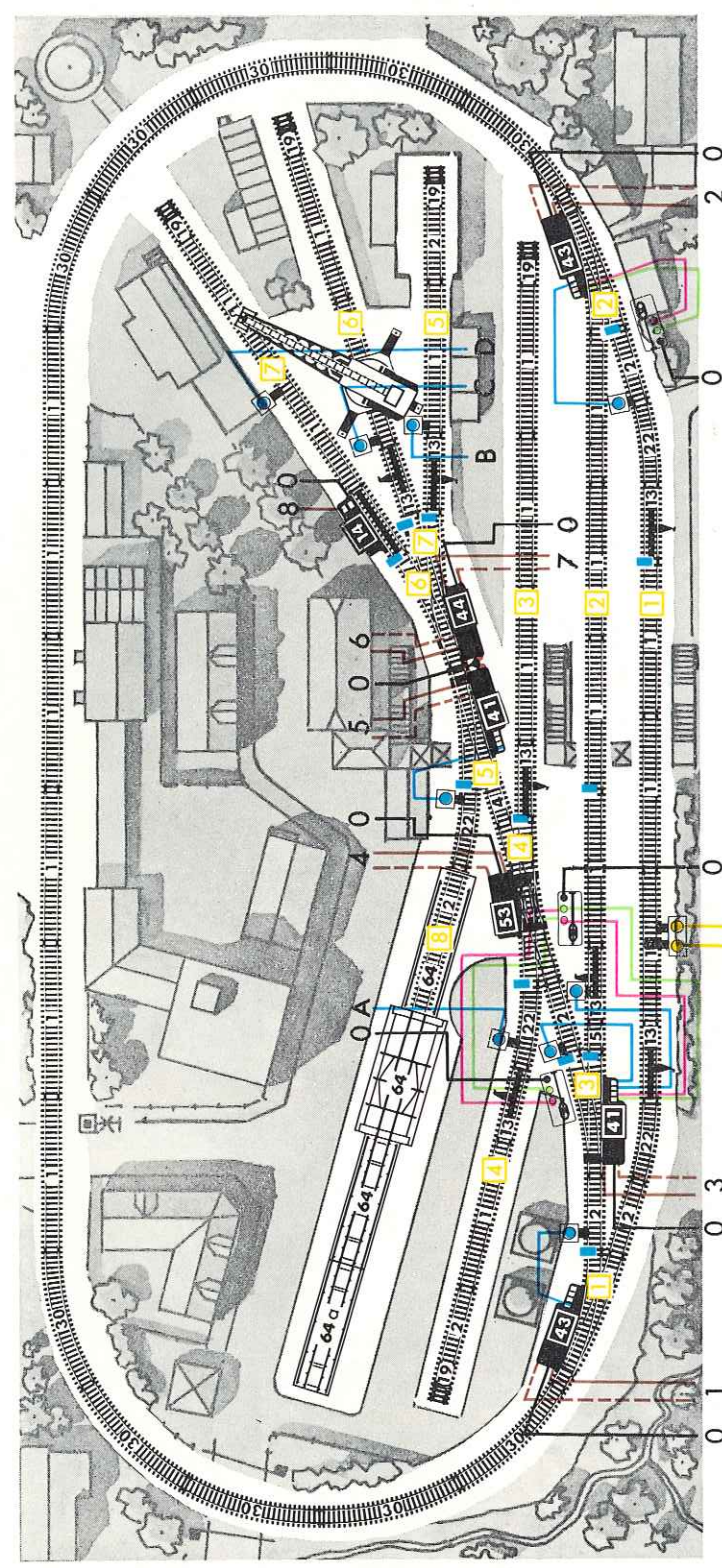

# M

## 4216

### PERFEKT

2,00 m x 0,90 m

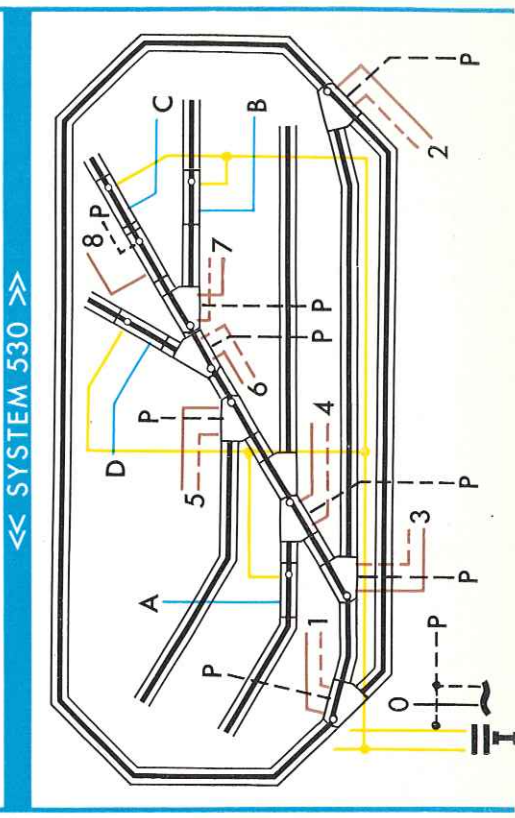
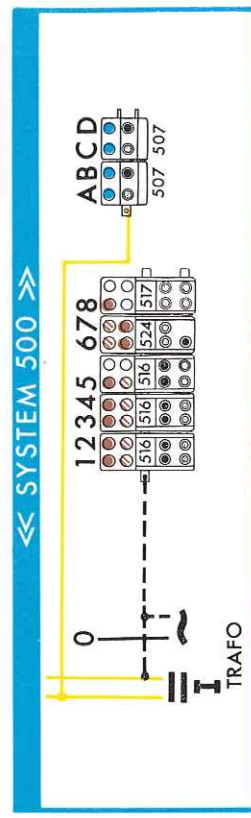

Symb. N°	1	2	4	5	13	14	19	22	30	41	43
Art. N°	..00..00/2 ..00/4 ..00/5 ..00/2 E ..00/2 EM ..88 ..01 1/2 ..03 ..24 A ..23 A										
	22x	7x	1x	1x	7x	1x	5x	4x	10x	1 P.	1 P.

Symb. N°	44	53	67	64	64a	507	516	517	524								
Art. N°	..26 A ..25 A 60 62 78 82 82/1 507 516 517 524 1771 530 533 536 538																
	1x	1x	1x	12x	9x	1x	1x	2x	3x	1x	1x	3x	7x	5x	1x	29x	1x

# M

## 4216

### PERFEKT

2,00 m x 0,90 m

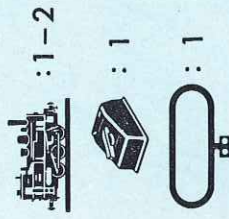

Symb. N°	1	2	4	5	13	14	19	22	30	41	43					
Art. N°	..00	..00/2	..00/4	..00/5	..00/2 E	..00/2 EM	..88	..01½	..03	..24 A	..23 A					
	22x	7x	1x	1x	7x	1x	5x	4x	10x	1 P.	1 P.					
Symb. N°	44	53	64	64α	507	516	517	524			I					
Art. N°	..26 A	..25 A	60	62	78	82	82/1	507	516	517	524	1771	530	533	536	538
	1x	1x	1x	12x	9x	1x	1x	2x	3x	1x	1x	3x	7x	5x	1x	29x

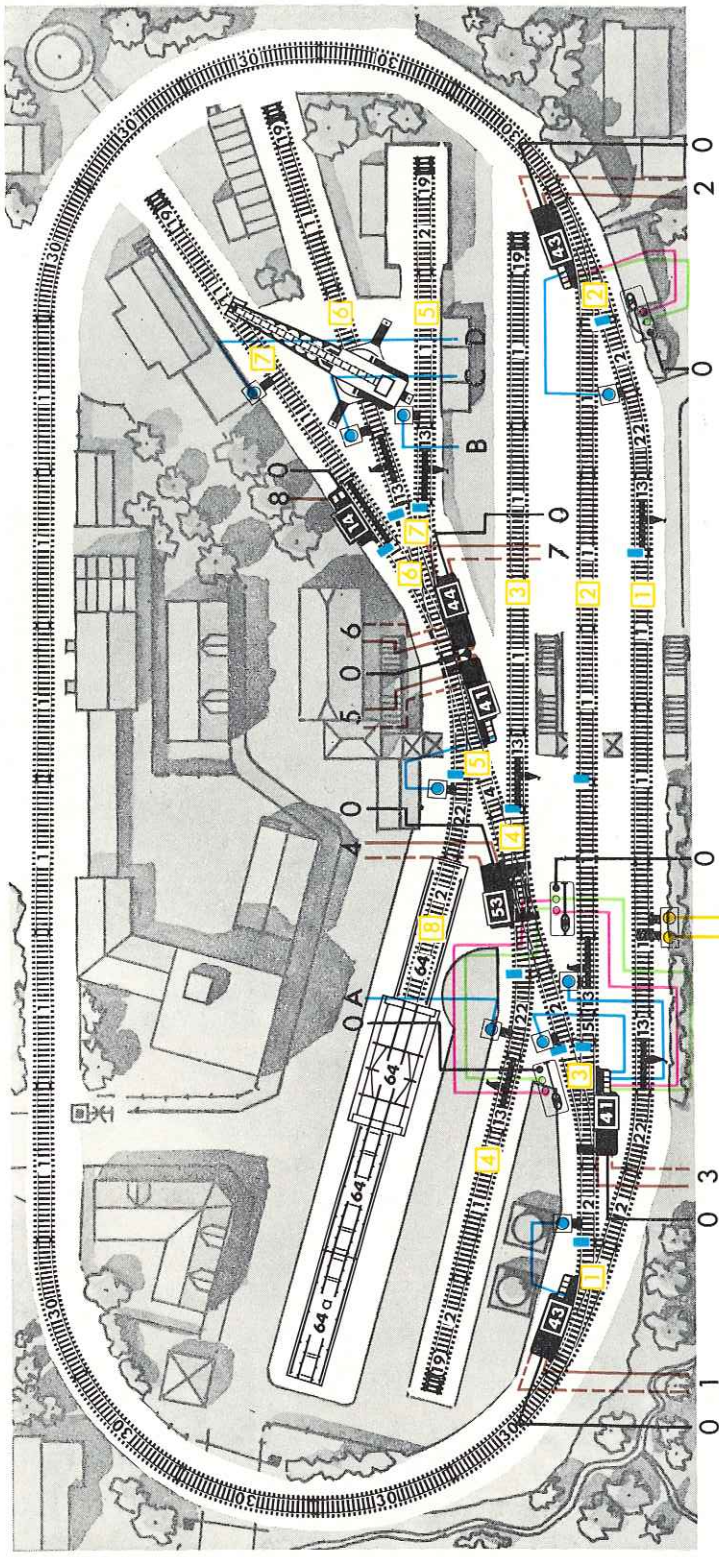
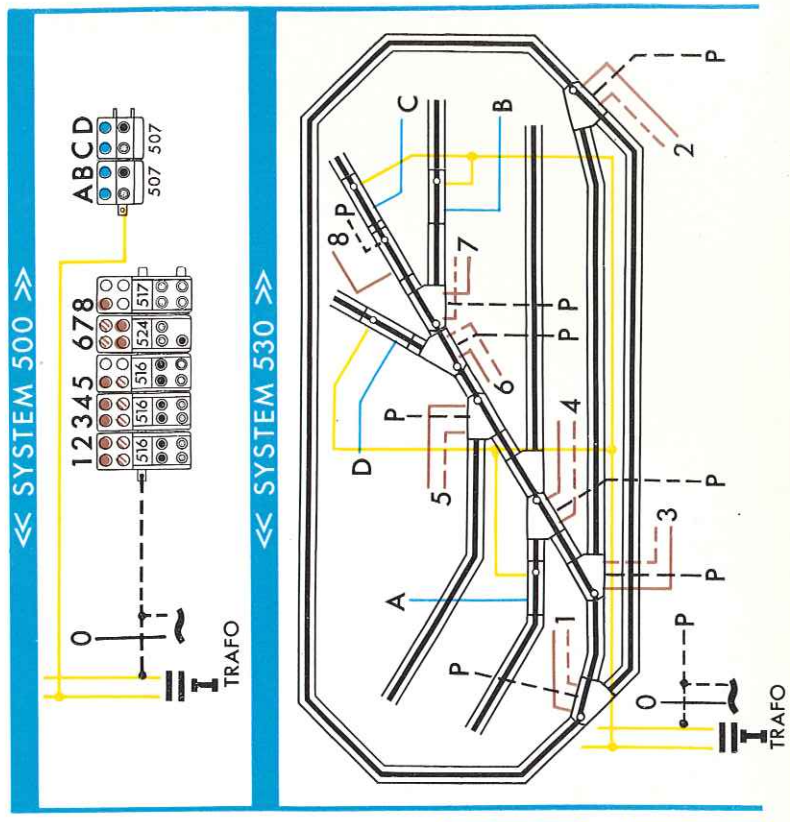



# M

## 4217

1,80m x 0,75m

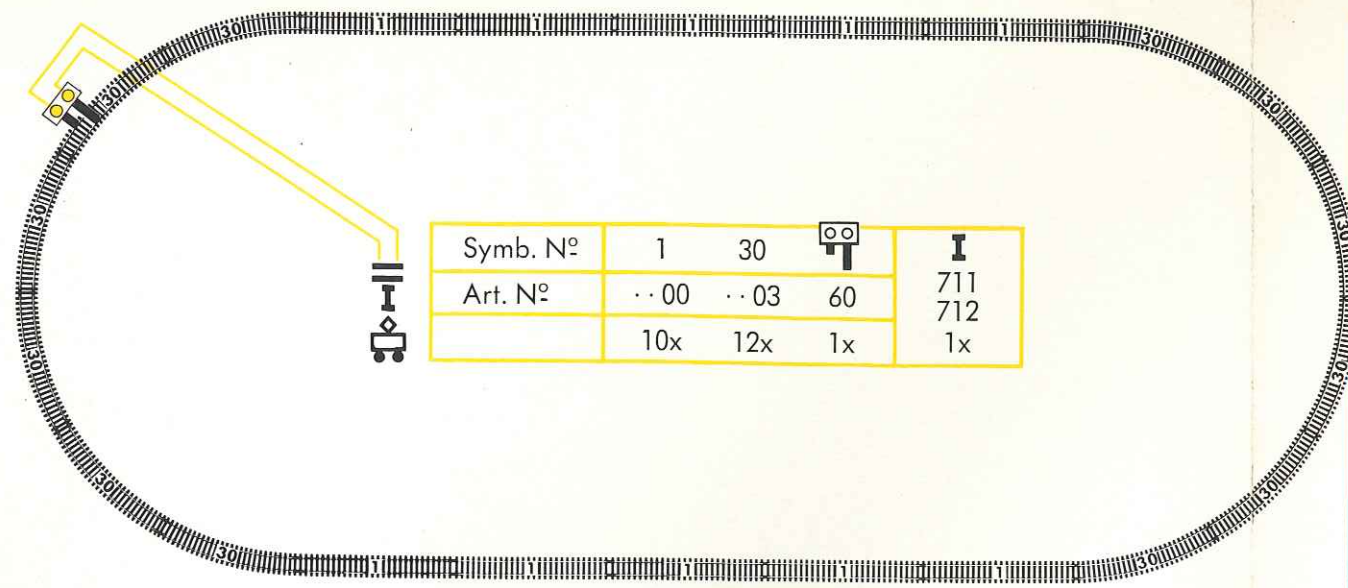
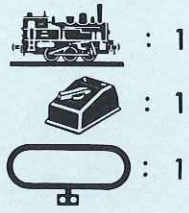

Symb. N°	1	30		<b>I</b>
Art. N°	· · 00	· · 03	60	711 712
	10x	12x	1x	1x

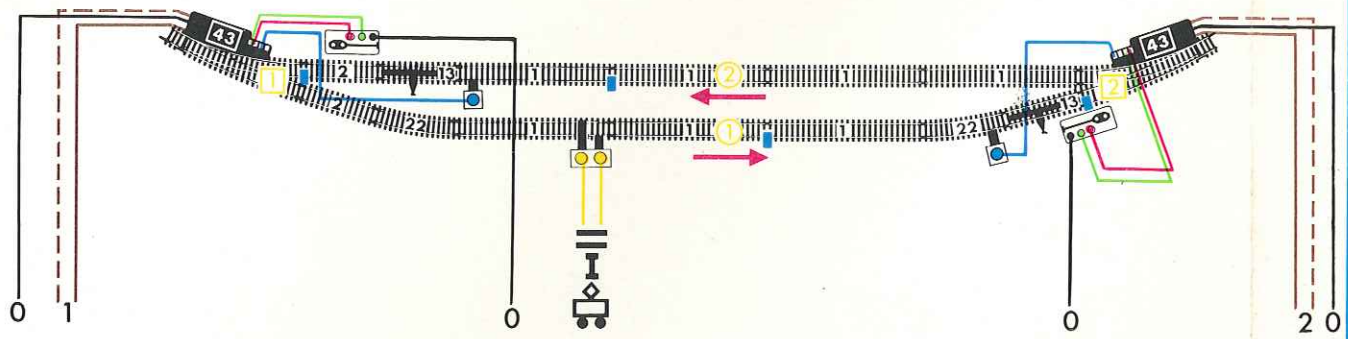

# M

## 4218

PERFEKT

1,40m x 0,15m

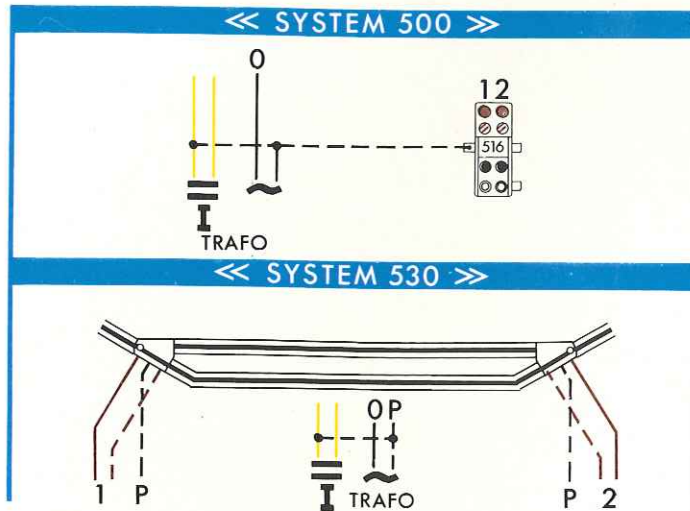
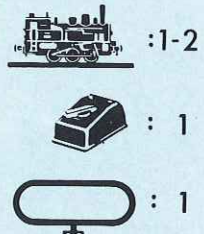

Symb. N°	1	2	13	22	43
Art. N°	· · 00	· · 00/2	· · 00/2E	· · 01½	· · 23 A
	7x	2x	2x	2x	1 P.

							<b>I</b>
60	62	78	516	1771	530	538	711 712
1x	4x	2x	1x	2x	2x	7x	1x

# M

## 4220

PERFEKT

1,40m x 0,25m

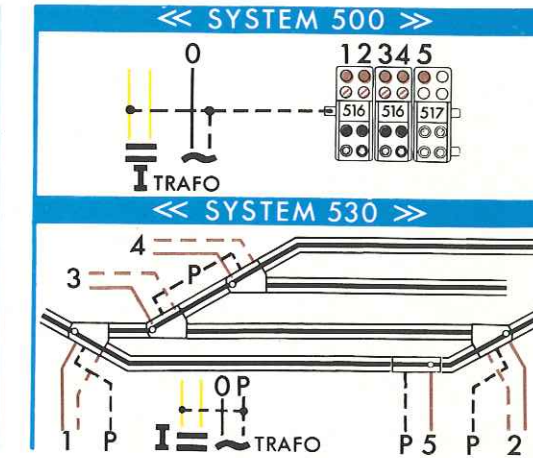
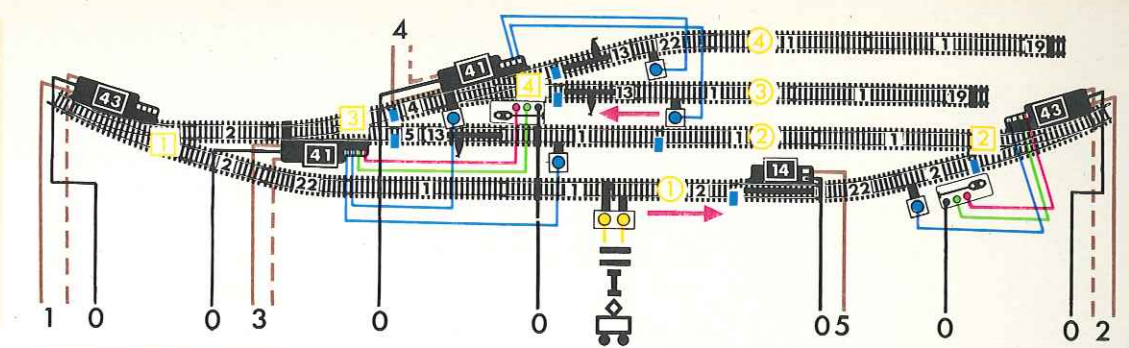
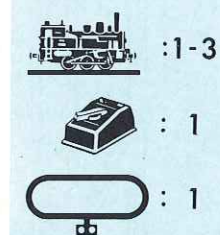

Symb. N°	1	2	4	5	13
Art. N°	· · 00	· · 00/2	· · 00/4	· · 00/5	· · 00/2E
	9x	4x	1x	1x	3x

14	19	22	41	43
· · 00/2EM	· · 88	· · 01½	· · 24 A	· · 23 A
1x	2x	3x	1 P.	1 P.

								<b>I</b>
62	78	516	517	1771	530	533	538	711 712
7x	5x	2x	1x	2x	4x	1x	10x	1x

# M

## 4221

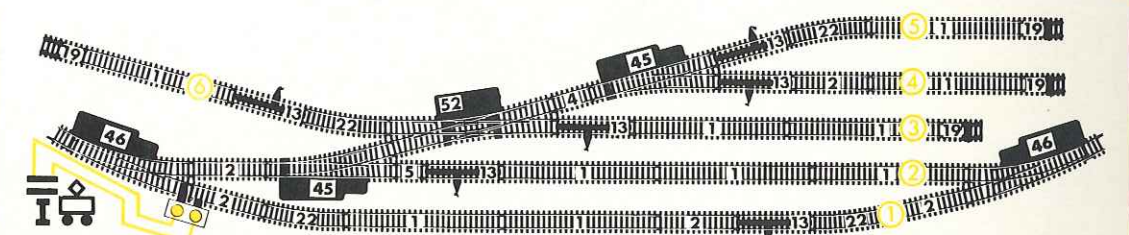

Symb. N°	1	2	4	5	13	19	22	45	46	52		<b>I</b>
Art. N°	· · 00	· · 00/2	· · 00/4	· · 00/5	· · 00/2E	· · 88	· · 01½	· · 22	· · 21	· · 25	60	711 712
	10x	5x	1x	1x	6x	4x	4x	1 P.	1 P.	1x	1x	1x

# M

## 4222

PERFEKT

1,40m x 0,30m

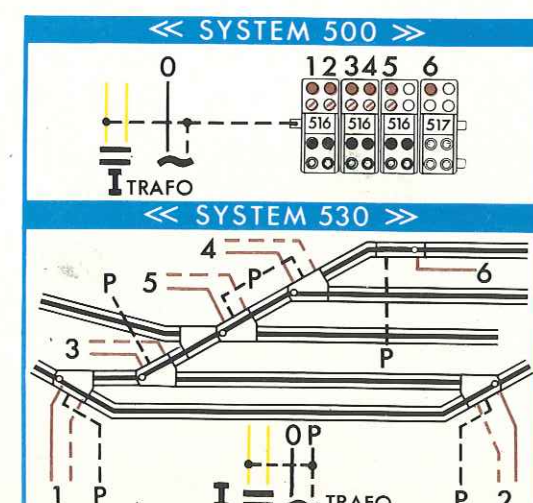
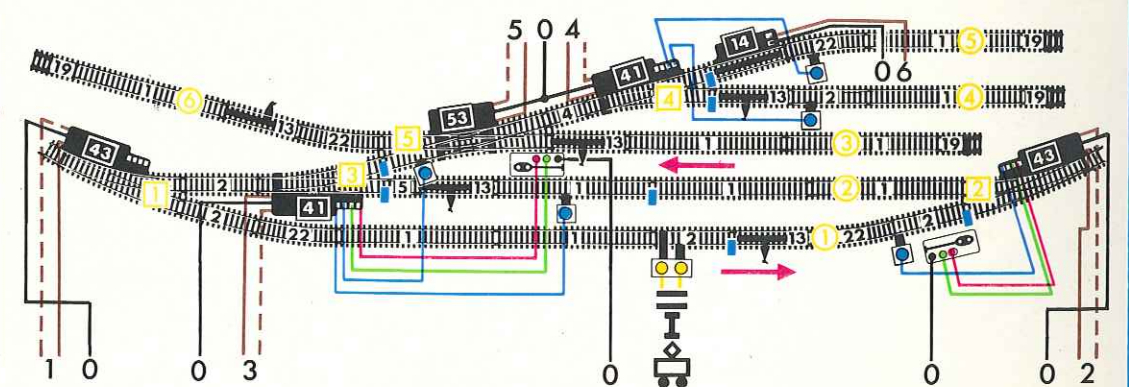
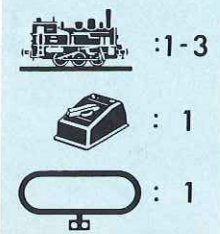

Symb. N°	1	2	4	5
Art. N°	· · 00	· · 00/2	· · 00/4	· · 00/5
	10x	5x	1x	1x

13	14	19	22	41
· · 00/2E	· · 00/2EM	· · 88	· · 01½	· · 24 A
5	1x	4x	4	1 P.

									<b>I</b>
43	53	62	78	516	517	1771	530	533	711 712
1 P.	1x	1x	7x	5x	3x	1x	2x	5x	1x

# M

## 4219

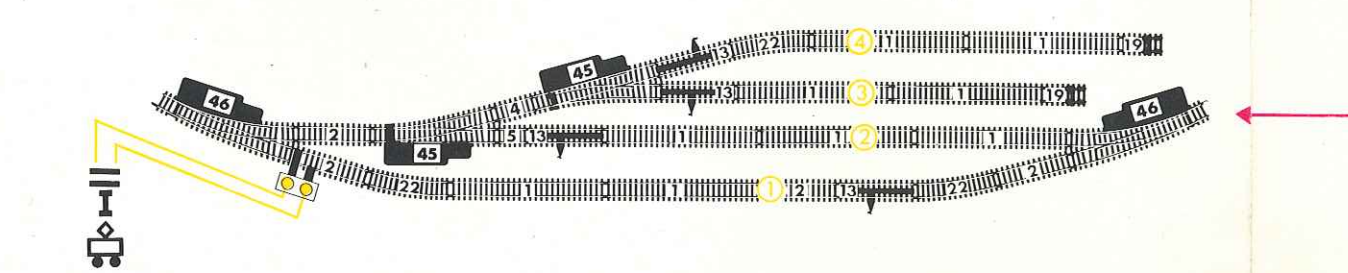

Symb. N°	1	2	4	5	13	19	22	45	46		<b>I</b>
Art. N°	· · 00	· · 00/2	· · 00/4	· · 00/5	· · 00/2E	· · 88	· · 01½	· · 22	· · 21	60	711 712
	9x	4x	1x	1x	4x	2x	3x	1 P.	1 P.	1x	1x

# M

## 4220 PERFEKT

1,40 m x 0,25 m



: 1-3



: 1



: 1

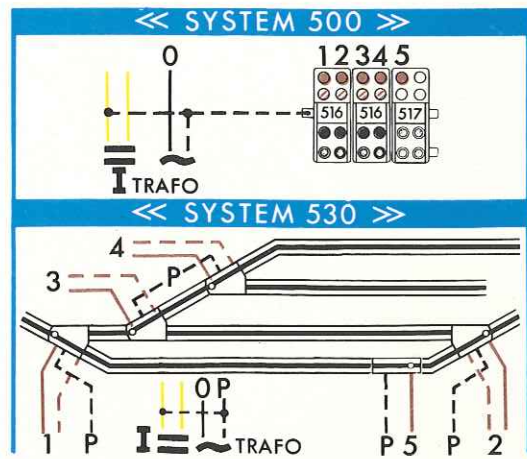
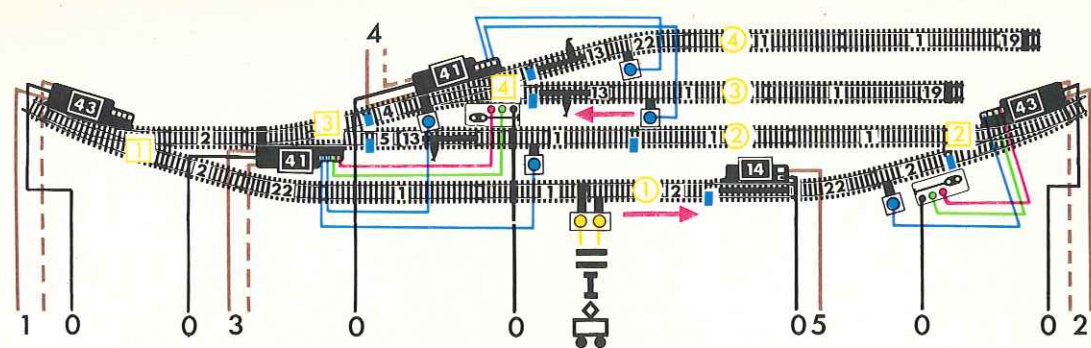

Symb.Nº	1	2	4	5	13
Art. N°	..00	..00/2	..00/4	..00/5	..00/2E
	9x	4x	1x	1x	3x

	14	19	22	41	43
	..00/2EM	..88	..01½	..24A	..23A 60
	1x	2x	3x	1P.	1P. 1x

	62	78	516	517	1771	530	533	538	I
	7x	5x	2x	1x	2x	4x	1x	10x	711
									712
									1x

# M

## 4221

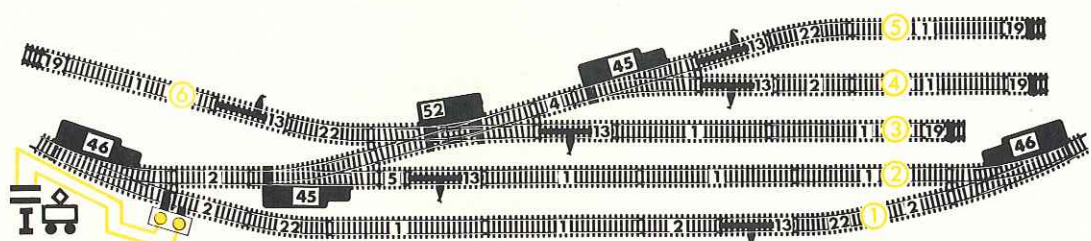

Symb.Nº	1	2	4	5	13	19	22	45	46	52	I
Art.N°	..00	..00/2	..00/4	..00/5	..00/2E	..88	..01½	..22	..21	..25 60	711
	10x	5x	1x	1x	6x	4x	4x	1P.	1P.	1x 1x	712
											1x

# M

## 4222 PERFEKT

1,40 m x 0,30 m



: 1-3



: 1



: 1

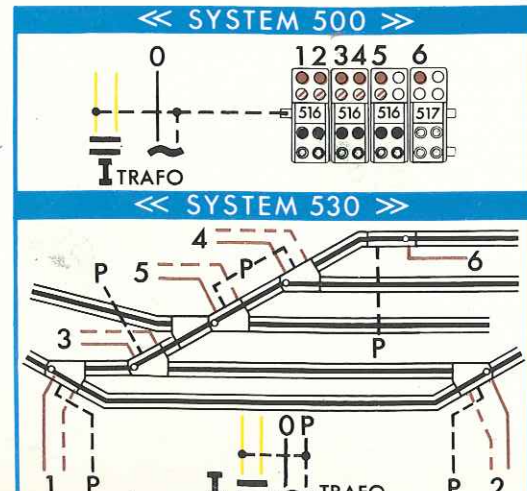
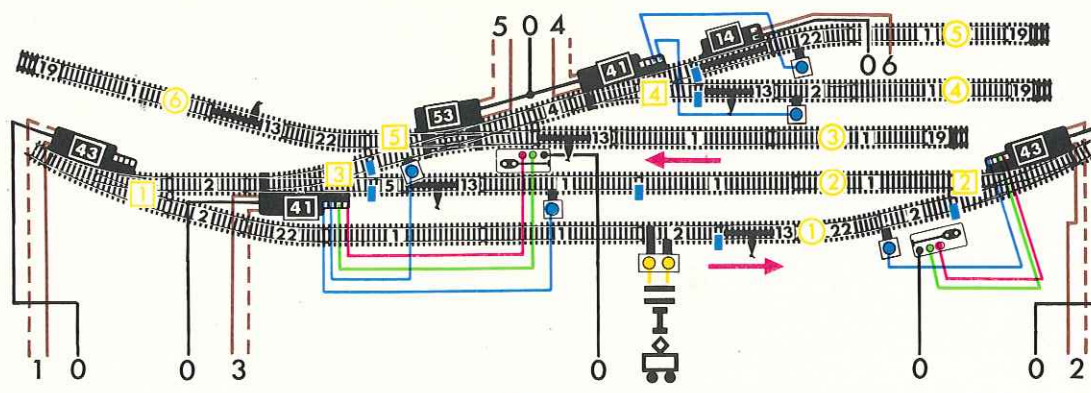

Symb. N°	1	2	4	5
Art. N°	..00	..00/2	..00/4	..00/5
	10x	5x	1x	1x

	13	14	19	22	41
	..00/2E	..00/2EM	..88	..01½	..24A
	5	1x	4x	4	1P.

	43	53	516	517	1771	530	533	536	538	I	
	..23A	..25A 60	62	78	516	517	1771	530	533	536	538
	1P.	1x	1x	7x	5x	3x	1x	2x	5x	1x	1x
											12x
											1x

# M

## 4223

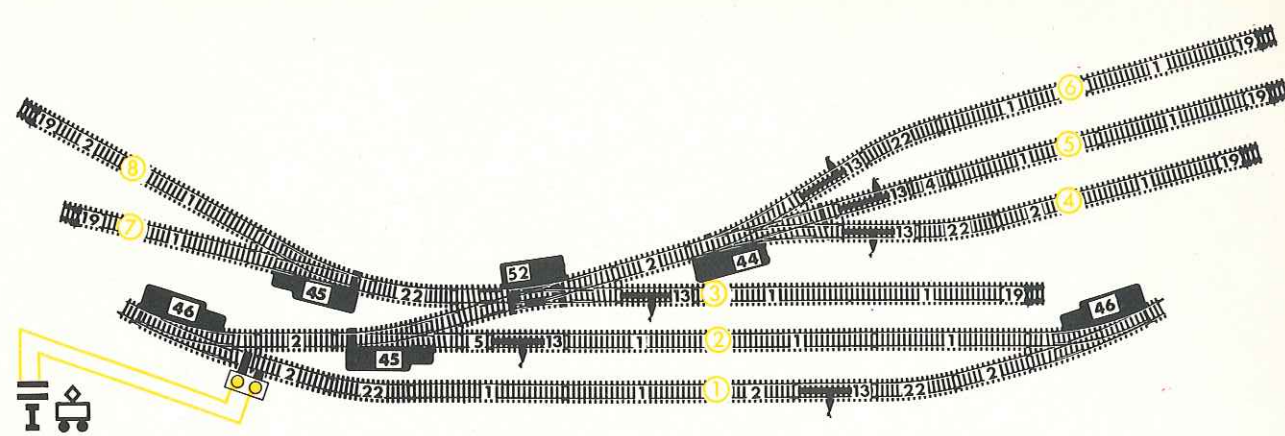

Symb. N°	1	2	4	5	13	19	22	44	45	46	52	I
Art. N°	..00	..00/2	..00/4	..00/5	..00/2E	..88	..01½	..26A	..22	..21	..25 60	711
	14x	7x	1x	1x	6x	6x	5x	1x	1P.	1P.	1x 1x	712
												1x

# M

## 4224

### PERFEKT

1,70 m x 0,50 m



: 1-5



: 1



: 1

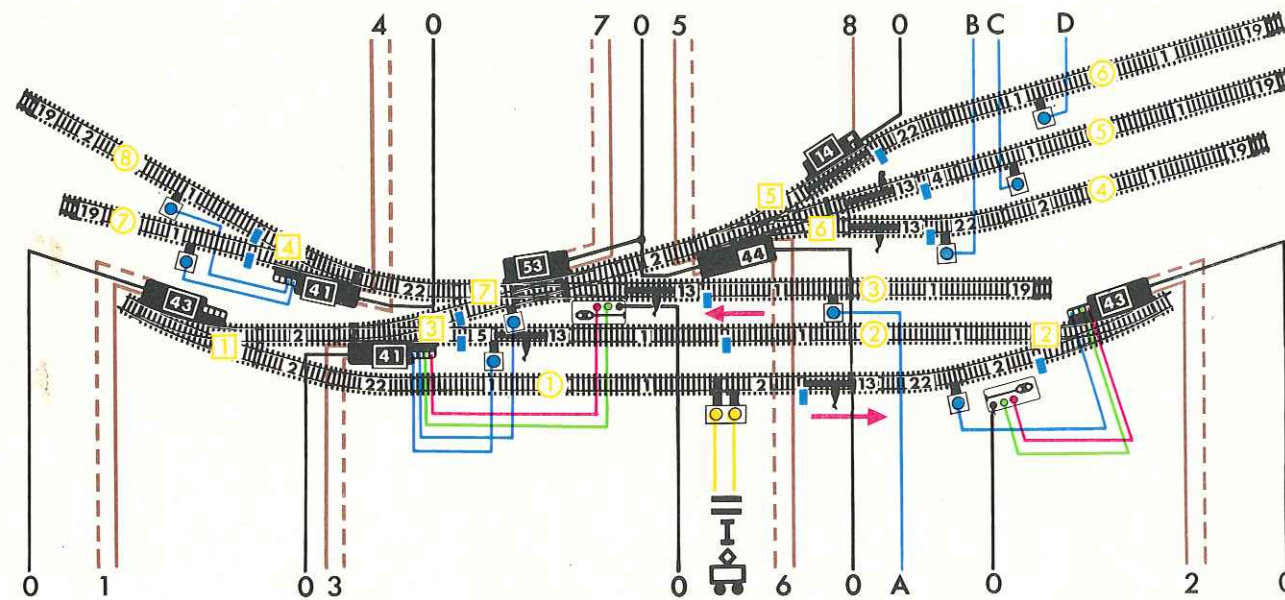

Symb. N°	1	2	4	5
Art. N°	..00	..00/2	..00/4	..00/5
	14x	7x	1x	1x

	13	14	19	22	41
	..00/2E	..00/2EM	..88	..01½	..24A
	5x	1x	6x	5x	1P.

	43	44	53	516	517	518	1771	530	531	533	536	538	I	
	..23A	..26A	..25A 60	62	78	516	517	518	1771	530	531	533	536	538
	1P.	1x	1x	1x	10x	9x	3x	1x	4x	2x	7x	4x	1x	1x
														17x
														1x

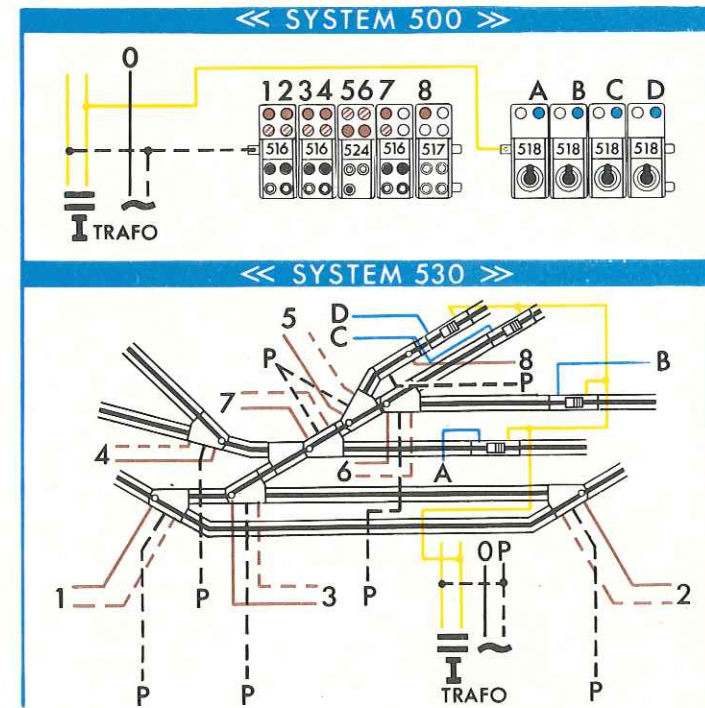

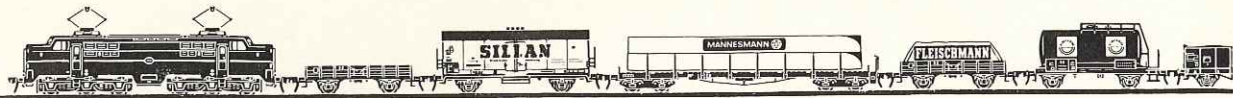

# FLEISCHMANN

international



# M

## 4225

### PERFEKT

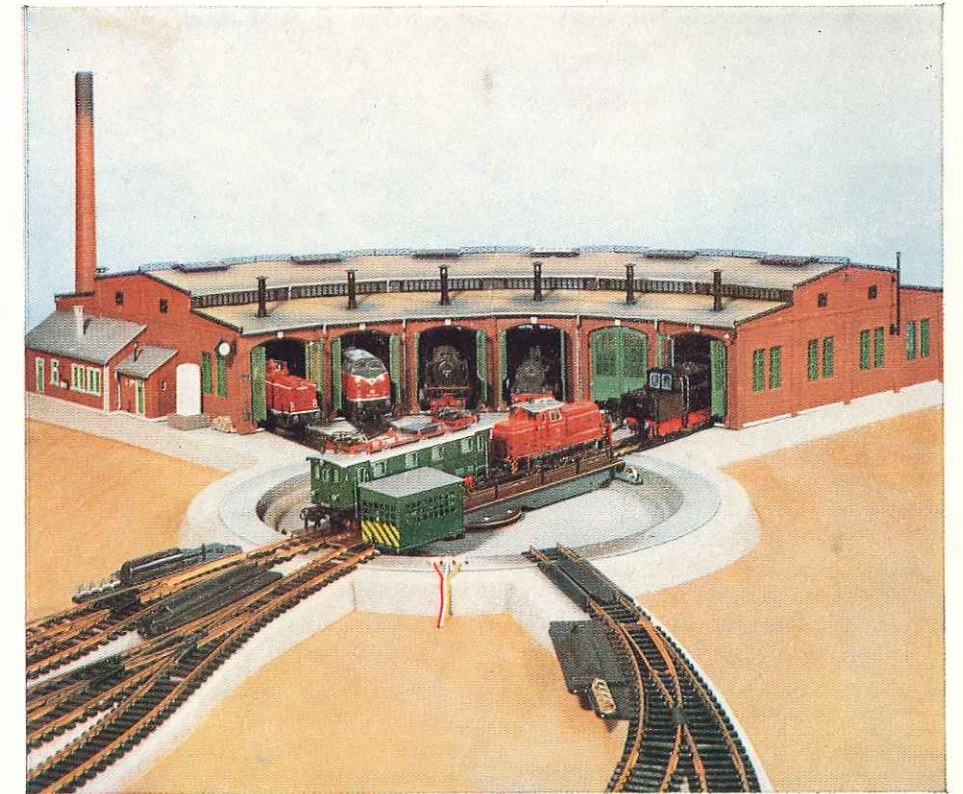
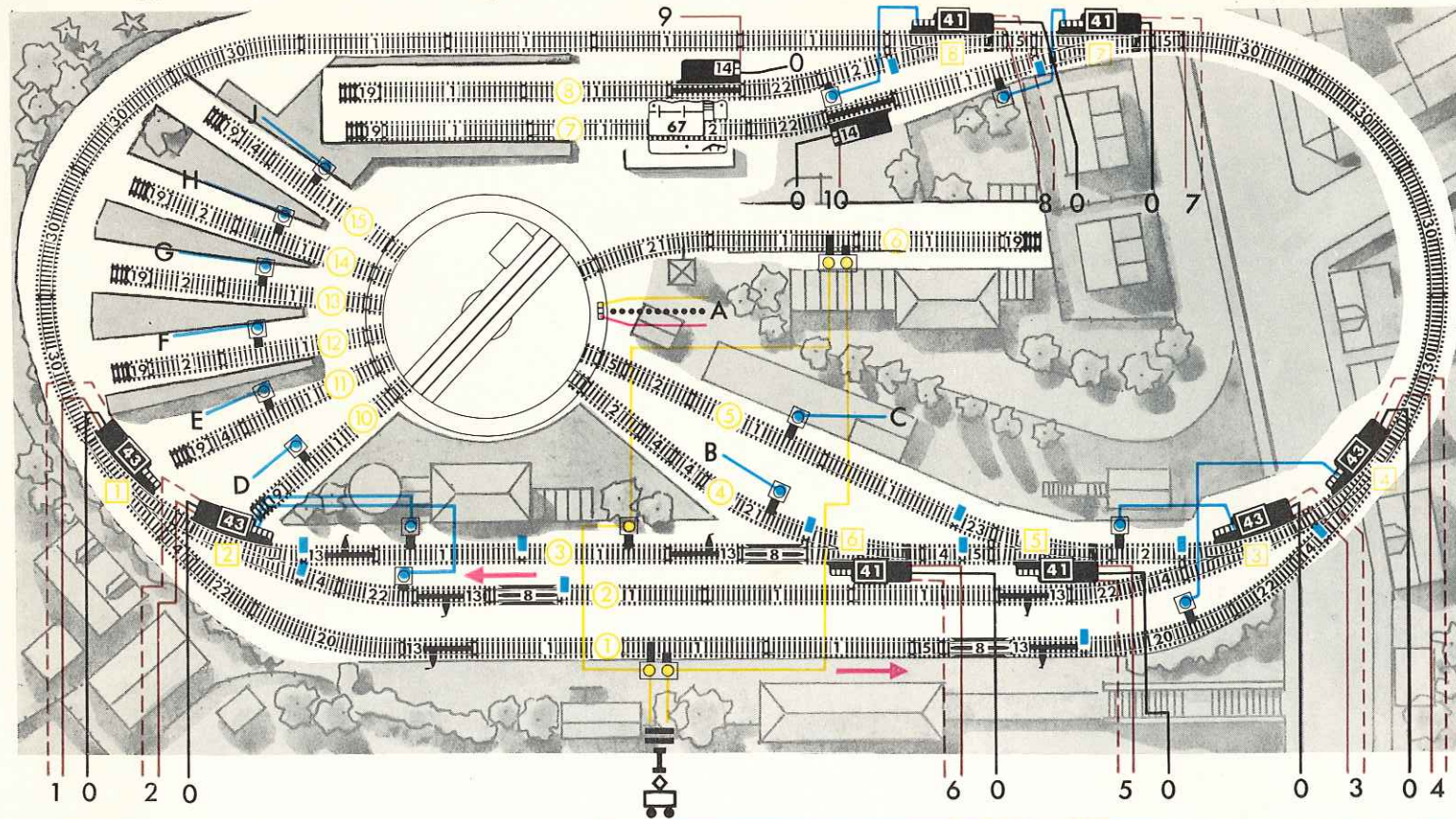

2,00m x 0,95m

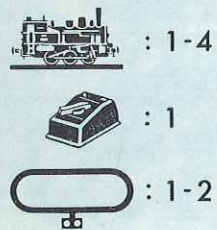

Symb. N°	1	2	4	5	8	13	14	19	20
Art. N°	..00	..00/2	..00/4	..00/5	..10	..00/2 E	..00/2 EM	..88	..01
	27x	8x	9x	5x	3x	6x	2x	9x	2x

Symb. N°	21	22	23	30	41	43	58			
Art. N°	..01/2	..01½	..01/3	..03	..24 A	..23 A	..80	60	62	78
	2x	6x	1x	8x	2 P.	2 P.	1x	1x	12x	15x

Symb. N°	67									
Art. N°	67	507	516	517	521	530	533	535	538	711 712
	1x	4x	4x	1x	1x	8x	10x	1x	36x	1x

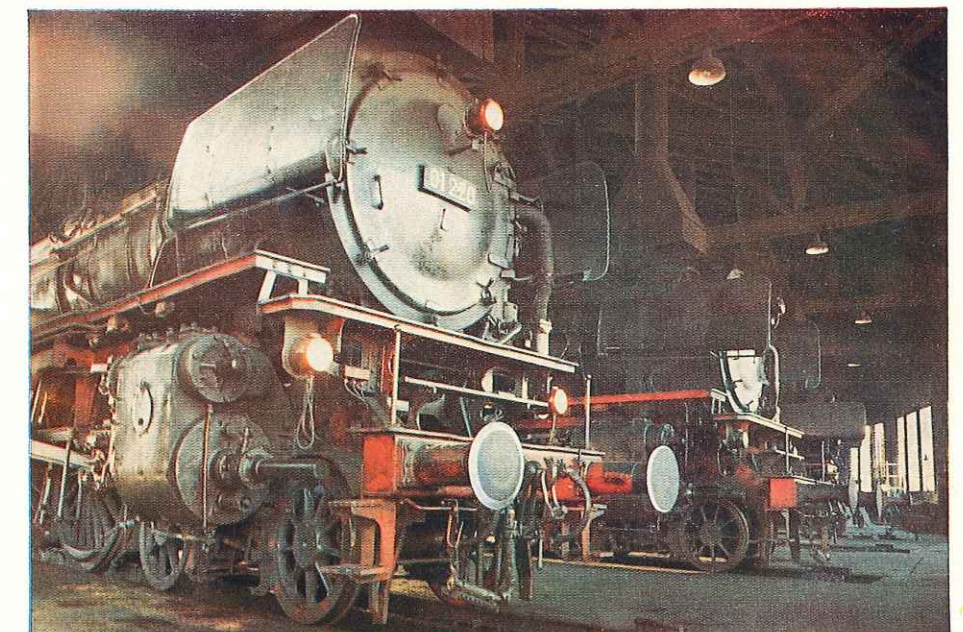
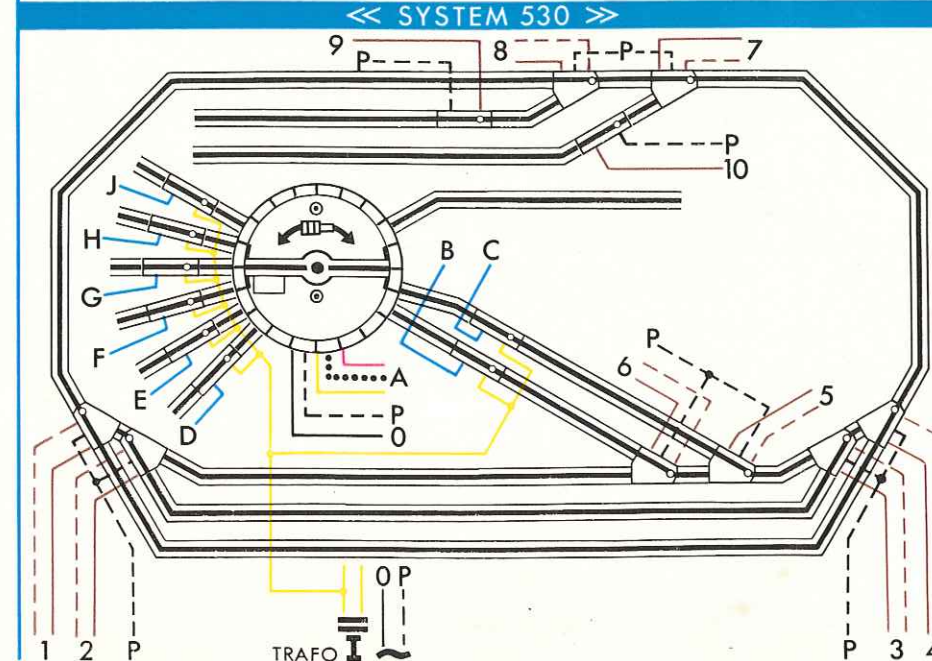
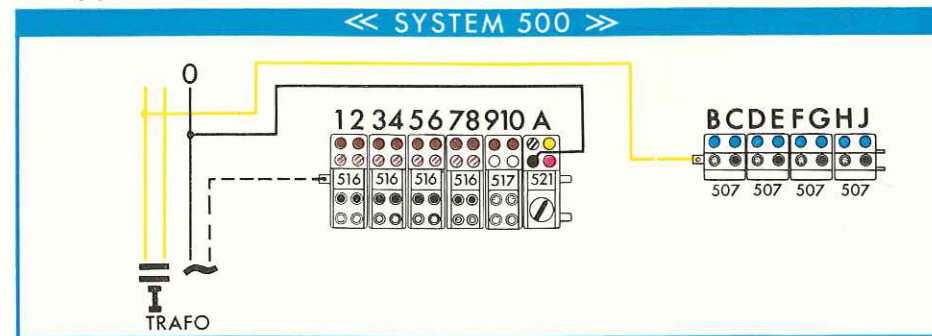

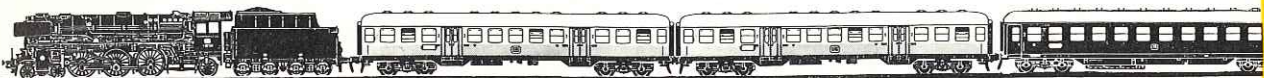

# FLEISCHMANN

international

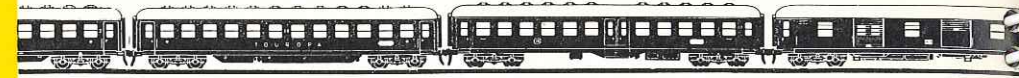

**M**  
4226  
PERFEKT

1,90m x 0,80m

: 1  
 : 1  
 : 1

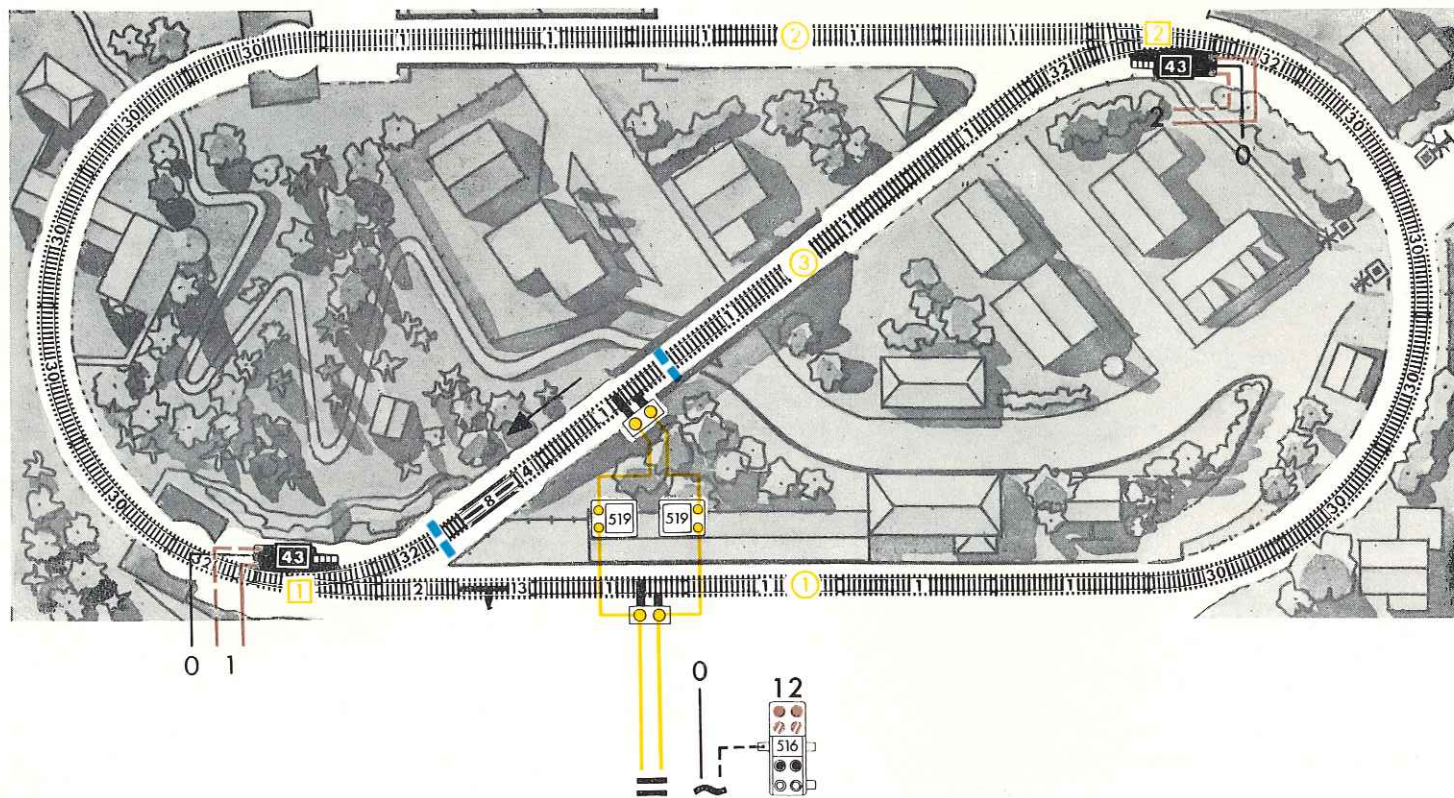

Symb. N°	1	2	4	8	13	30
Art. N°	..00	..00/2	..00/4	..10	..00/2 E	..03
	13x	1x	1x	1x	1x	10x

Symb. N°	32	43					<b>I</b>
Art. N°	..03½	..23 A	60	62	516	519	711 712
	4x	2x	2x	4x	1x	2x	1x

Symb. N°	1	2	5	8	13	20
Art. N°	..00	..00/2	..00/5	..10	..00/2 E	..01
	11x	2x	1x	1x	1x	2x

Symb. N°	30	41				<b>I</b>
Art. N°	..03	..24 A	60	62	516	711 712
	12x	2x	1x	8x	1x	1x

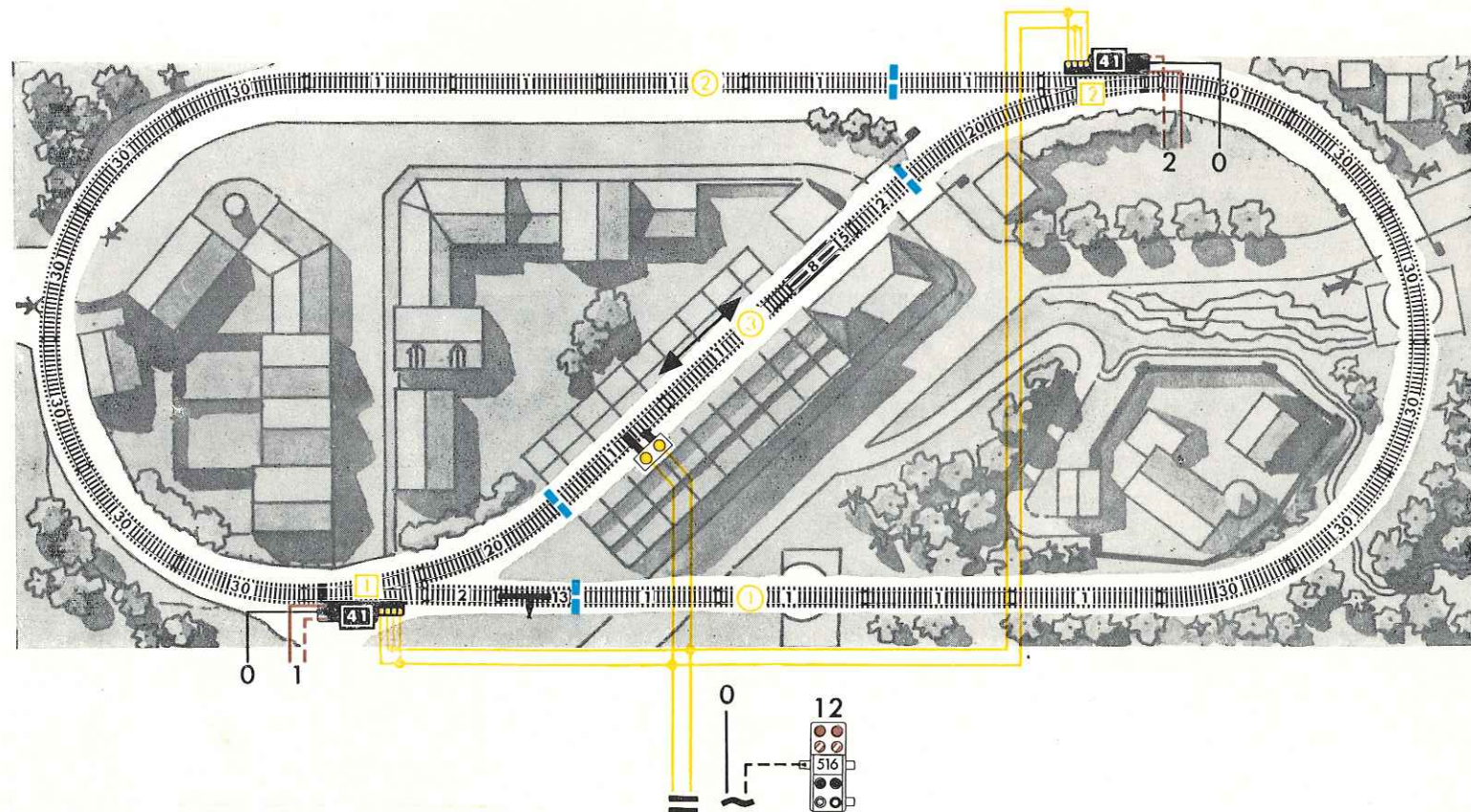

**M**  
4227  
PERFEKT

1,95m x 0,80m

: 1  
 : 1  
 : 1

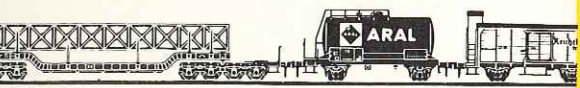

# FLEISCHMANN

international

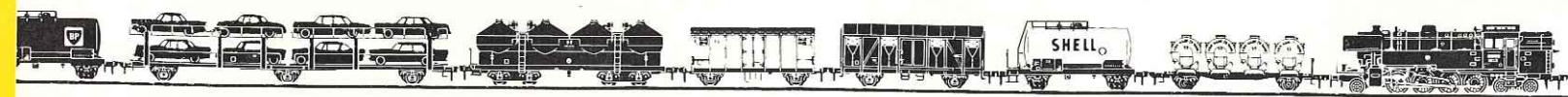

**M**  
4228  
PERFEKT

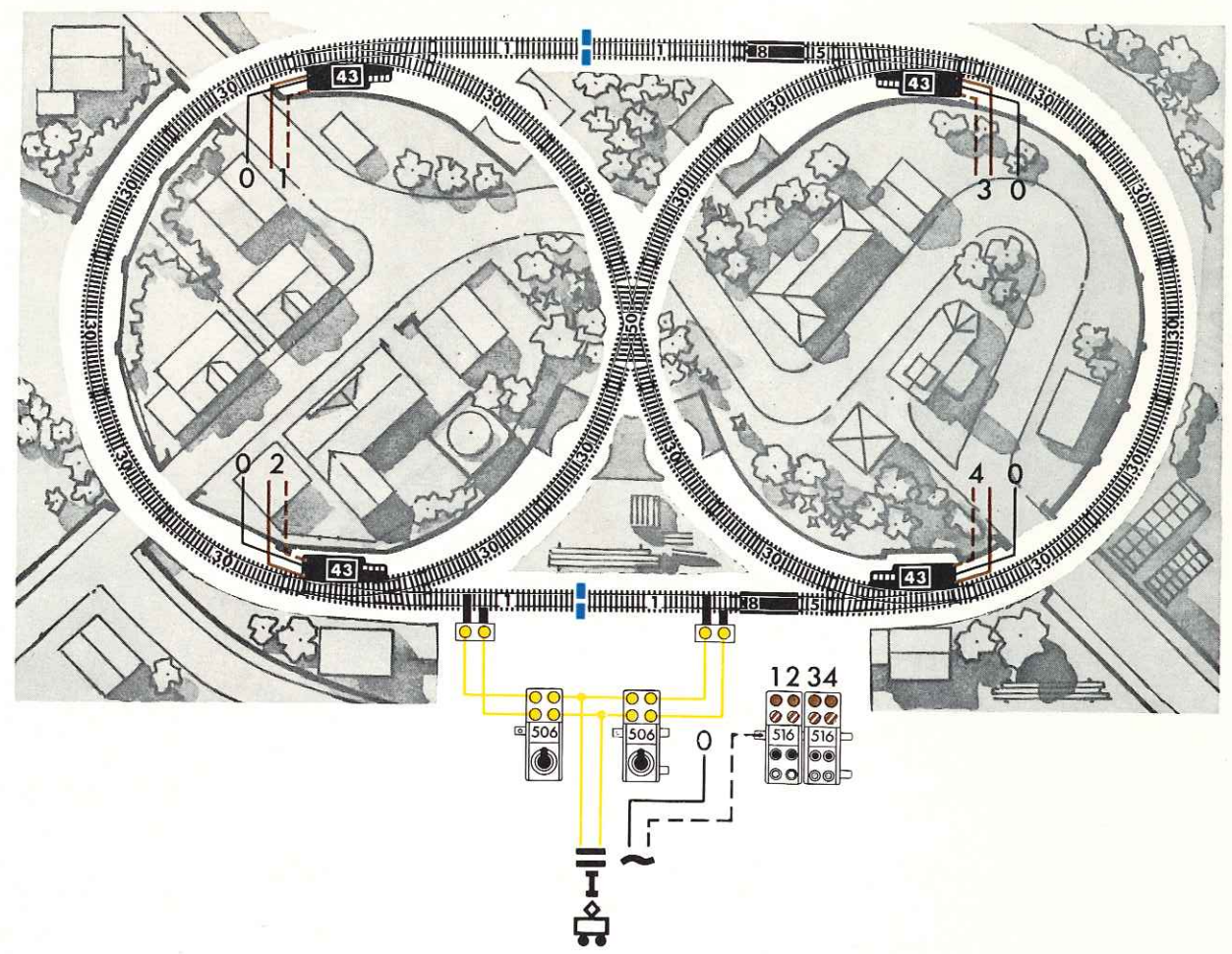

Symb. N°	1	5	8	30	43
Art. N°	..00	..00/5	..10	..03	..23 A
	4x	2x	2x	18x	2 P.

Symb. N°	50					
Art. N°	..12	60	62	506	516	711 712
	1x	2x	4x	2x	2x	1x

1,55 m x 0,80 m

: 1  
 : 1  
 : 1

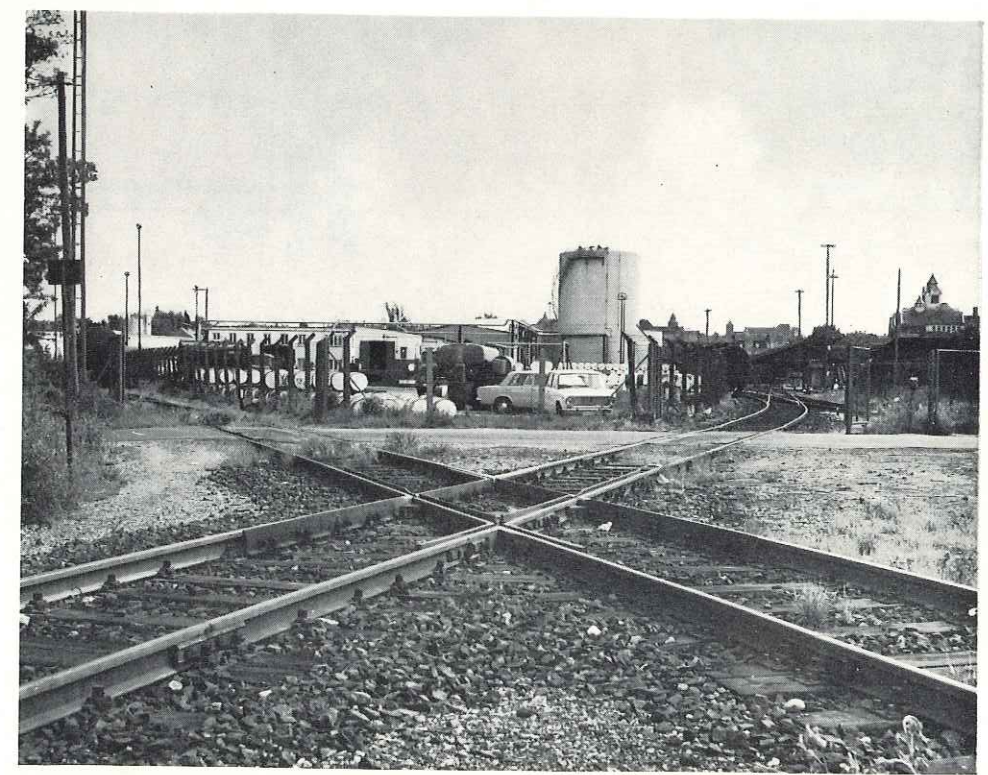



## M

### 4229a

PERFEKT

1,90m x 0,80m

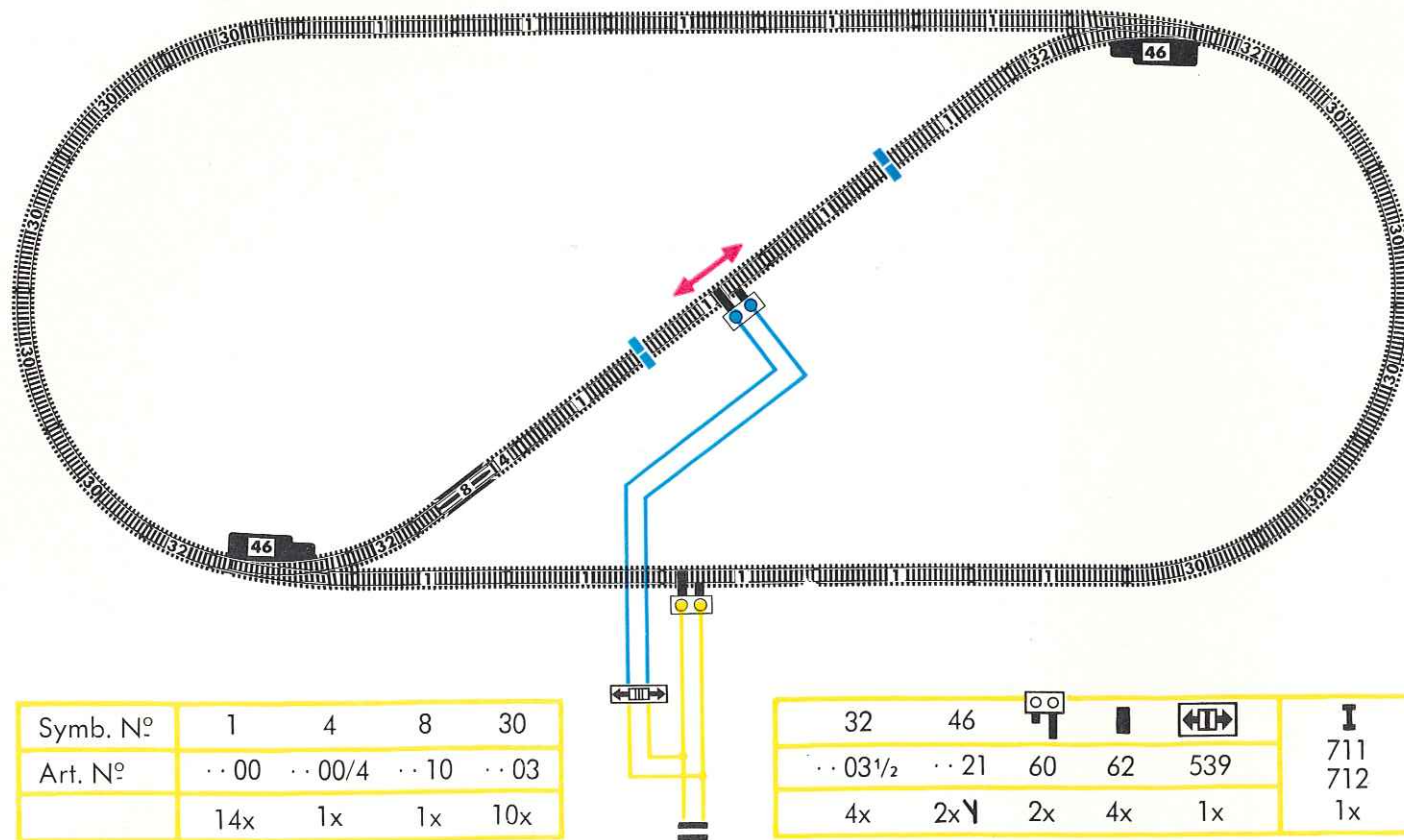
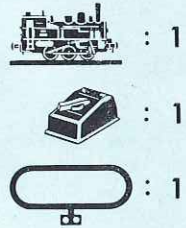

## M

### 4229c

PERFEKT

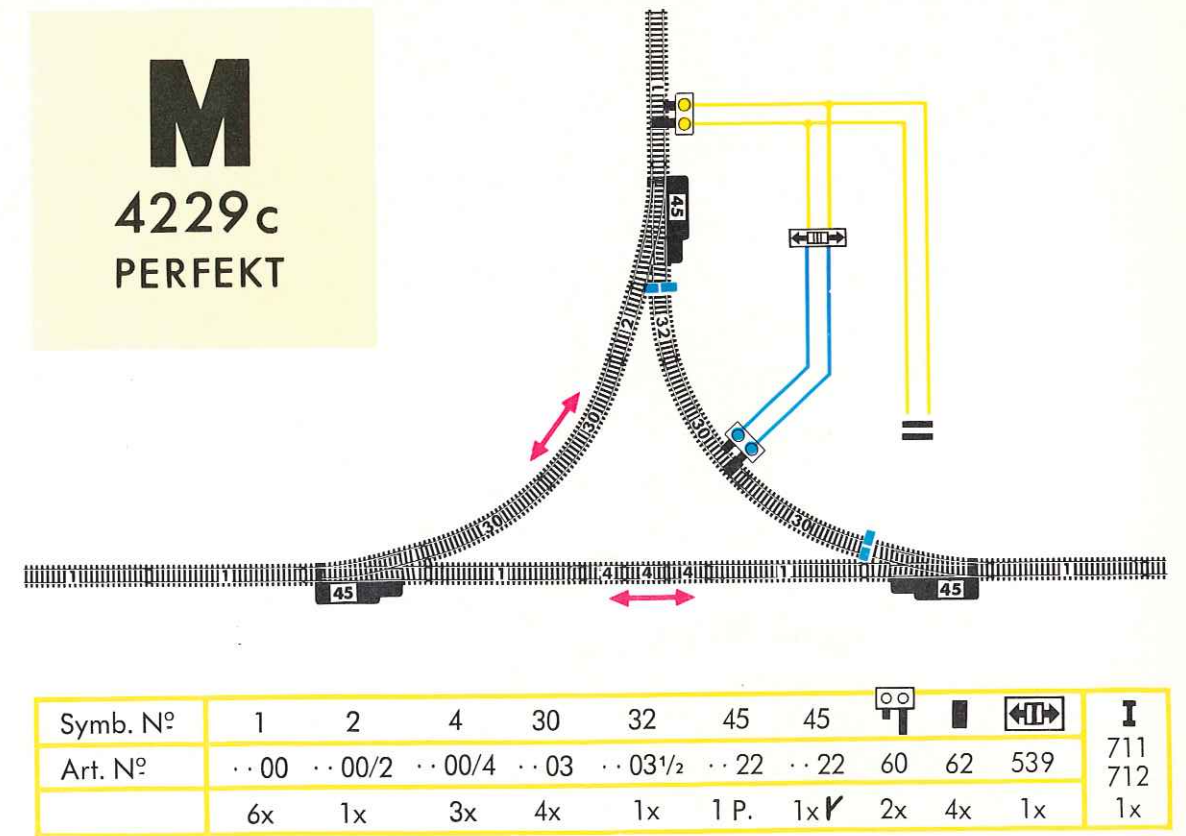

## M

### 4229b

PERFEKT

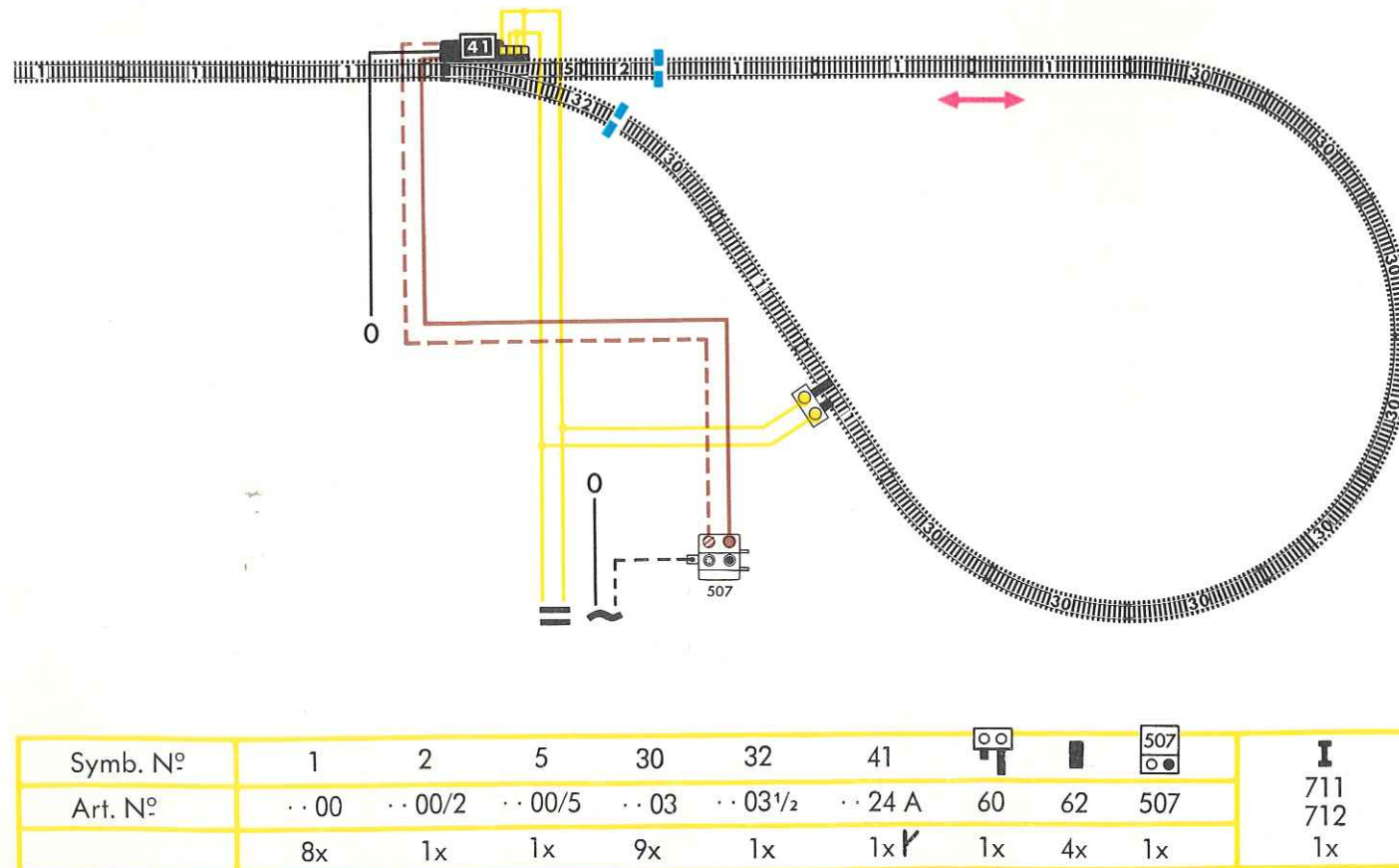

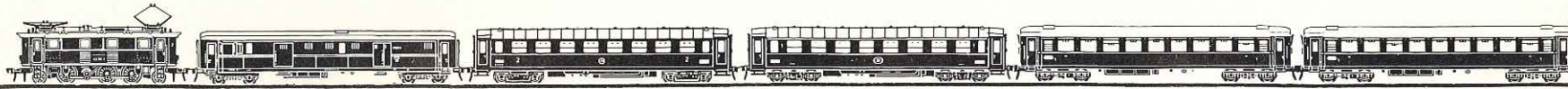

# FLEISCHMANN

international

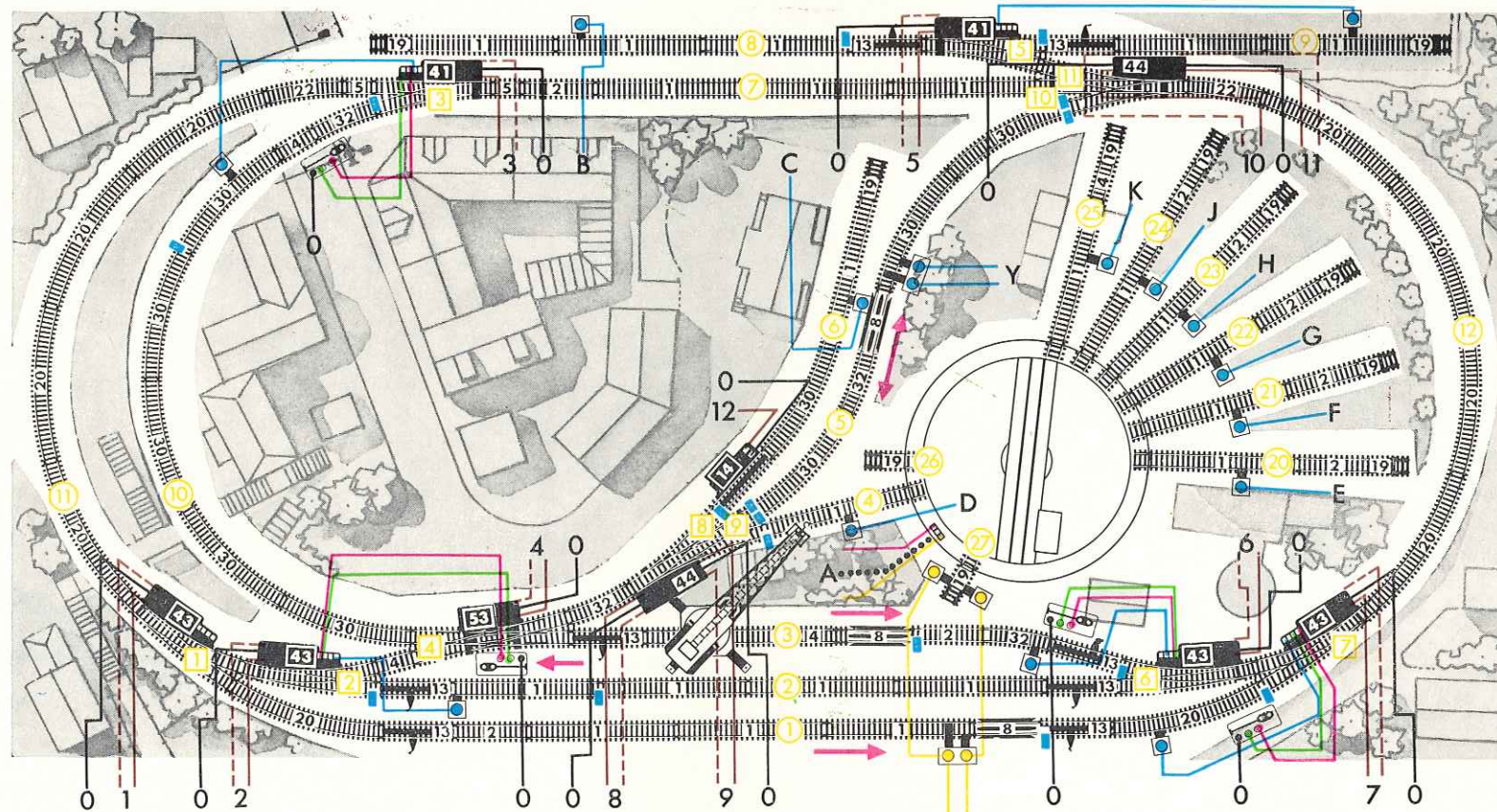
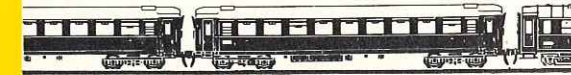

**M**  
4230  
PERFEKT

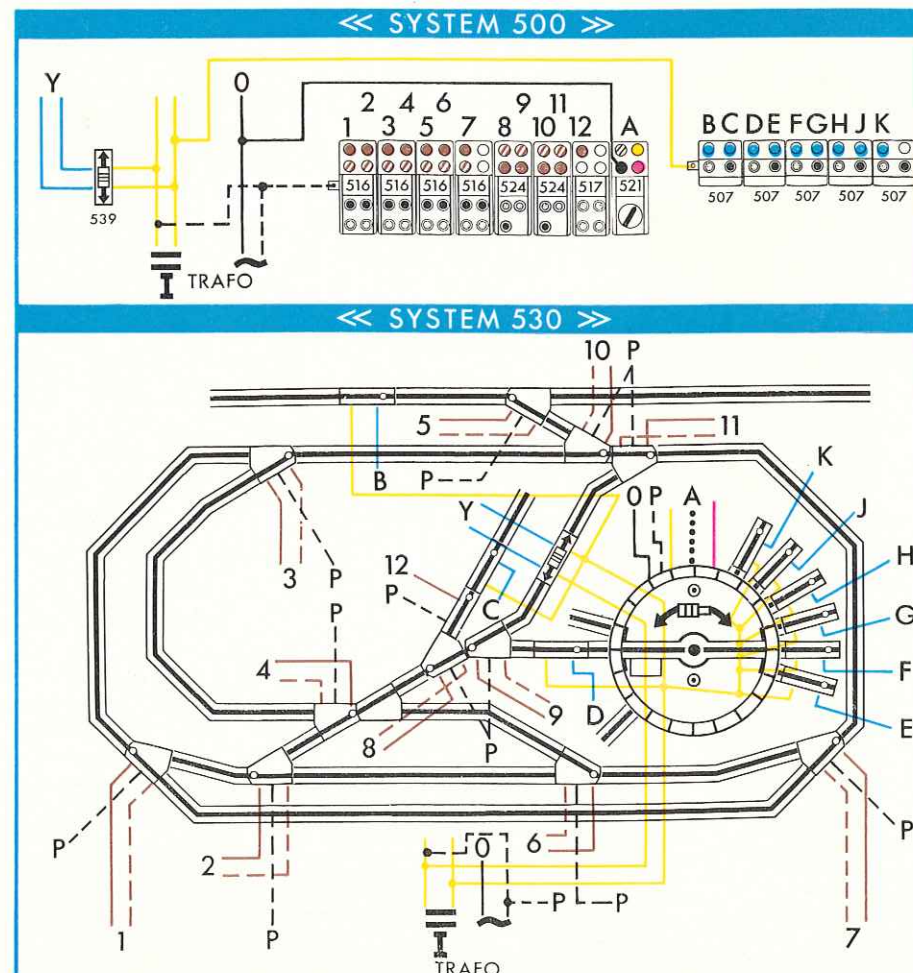

2,05 m x 1,05 m

- : 1-4
- : 1
- : 1

Symb. N°	1	2	4	5	8	13	14	19	20	22
Art. N°	· · 00 · · 00/2 · · 00/4 · · 00/5 · · 10 · · 00/2 E · · 00/2 EM · · 88 · · 01 · · 01 1/2									
	23x	8x	4x	2x	3x	8x	1x	11x	10x	2x

Symb. N°	30	32	41	43	44	53	58								
Art. N°	· · 03 · · 03 1/2 · · 24 A · · 23 A · · 26 A · · 25 A · · 80	60	62	78	539	507									
	9x	4x	1 P.	2 P.	2x	1x	1x	2x	16x	16x	1x	5x			

Symb. N°														
Art. N°	516	517	521	524	1771	530	533	535	536	538	539	712		
	4x	1x	1x	2x	4x	11x	10x	1x	1x	37x	1x	1x		

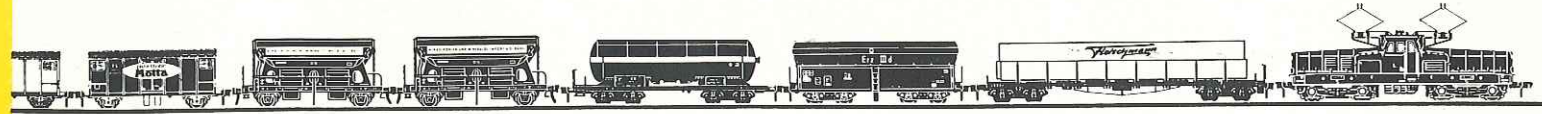
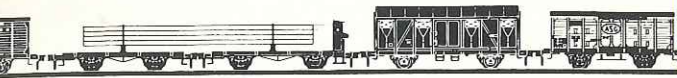

# M

## 4231

PERFEKT

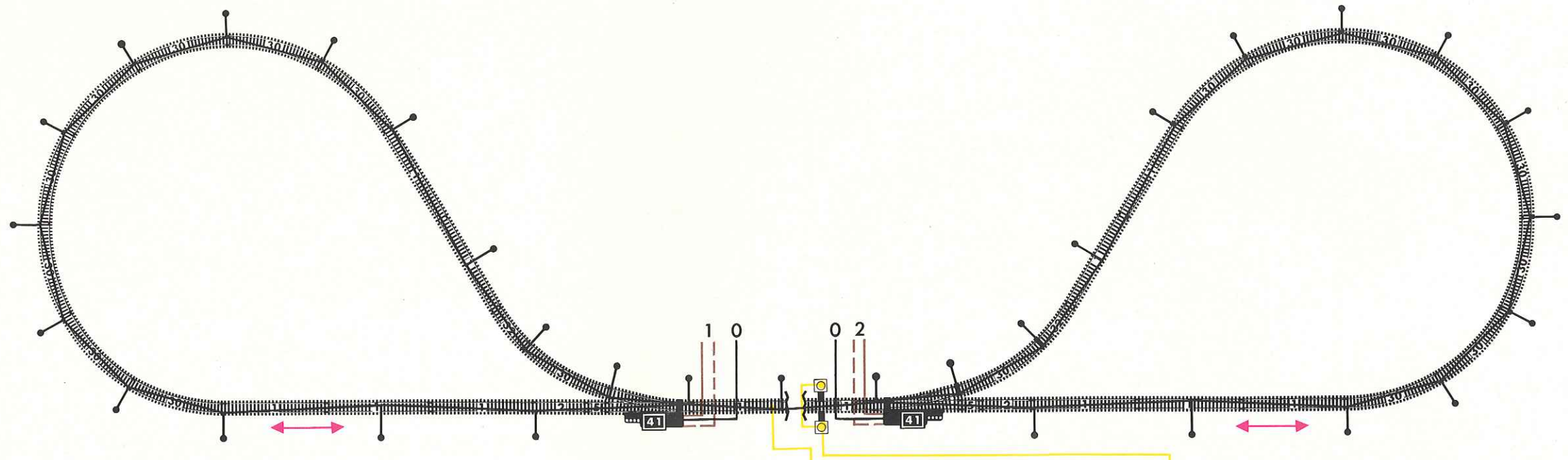

2.90m x 0.80m

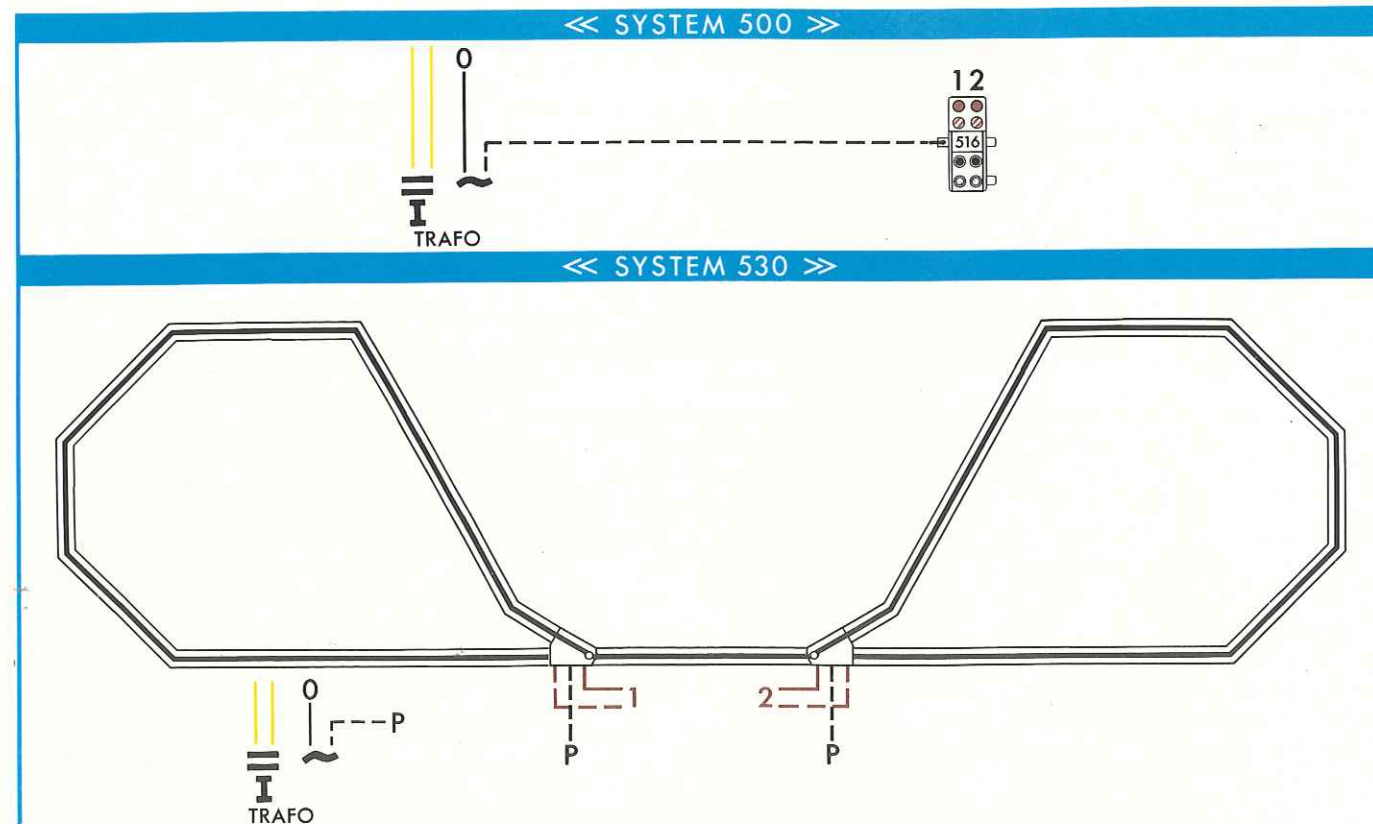

Symb. N°	1	2	5	30	32	41					<b>I</b>
Art. N°	..00	..00/2	..00/5	..03	..03½	..24 A	78	516	530	538	711 712
	12x	2x	2x	18x	2x	1 P.	2x	1x	2x	22x	1x

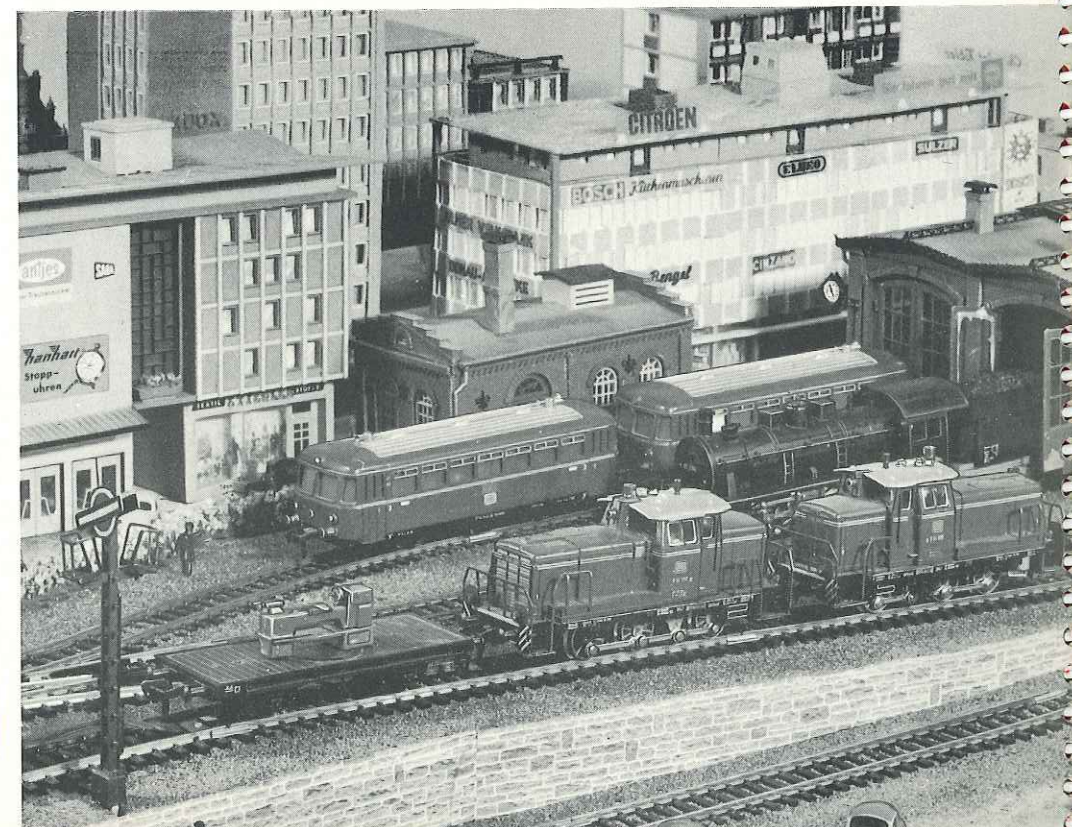



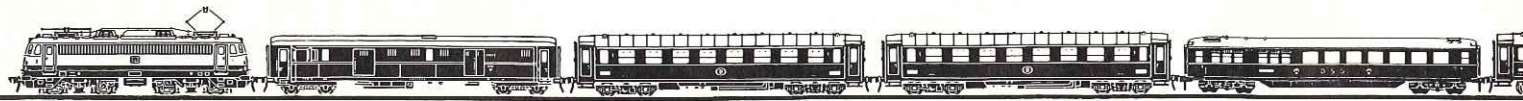

**FLEISCHMANN**  
international

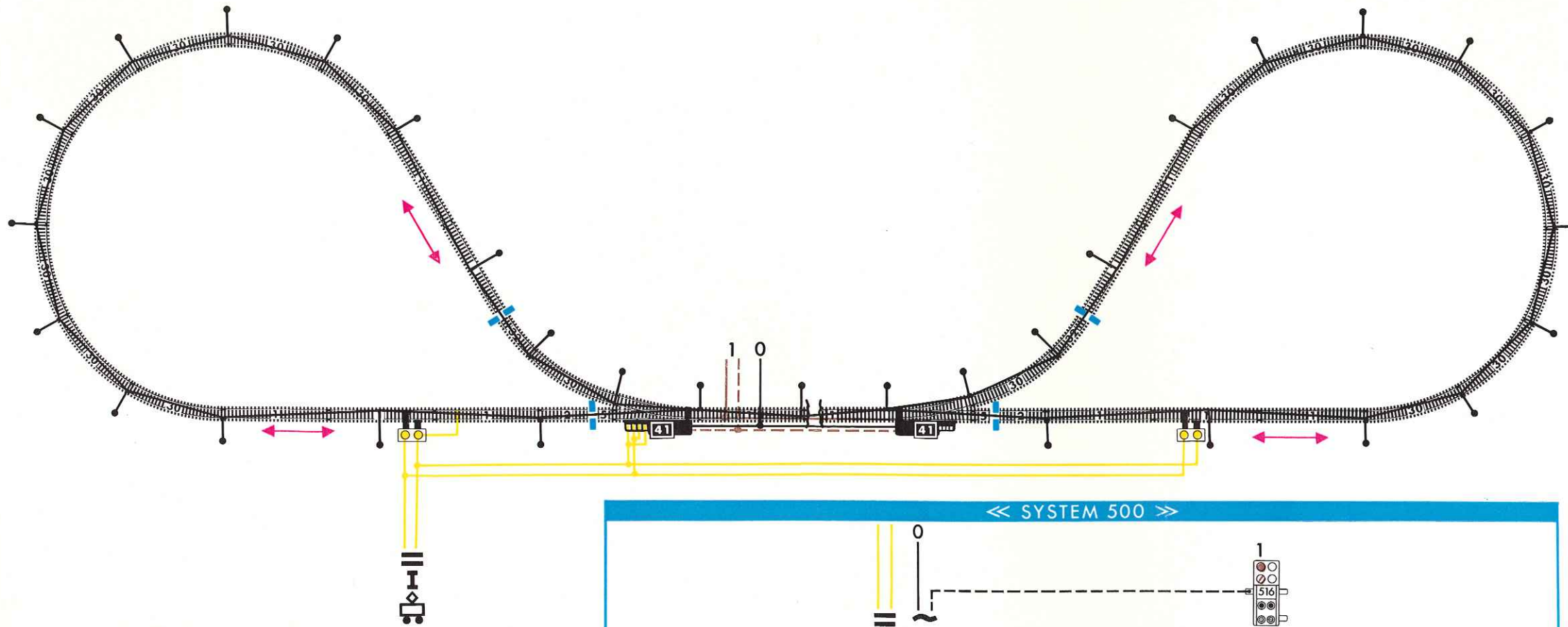
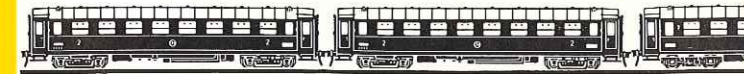

**M**

4232

PERFEKT

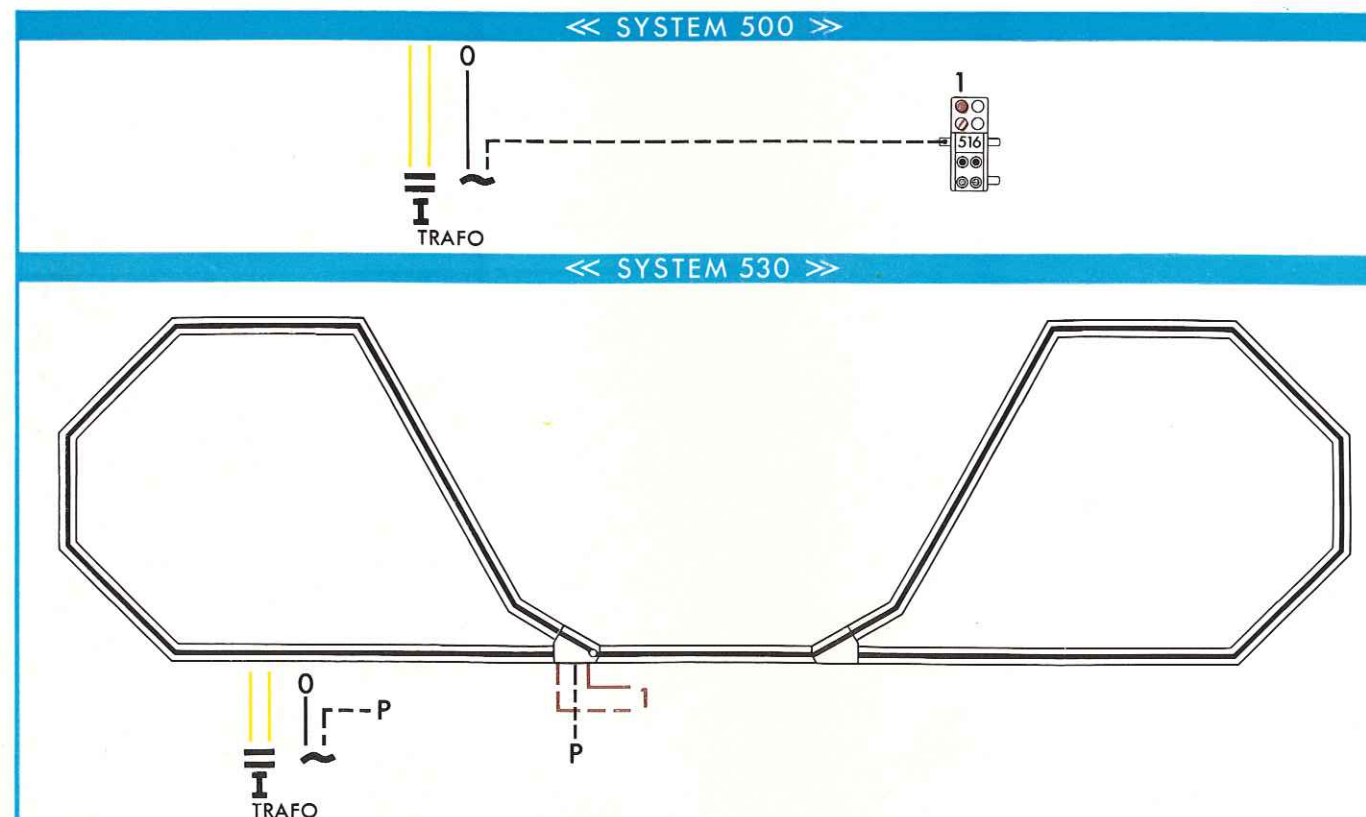

2,90 m x 0,80 m

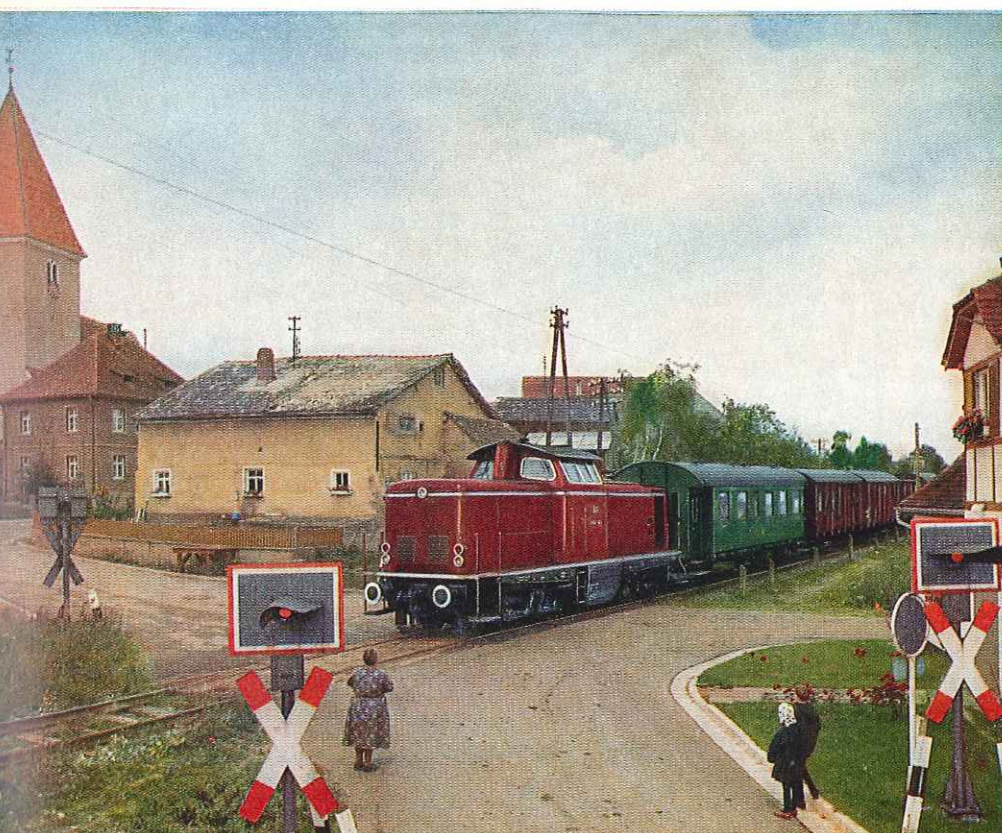

Symb. N°	1	2	5	30	32	41						
Art. N°	..00	..00/2	..00/5	..03	..03½	..24 A	516	60	62	530	536	538
	12x	2x	2x	18x	2x	1 P.	1x	2x	8x	1x	1x	22x

# M

## 4233

2,35 m x 1,25 m



: 1



: 1



: 1

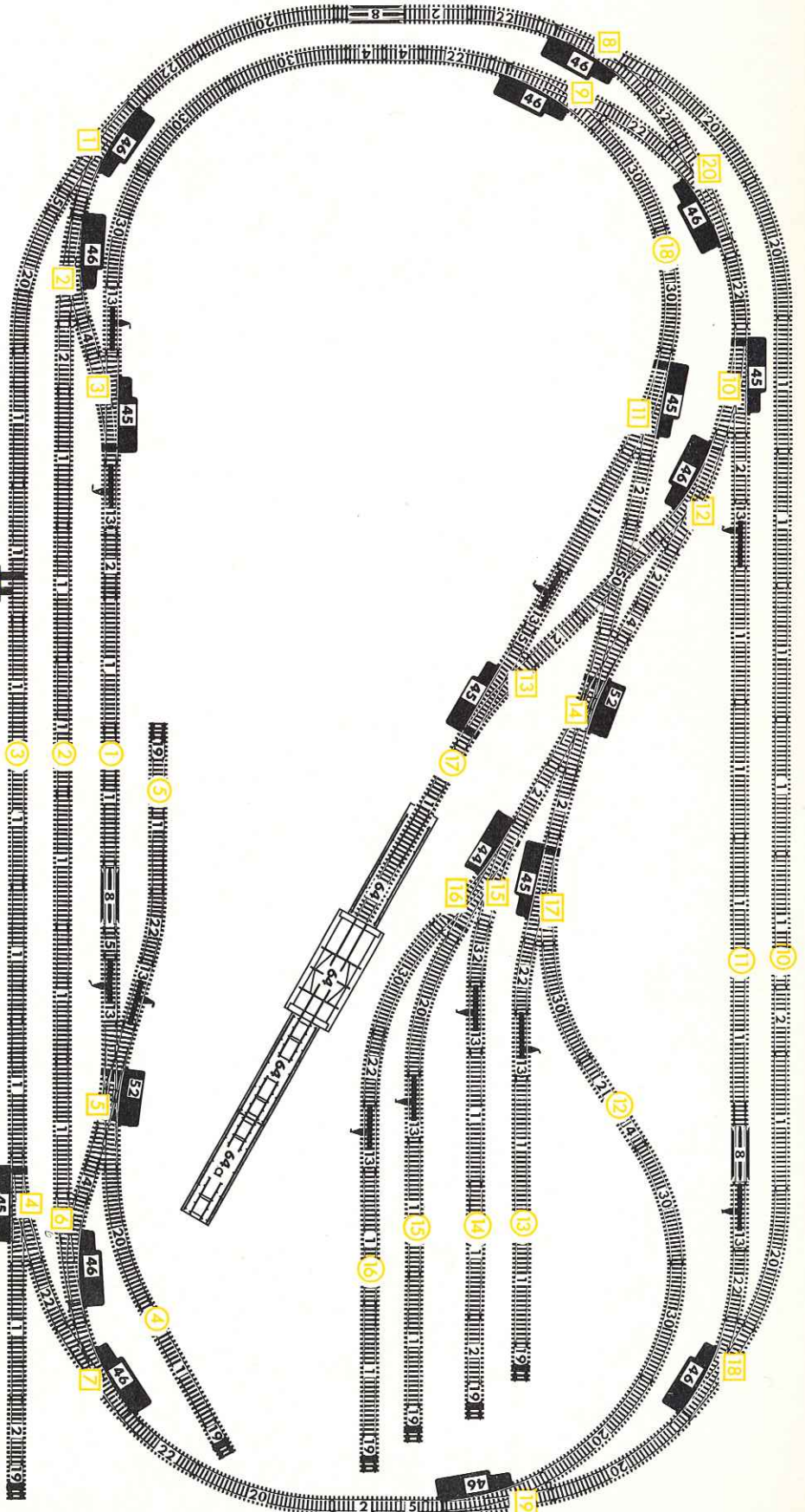
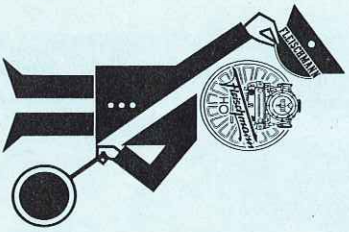

Symb. N°	1	2	4	5	8	13
Art. N°	..00	..00/2	..00/4	..00/5	..10	..00/2/E
	37x	14x	6x	4x	3x	11x

	19	20	22	30	32	44	45	46	50	52	I	64	64a
	..88	..01	..01 1/2	..03	..03 1/2	..26 A	..22	..21	..12	..25	60	64	64a
	7x	10x	11x	9x	2x	1x	3 P.	5 P.	1x	2x	1x	1x	1x
												711	712
												1x	1x

# M

## 4234

### PERFEKT

2,35 m x 1,25 m



: 1-4



: 1-2



: 1-2

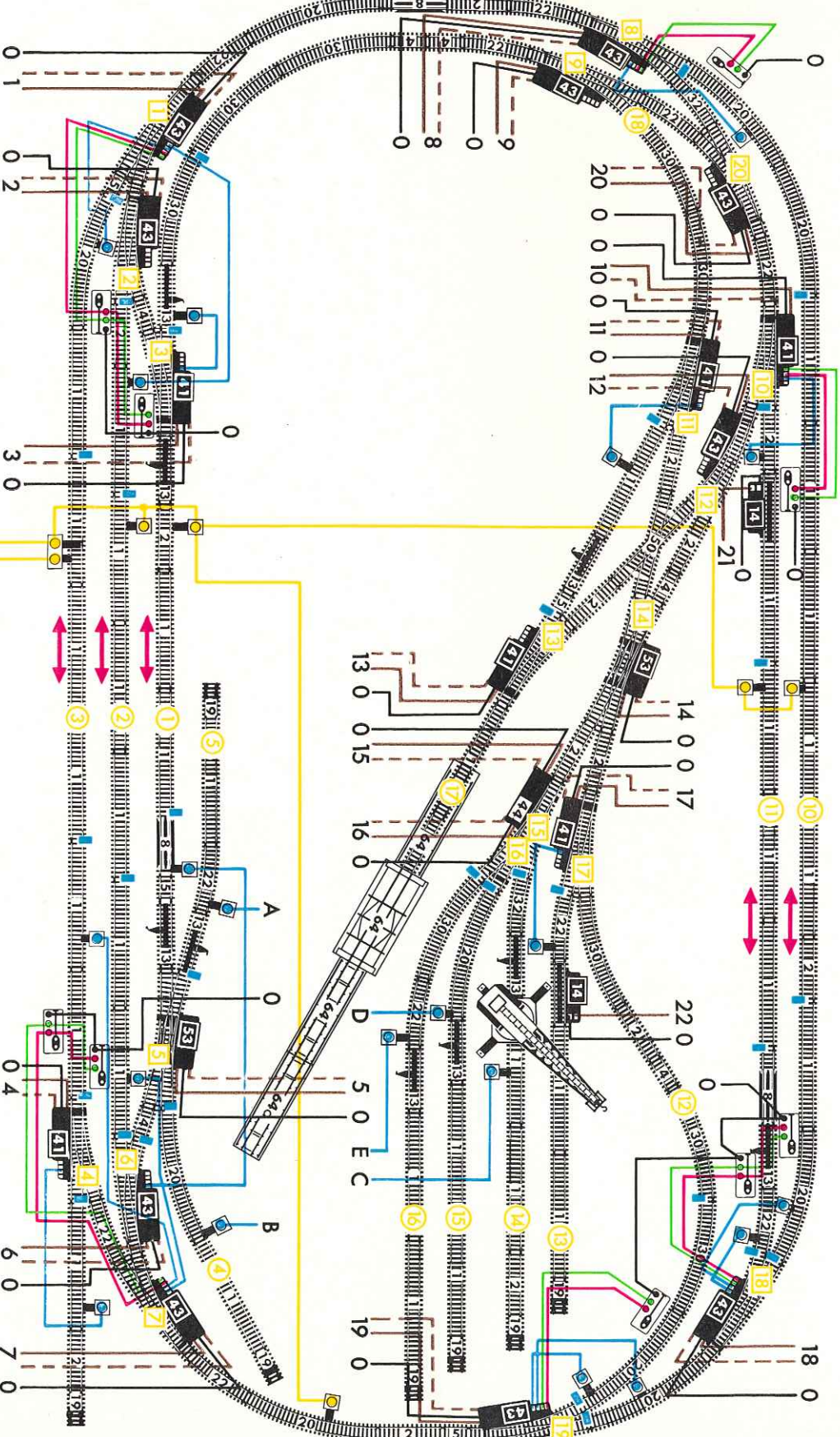

<< SYSTEM 500 >>

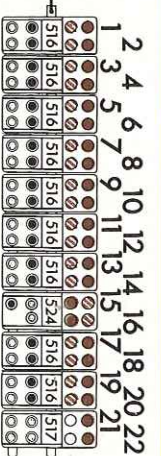

>> SYSTEM 530 >>



# FLEISCHMANN

## International

Symb. N°	1	2	4	5	8	13	14	19	20
Art. N°	..00	..00/2	..00/4	..00/5	..10	..00/2/E	..00/2/EM	..88	..01
	37x	14x	6x	4x	3x	9x	2x	7x	10x

Symb. N°	22	30	32	41	43	44	50	53	I
Art. N°	..01 1/2	..03	..03 1/2	..24 A	..23 A	..26 A	..12	..25 A	60
	11x	9x	2x	3 P.	5 P.	1x	1x	2x	1x
									32x

Symb. N°	507	516	517	524	8	I	I	I	I
Art. N°	78	507	516	517	524	1771	530	536	537
	24x	3x	9x	1x	1x	9x	20x	7x	2x
									1x
									54x

Symb. N°	711	712
Art. N°	711	712
	1x	1x

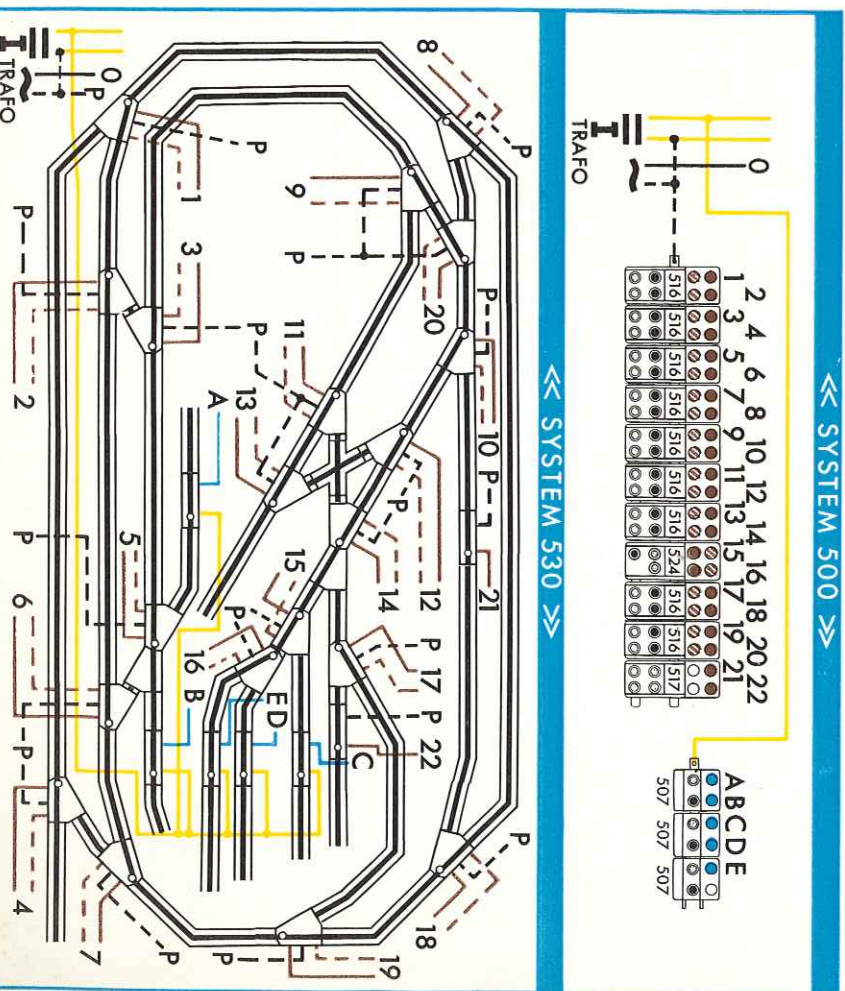



# FLEISCHMANN

international

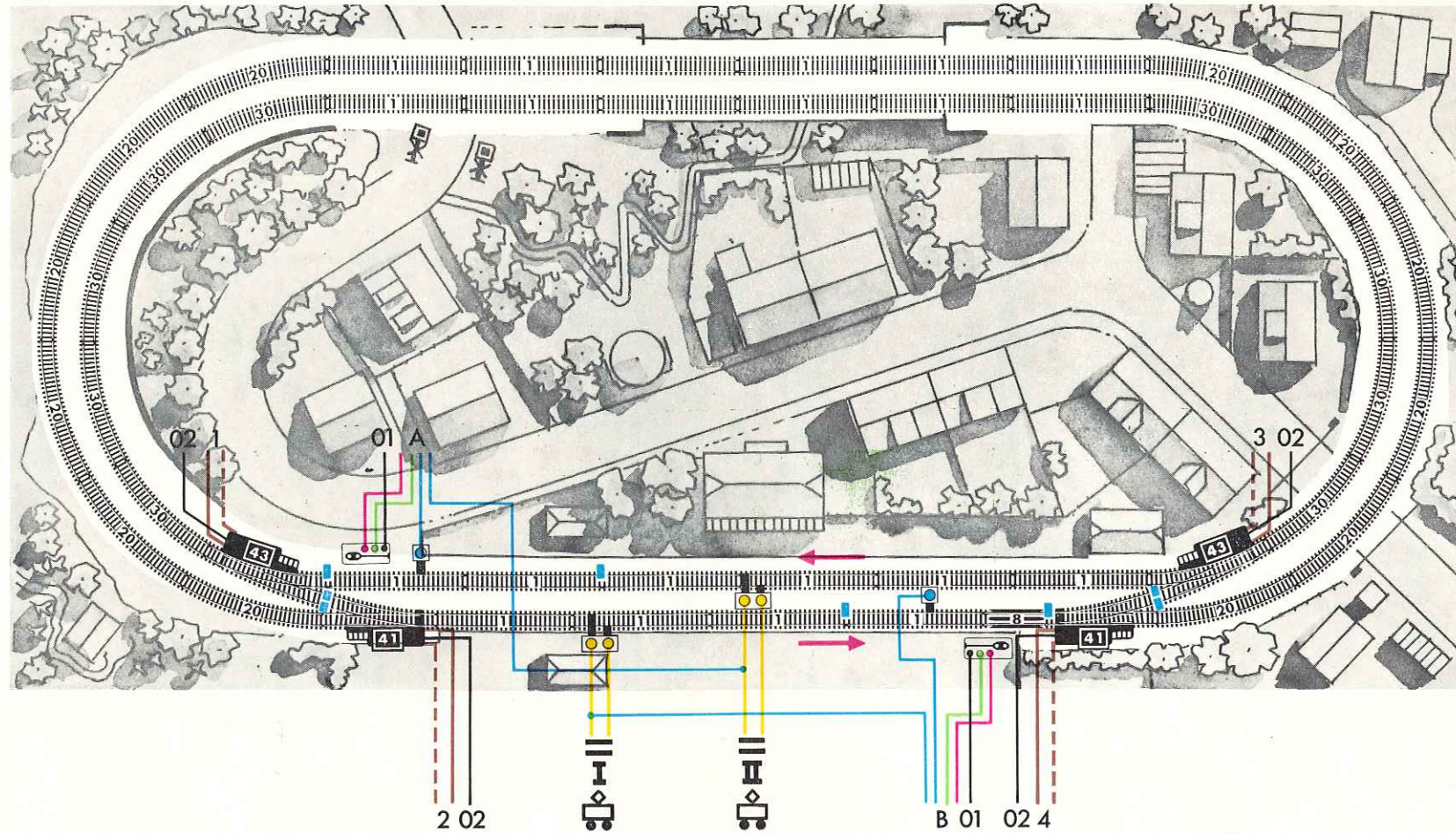



# M



## 4235





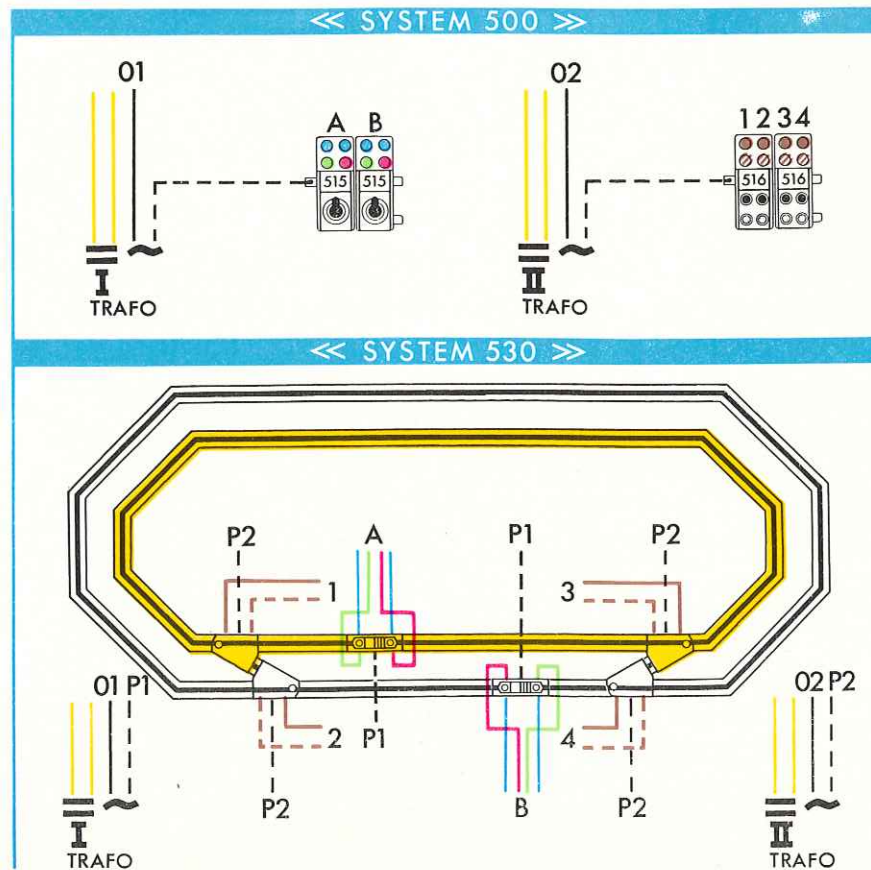



### PERFEKT

2,15m x 0,90m

-  : 1-2
-  : 1-2
-  : 1-2



Symb. N°	1	8	20	30	41	43		
Art. N°	..00	..10	..01	..03	..24 A	..23 A	60	62
	22x	1x	12x	10x	1 P.	1 P.	2x	8x

Symb. N°								
Art. N°	78	515	516	1771	530	532	538	711 711 712 712
	2x	2x	2x	2x	4x	2x	29x	1x 1x

**M**  
4236

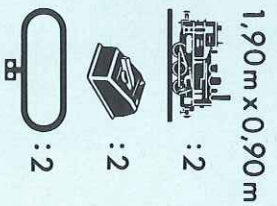

**FLEISCHMANN**  
International

Symb. N°	1	20	30		
Art. N°	..00	..01	..03	711	711
	20x	12x	12x	712	712
				1x	1x

**M**  
4237  
PERFEKT

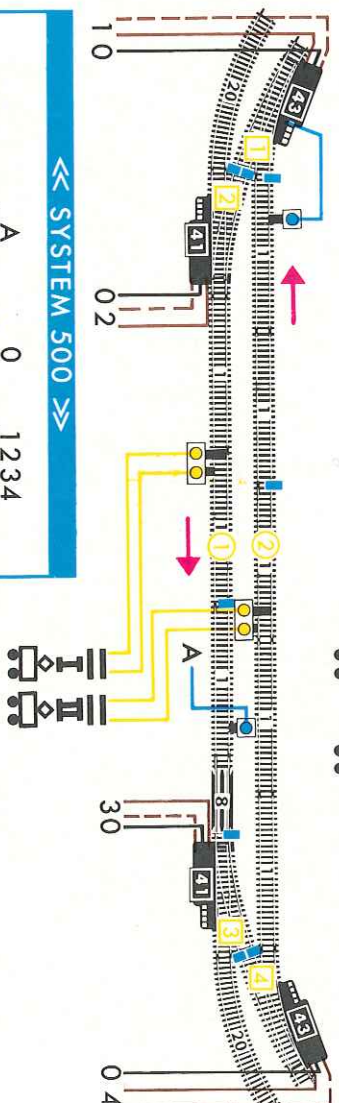
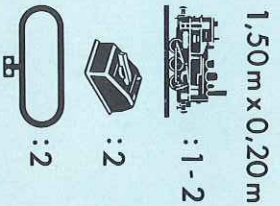

Symb. N°	1	8	20	41	43	
Art. N°	..00	..10	..01	..24 A	..23 A	60
		8x	1x	2x	1 P.	1 P.
						2x

Symb. N°								
Art. N°	62	78	516	518	530	531	711	711
	8x	2x	2x	1x	4x	1x	712	712
							1x	1x

**M**  
4238  
PERFEKT

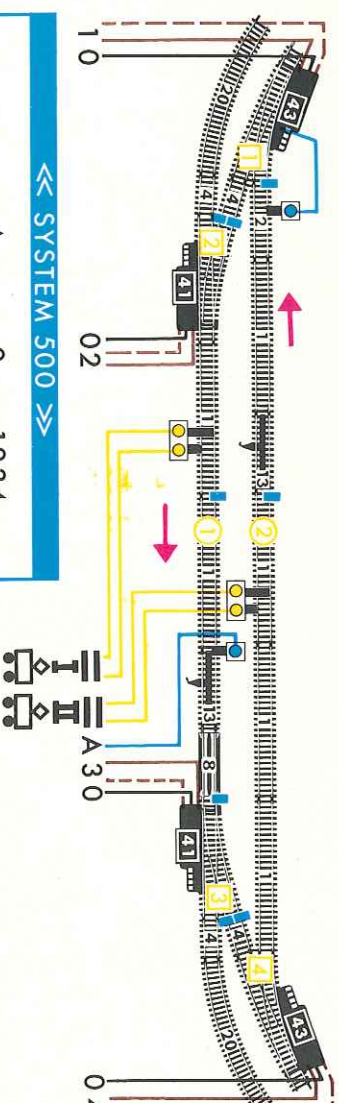
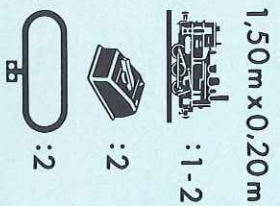

Symb. N°	1	2	4	8	13	41	43
Art. N°	..00	..00/2	..00/4	..10	..01/2 E	..24 A	..23 A
	6x	1x	4x	1x	2x	1 P.	1 P.

Symb. N°							
Art. N°	60	62	78	516	518	530	531
	2x	8x	2x	2x	1x	4x	1x
							711
							711
							712
							712
							1x
							1x

**M**  
4239  
PERFEKT

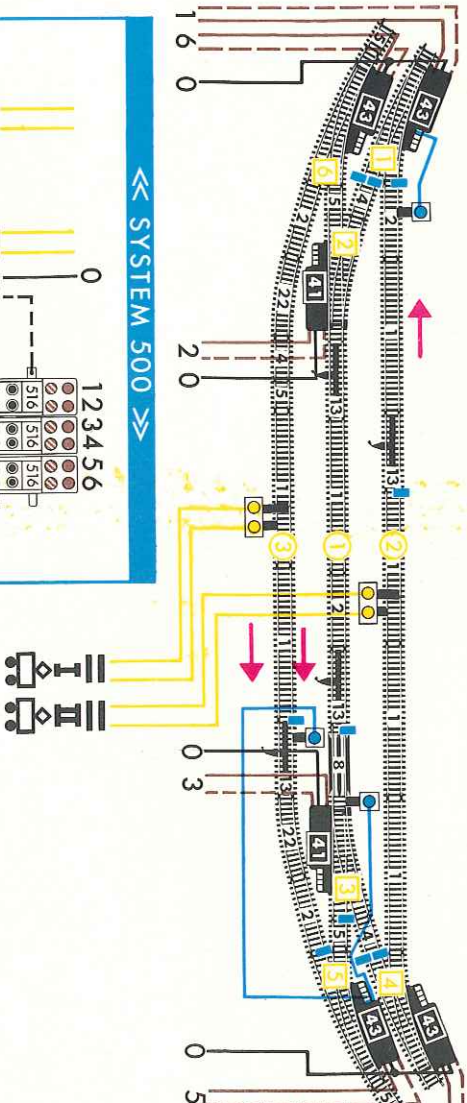
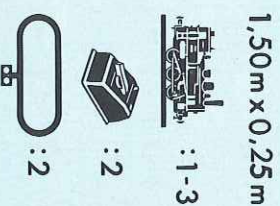

Symb. N°	1	2	4	5	8	13	22
Art. N°	..00	..00/2	..00/4	..00/5	..10	..00/2 E	..01 1/2
	7x	4x	3x	5x	1x	4x	2x

Symb. N°	41	43						
Art. N°	..24 A	..23 A	60	62	78	516	530	538
	1 P.	2 P.	2x	10x	3x	6x	10x	1x
							711	711
							712	712
							1x	1x

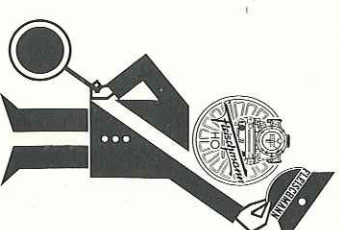

# M 4240

1,80 m x 0,40 m

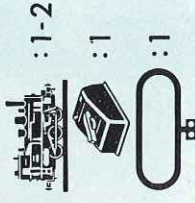

# M 4241

PERFEKT

1,80 m x 0,40 m

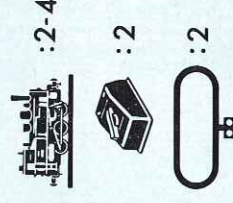

# M 4242

1,80 m x 0,45 m

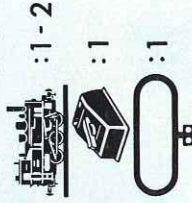

# M 4243

PERFEKT

1,80 m x 0,45 m

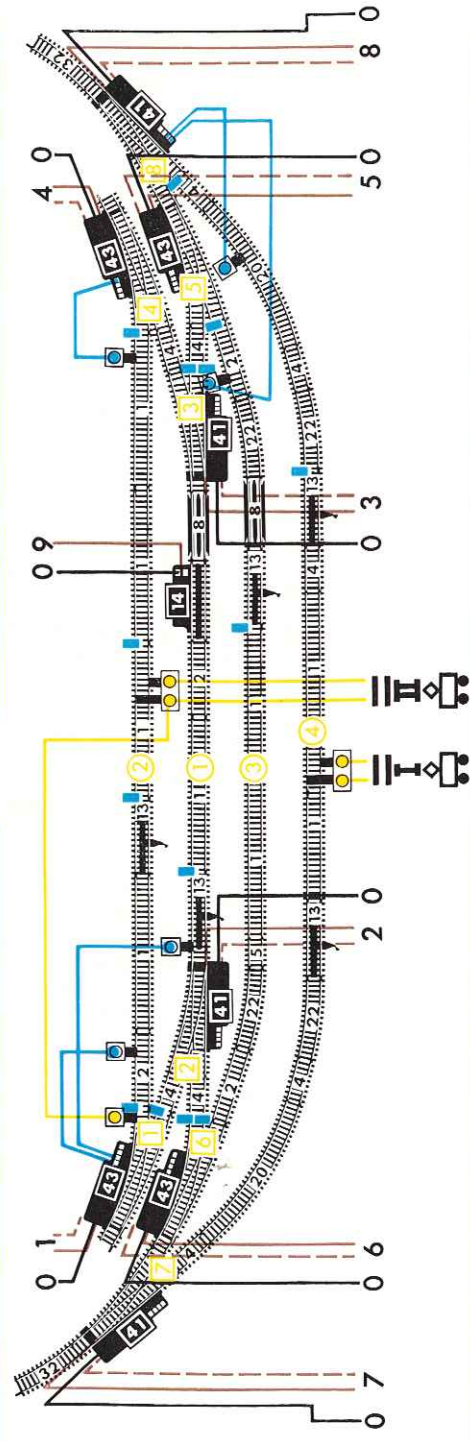
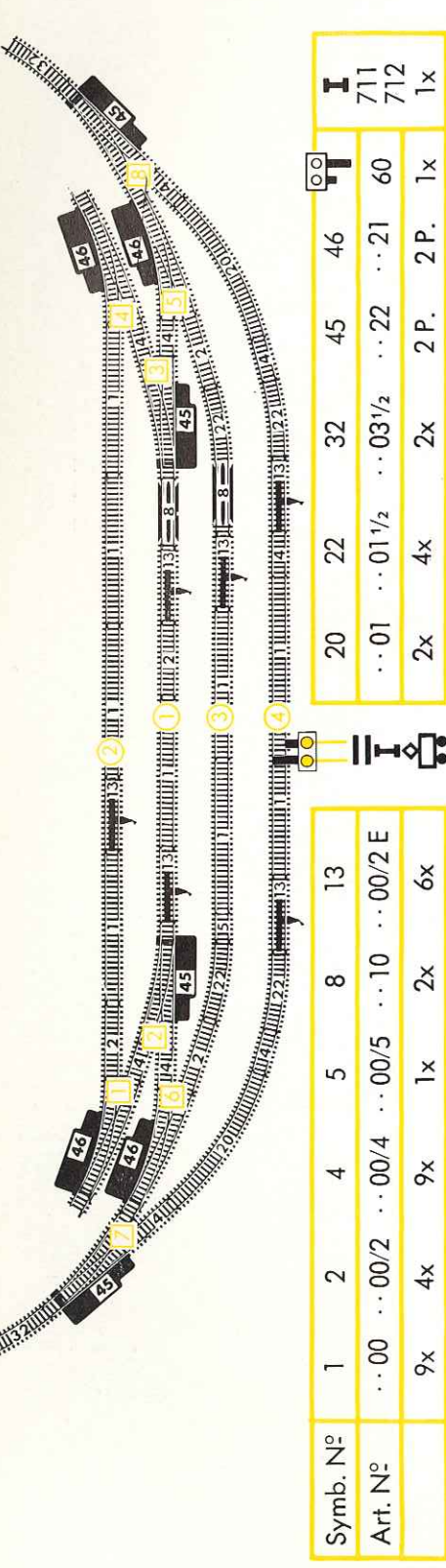
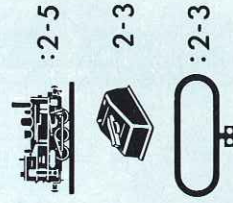

Symb. N°	1	2	4	5	8	13
Art. N°	..00	..00/2	..00/4	..00/5	..10	..00/2 E
	9x	4x	9x	1x	2x	5x

Symb. N°	14	20	22	32	41	43
Art. N°	..00/2 EM	..01	..01 1/2	..03 1/2	..24 A	..23 A
	1x	2x	4x	2x	2 P.	2 P.

Symb. N°						
Art. N°	60	62	78	516	517	530 533 538
	2x	14x	6x	4x	1x	8x 1x 15x

Symb. N°						
Art. N°	711	712	712	712	712	712
	1x	1x	1x	1x	1x	1x

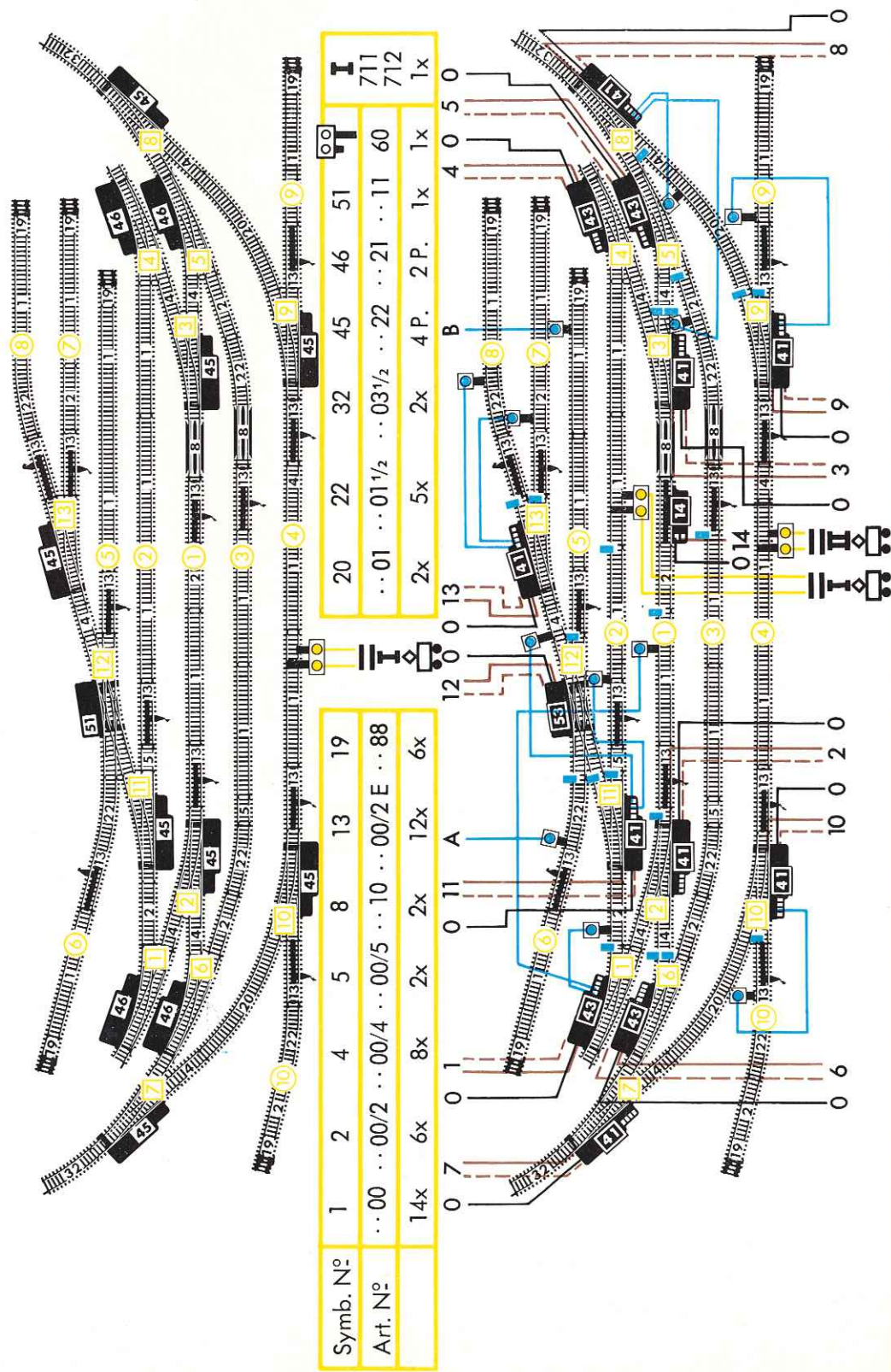
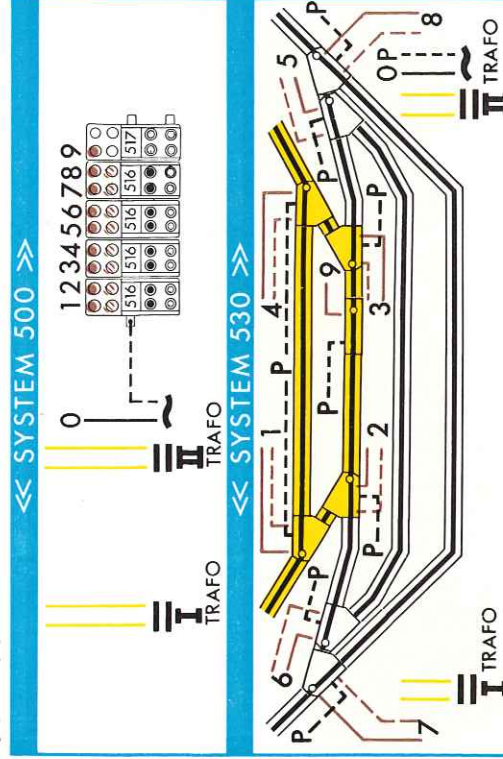

Symb. N°	1	2	4	5	8	13	14
Art. N°	..00	..00/2	..00/4	..00/5	..10	..00/2 E	..00/2 EM
	14x	6x	8x	2x	2x	11x	1x

Symb. N°	19	20	22	32	41	43	53
Art. N°	..88	..01	..01 1/2	..03 1/2	..24 A	..23 A	..25 A
	6x	2x	5x	2x	4 P.	2 P.	1x

Symb. N°						
Art. N°	60	62	78	507	516	517 530 533 538
	2x	20x	12x	1x	7x	1x 13x 3x 1x 22x

Symb. N°						
Art. N°	711	711	712	712	712	712
	1x	1x	1x	1x	1x	1x

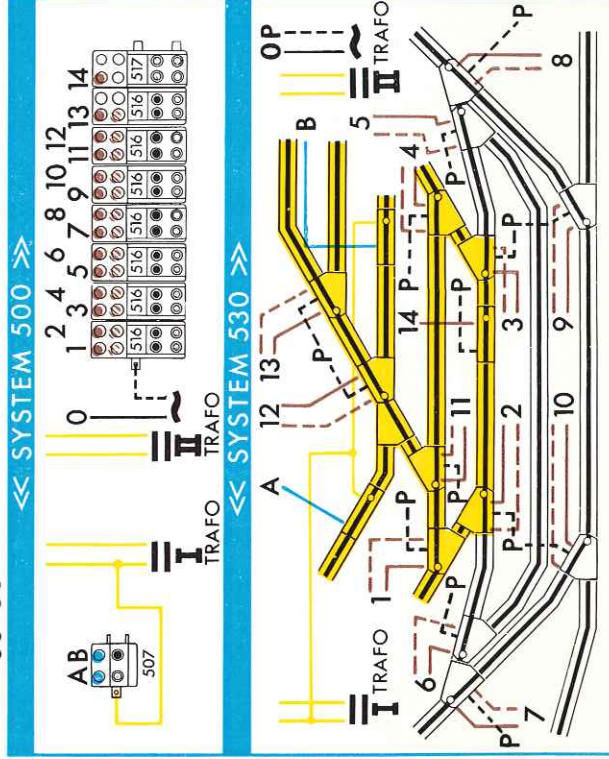



# FLEISCHMANN

international

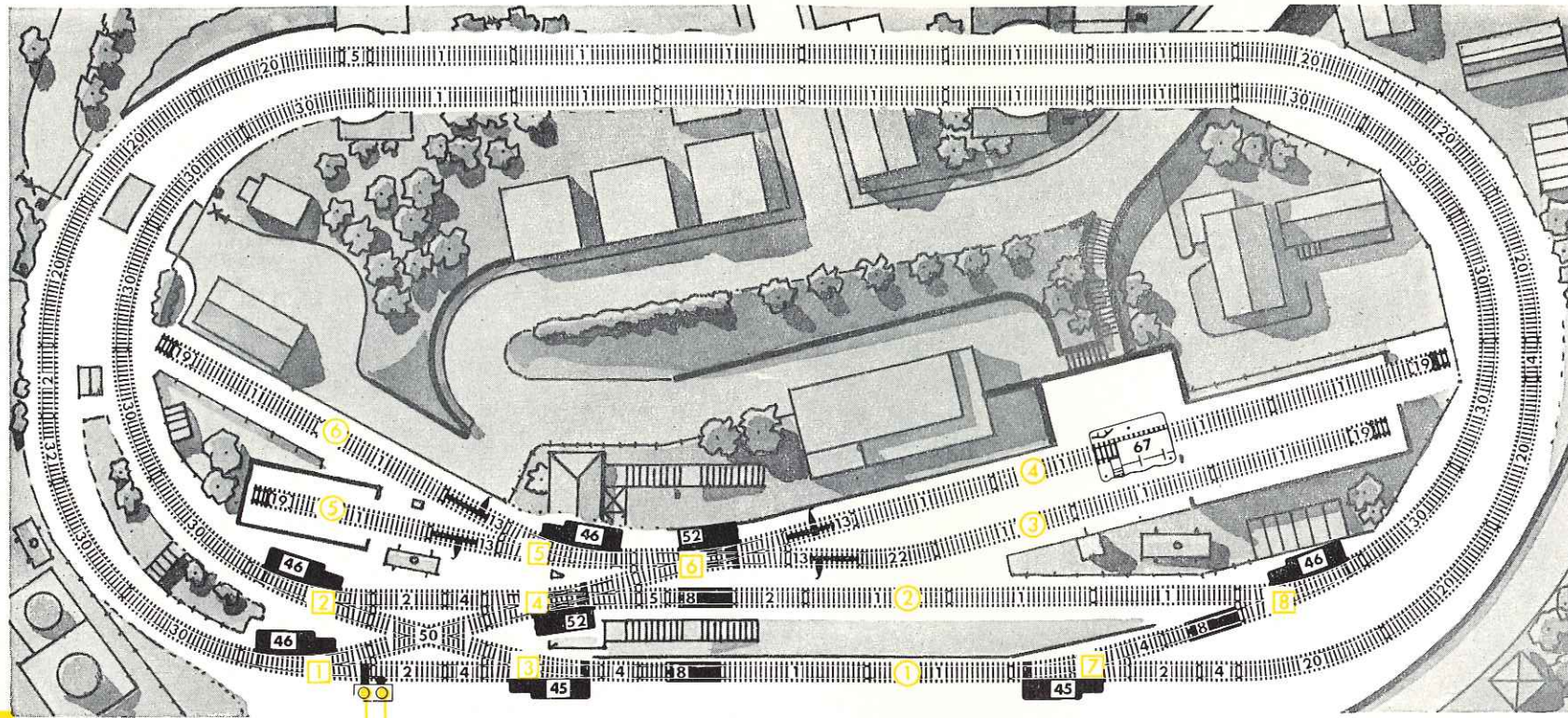

Symb. N°	1	2	4	5	8
Art. N°	..00	..00/2	..00/4	..00/5	..10
	27x	5x	6x	2x	3x

Symb. N°	13	19	20	22	30	32
Art. N°	..00/2 E	..88	..01	..01½	..03	..03½
	4x	4x	9x	1x	12x	1x

Symb. N°	45	46	50	52		67	<b>I</b>
Art. N°	..22	..21	..12	..25	60	67	711 712
	1 P.	2 P.	1x	2x	1x	1x	1x

# M

## 4244

2,20m x 1,00m

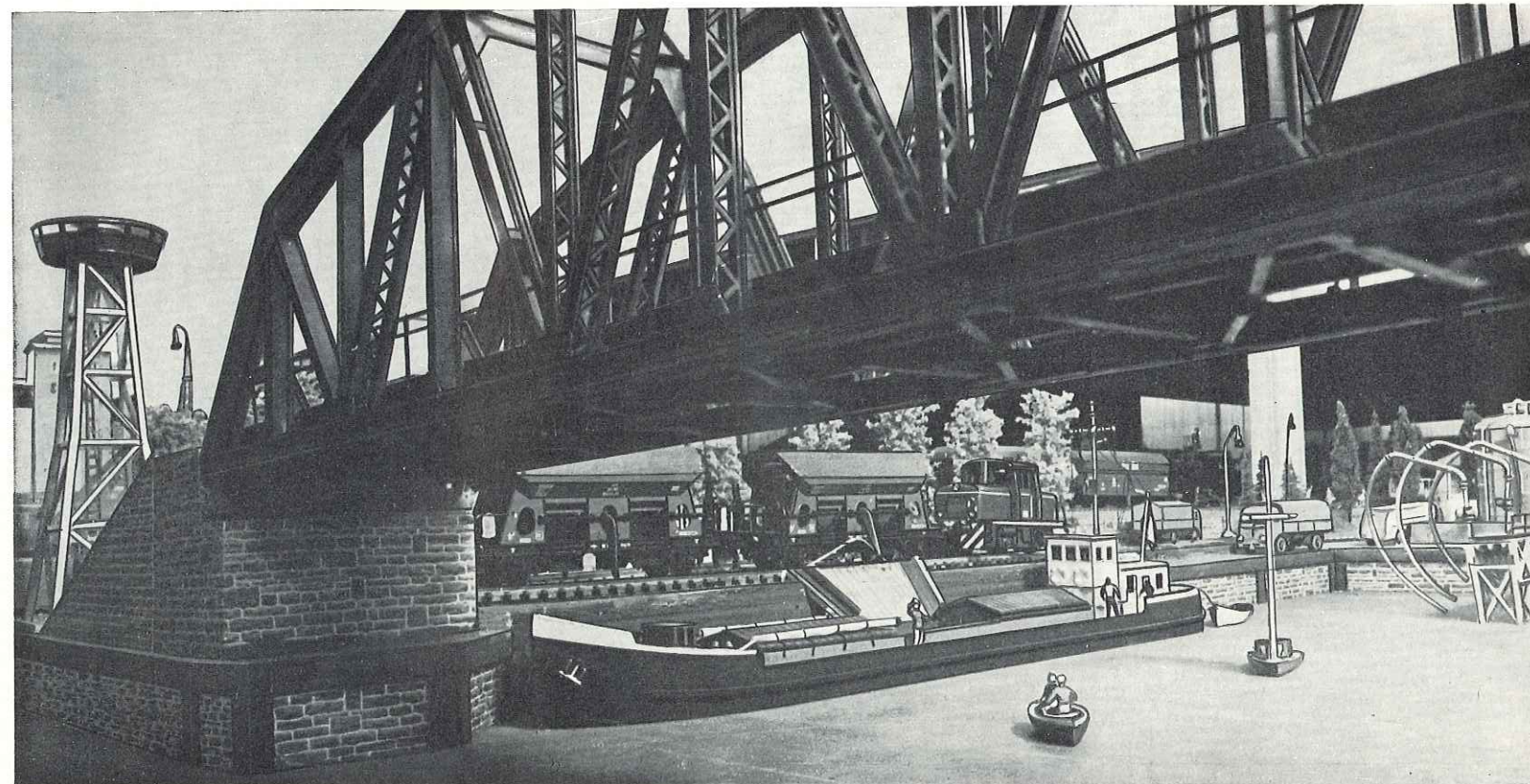



# FLEISCHMANN

international



Symb. N°	1	2	4	8	13	14	19
Art. N°	· · 00	· · 00/2	· · 00/4	· · 10	· · 00/2E	· · 00/2EM	· · 88
	27x	5x	6x	3x	3x	1x	4x

Symb. N°	20	22	30	32	41	43	50	53
Art. N°	· · 01	· · 01½	· · 03	· · 03½	· · 24 A	· · 23 A	· · 12	· · 25 A
	9x	1x	12x	1x	1P	2P	1x	2x

Symb. N°									
Art. N°	60	62	78	1771	508	515	516	517	518
	2x	10x	6x	2x	1x	2x	4x	1x	2x

Symb. N°								
Art. N°	530	532	533	536	537	538	711	711
	8x	2x	3x	2x	1x	36x	1x	1x

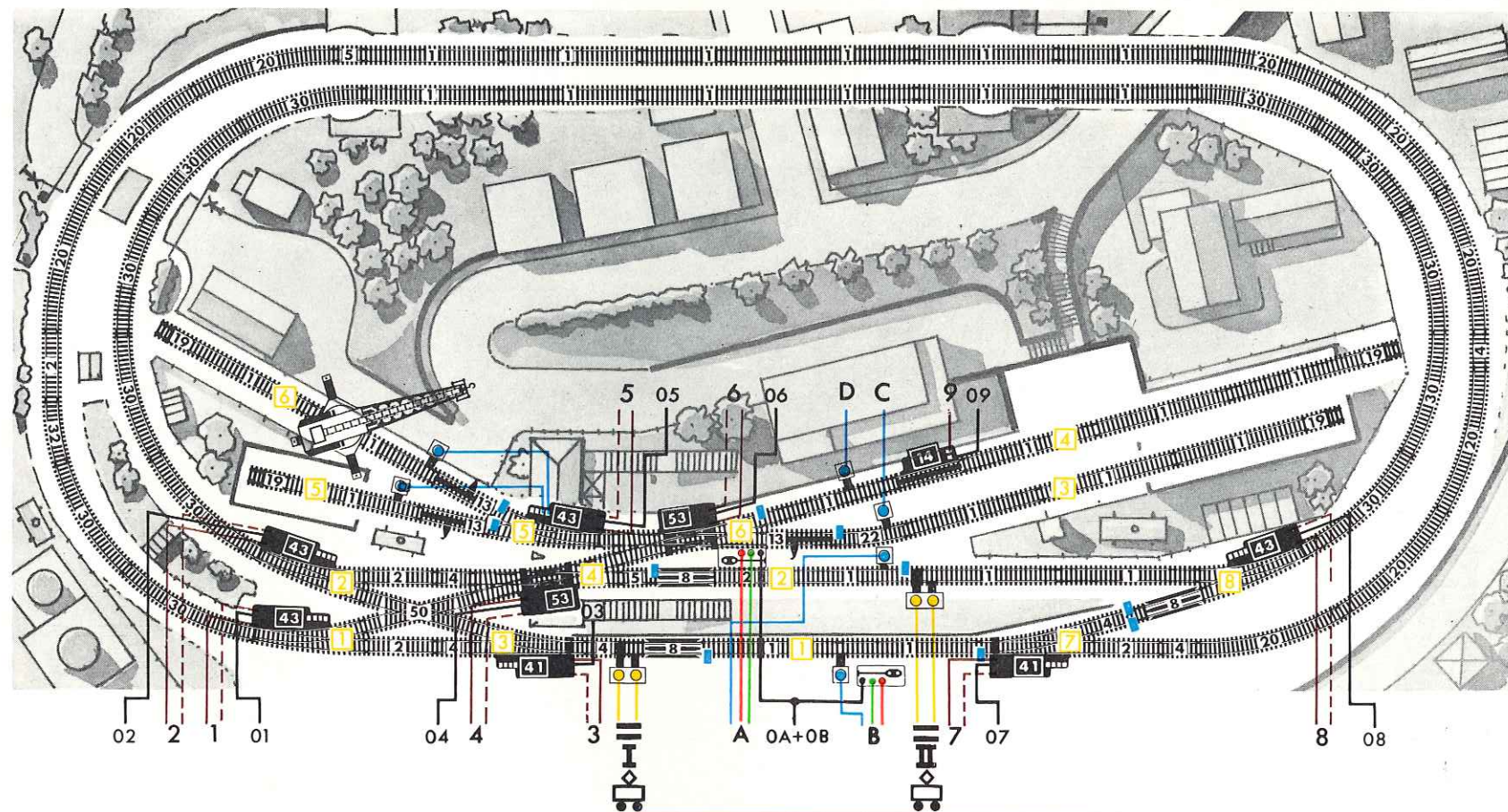

# M

## 4245

### PERFEKT

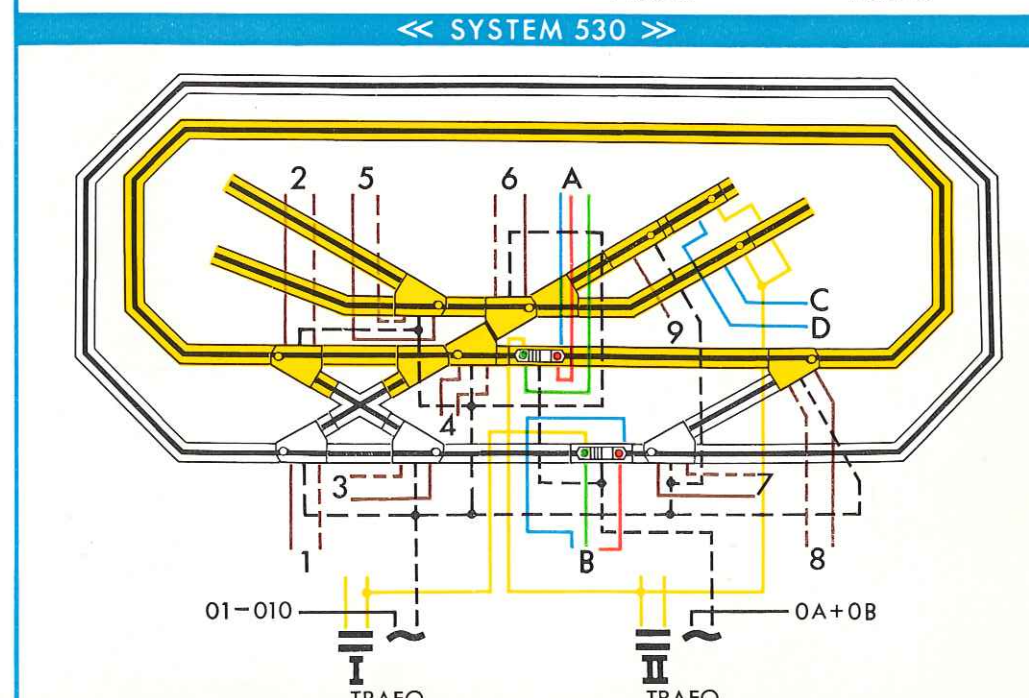
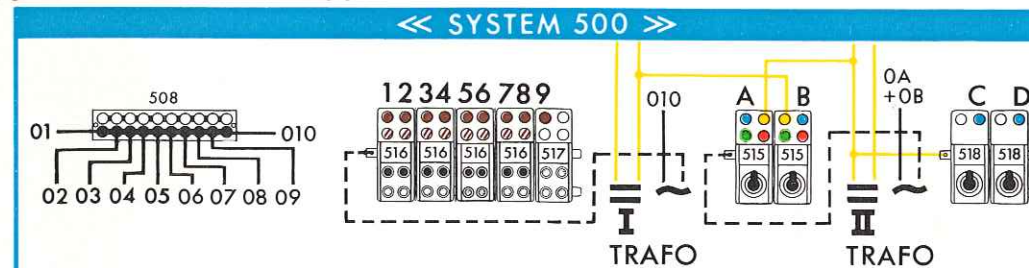
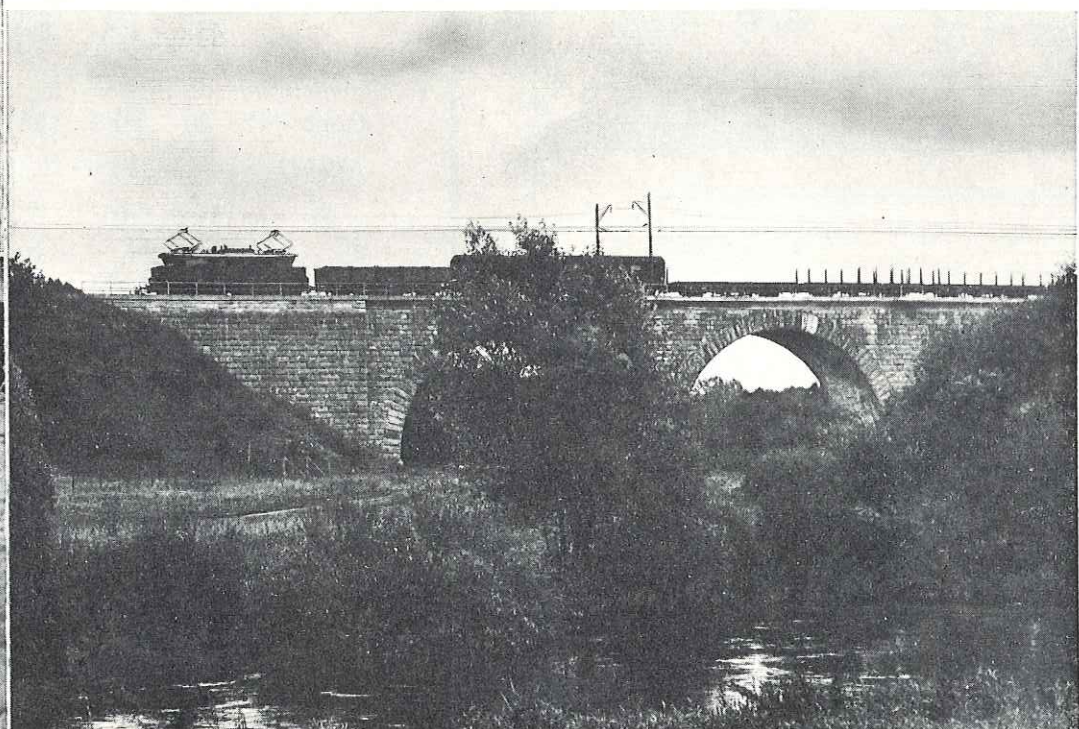
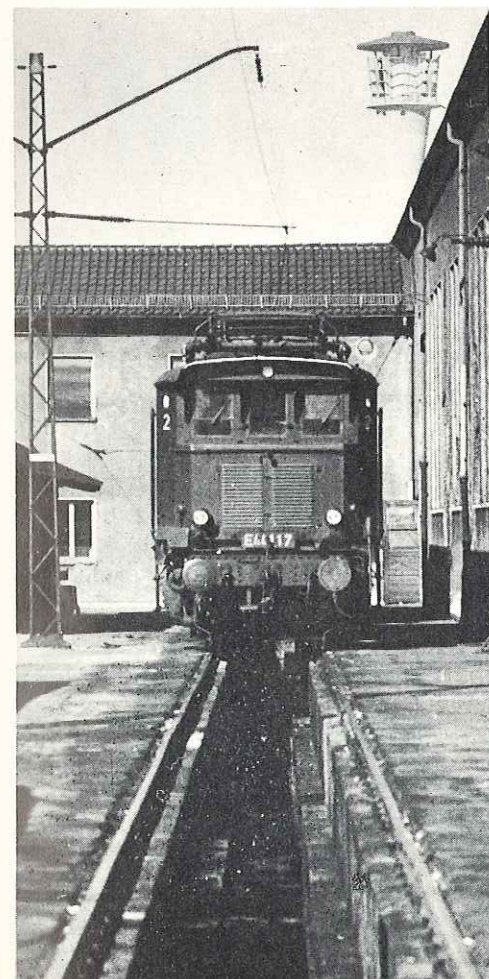

2,20 m x 1,00 m

: 1-2

: 1-2

: 1-2



# M

## 4246

### PERFEKT

2,15m x 1,00m

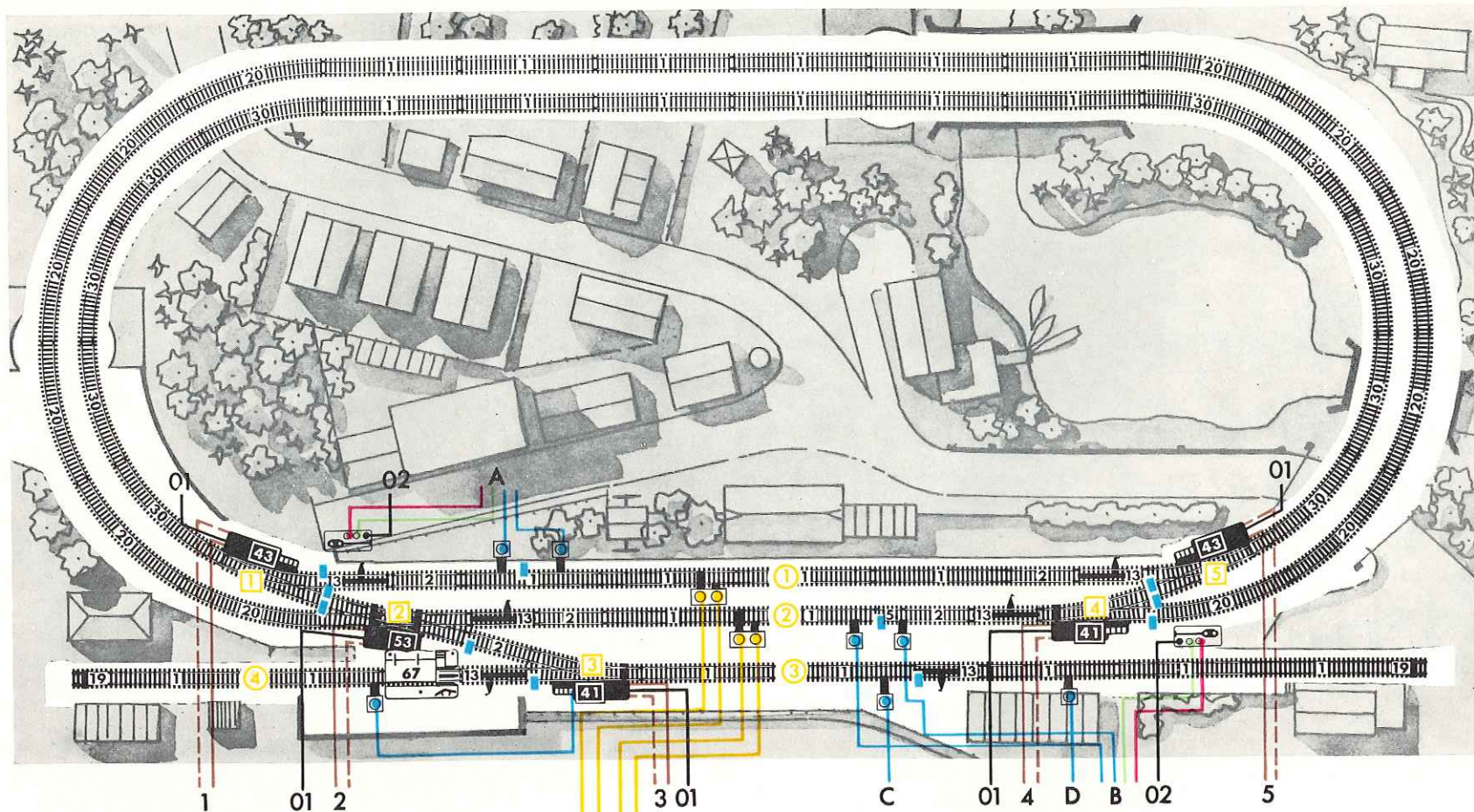

Symb. N°	1	2	5	8	13	19	20	30	41	43	53
Art. N°	· · 00	· · 00/2	· · 00/5	· · 10	· · 00/2 E	· · 88	· · 01	· · 03	· · 24 A	· · 23 A	· · 25 A
	25x	5x	1x	1x	6x	2x	12x	10x	1 P.	1 P.	1x

Symb. N°			67											I	II
Art. N°	60	62	67	78	515	516	518	1771	530	531	532	536	538	711	711
	2x	11x	1x	7x	2x	3x	2x	2x	5x	2x	2x	1x	32x	712	712

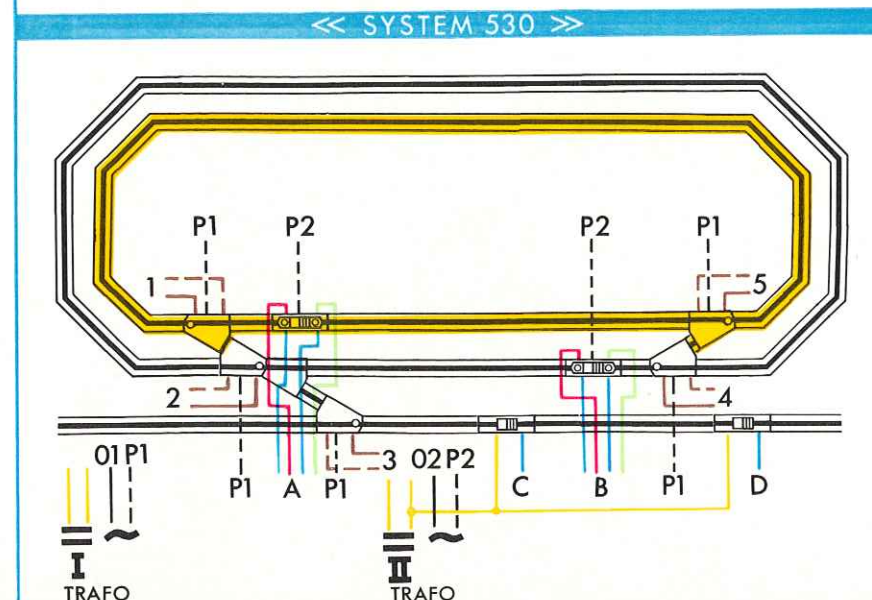
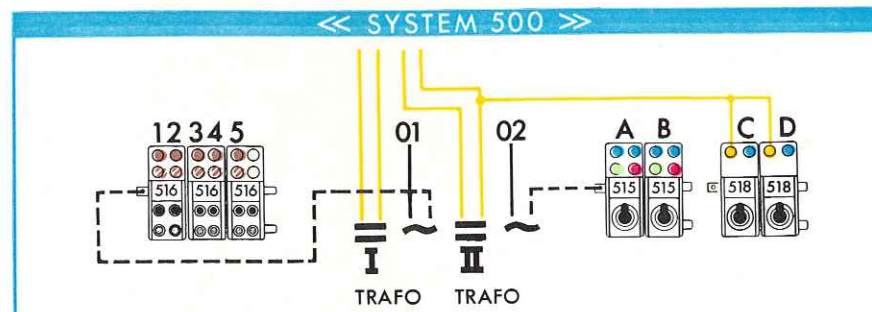

Symb. N°	1	2	4	5	8	13
Art. N°	· · 00	· · 00/2	· · 00/4	· · 00/5	· · 10	· · 00/2 E
	45x	10x	8x	5x	1x	13x

Symb. N°	19	20	21	22	23
Art. N°	· · 88	· · 01	· · 01/2	· · 01½	· · 01/3
	5x	10x	4x	7x	3x

Symb. N°	30	32	45	46	52
Art. N°	· · 03	· · 03½	· · 22	· · 21	· · 25
	6x	1x	1 P.	5 P.	1x

Symb. N°		64	64a	67	I
Art. N°	60	82	82/1	67	711
	1x	1x	1x	1x	712
					1x

Symb. N°	1	2	4	5	8	13	14	19
Art. N°	· · 00	· · 02/2	· · 00/4	· · 00/5	· · 10	· · 00/2 E	· · 00/2 EM	· · 88
	45x	10x	8x	5x	1x	12x	1x	5x

Symb. N°	20	21	22	23	30	32	41	43
Art. N°	· · 01	· · 01/2	· · 01½	· · 01/3	· · 03	· · 03½	· · 24 A	· · 23 A
	10x	4x	7x	3x	6x	1x	1 P.	5 P.

Symb. N°	53				64	64a	67			
Art. N°	· · 25 A	60	62	78	82	82/1	67	506	507	516
	1x	3x	24x	13x	1x	1x	1x	1x	1x	7x

Symb. N°										I	II
Art. N°	517	518	1771	530	531	533	534	536	538	711	711
	1x	1x	8x	13x	1x	2x	1x	1x	52x	712	712



# M

## 4247

2,40 m x 1,30 m

 : 1-2

 : 1

 : 1

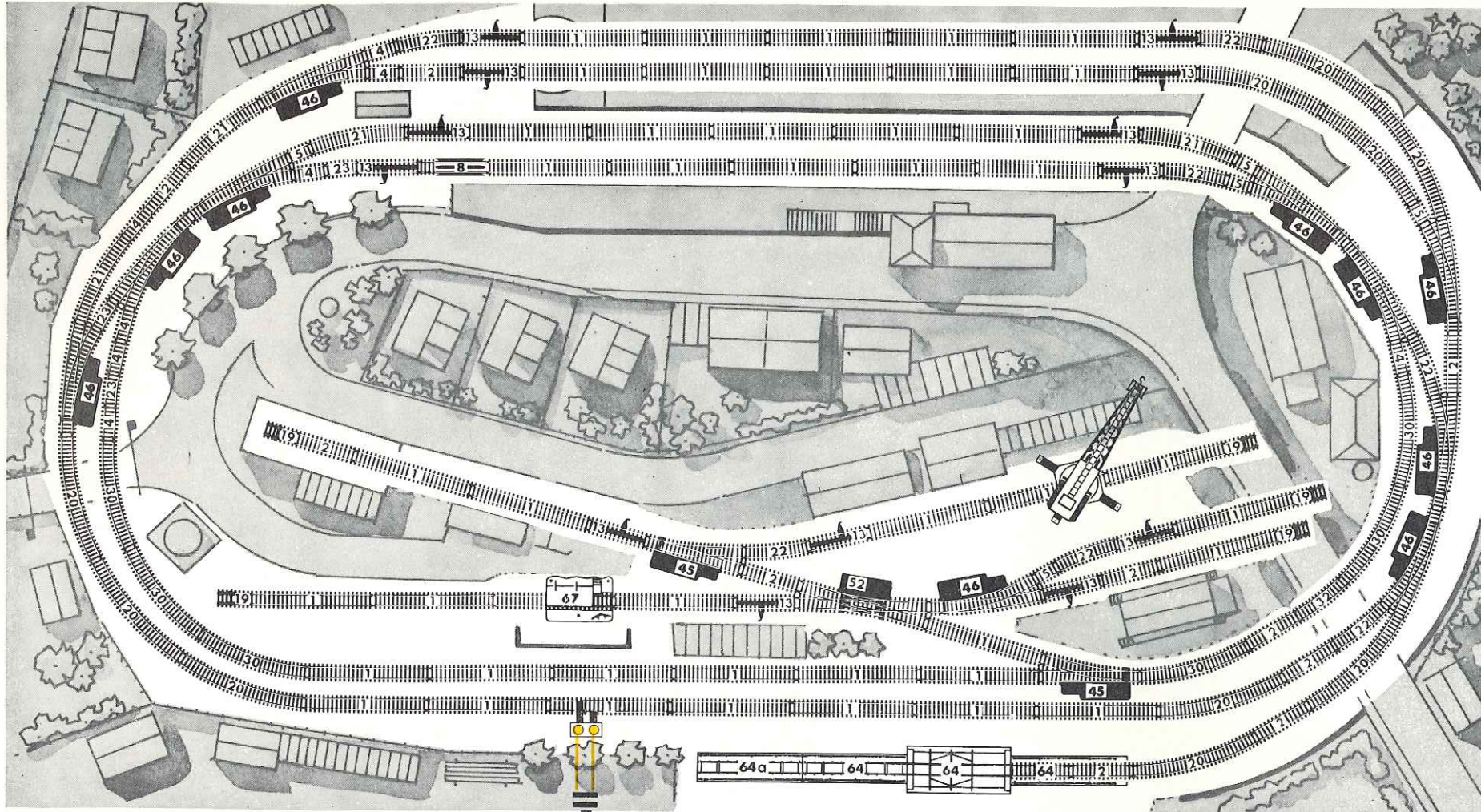

# M

## 4248

### PERFEKT

2,40 m x 1,30 m

 : 1-5

 : 1-3

 : 1-3

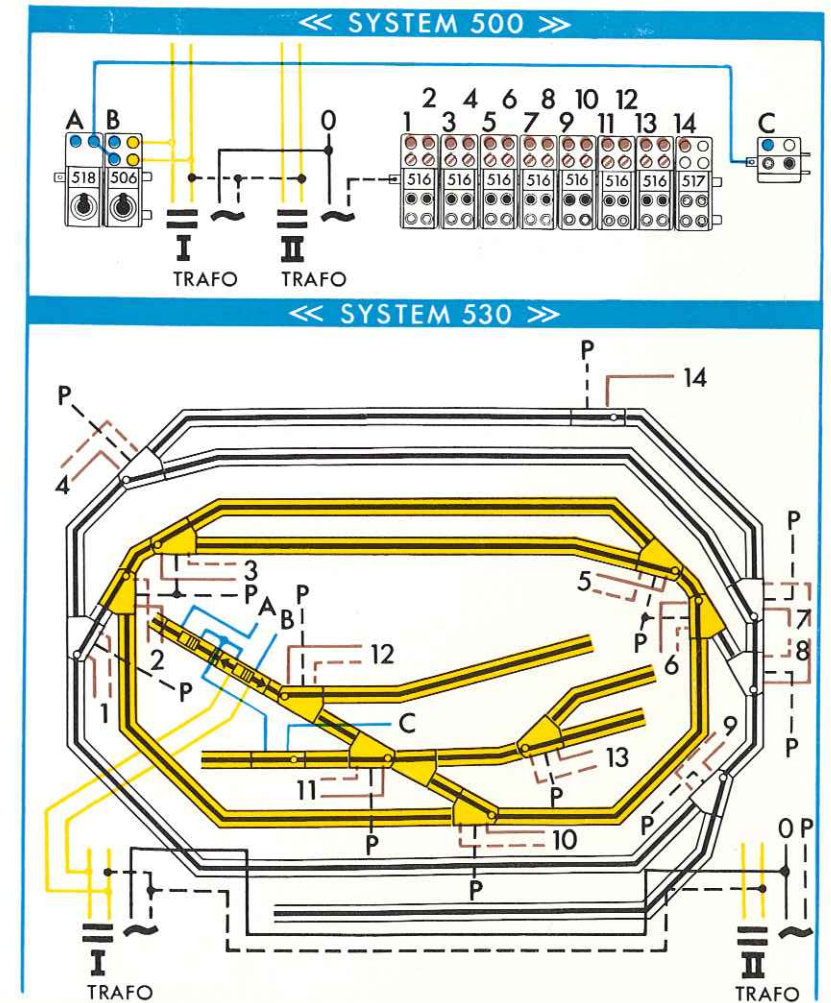
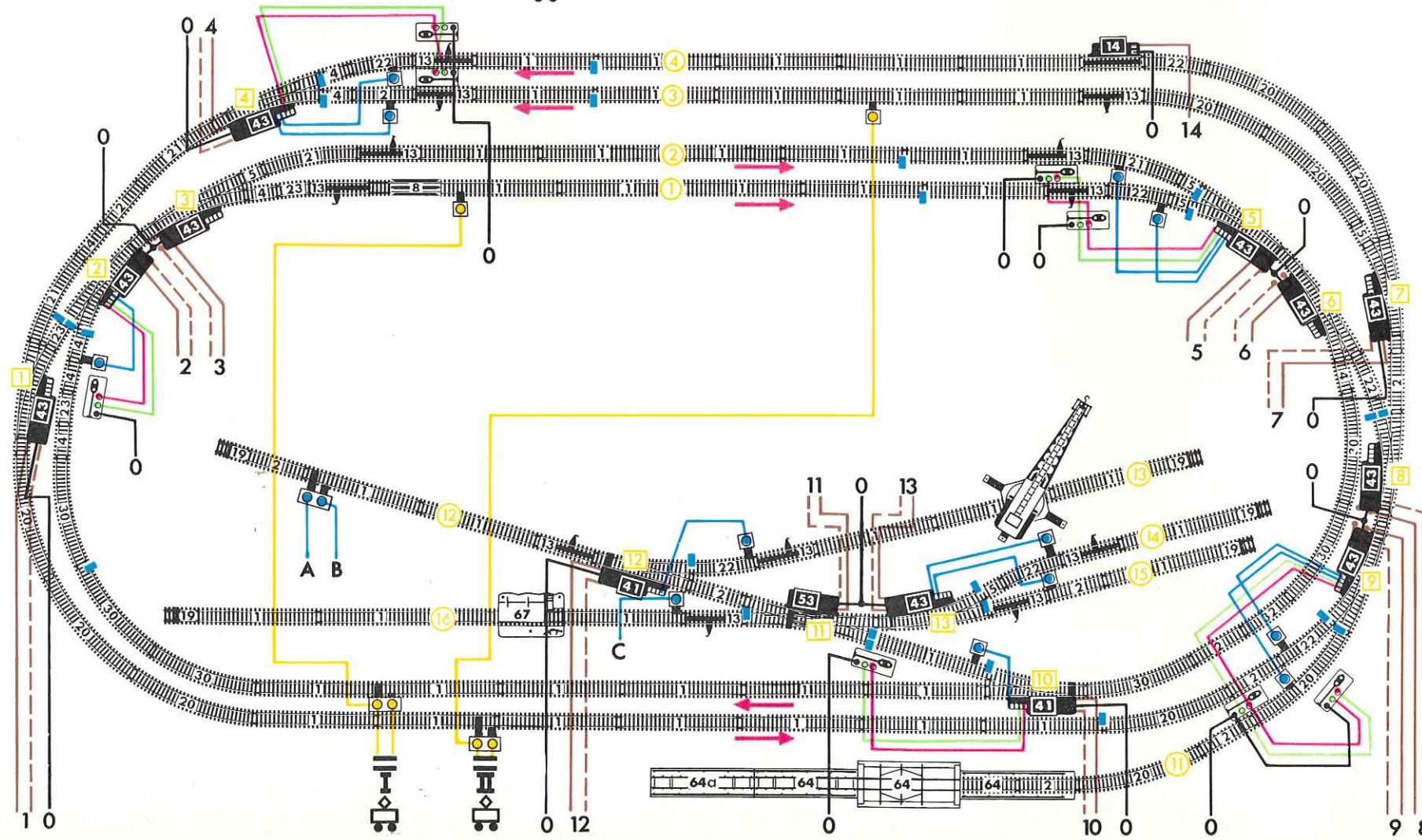

# FLEISCHMANN

international

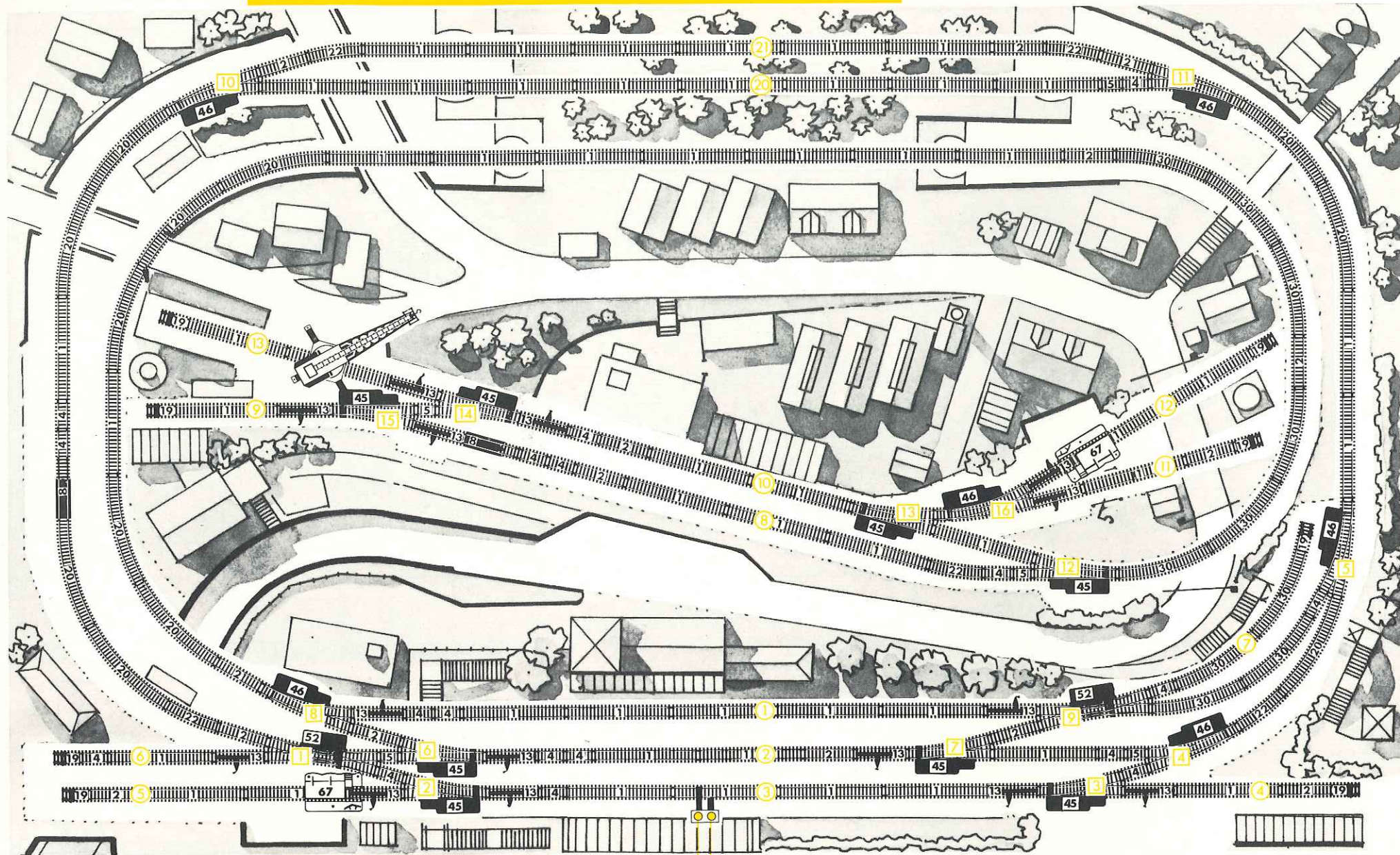
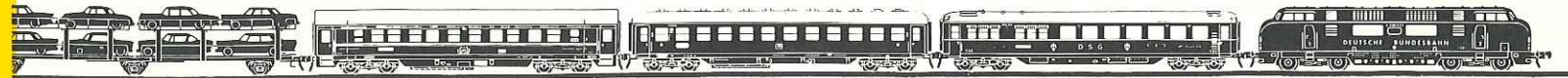
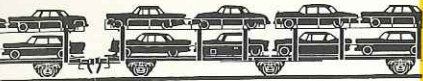

Symb. N°	1	2	4	5	8
Art. N°	..00	..00/2	..00/4	..00/5	..10
	53x	15x	15x	4x	2x

Symb. N°	13	19	20	22	30
Art. N°	..00/2E	..88	..01	..01 1/2	..03
	15x	8x	12x	5x	10x

Symb. N°	45	46	52		67	<b>I</b>
Art. N°	..22	..21	..25	60	67	711 712
	4 P.	3 P.	2x	1x	2x	1x

# M

## 4249

2.55 m x 1.50 m

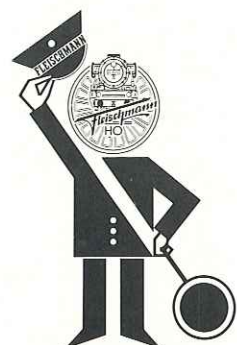
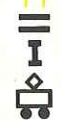



# FLEISCHMANN

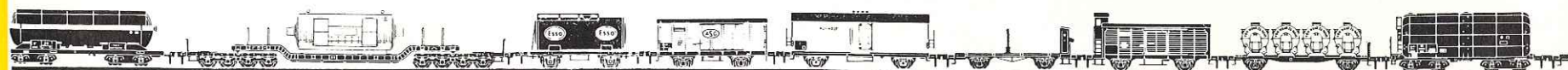

international



# M

## 4250

2,85m x 1,75m

-  : 1-5
-  : 1-3
-  : 1-3

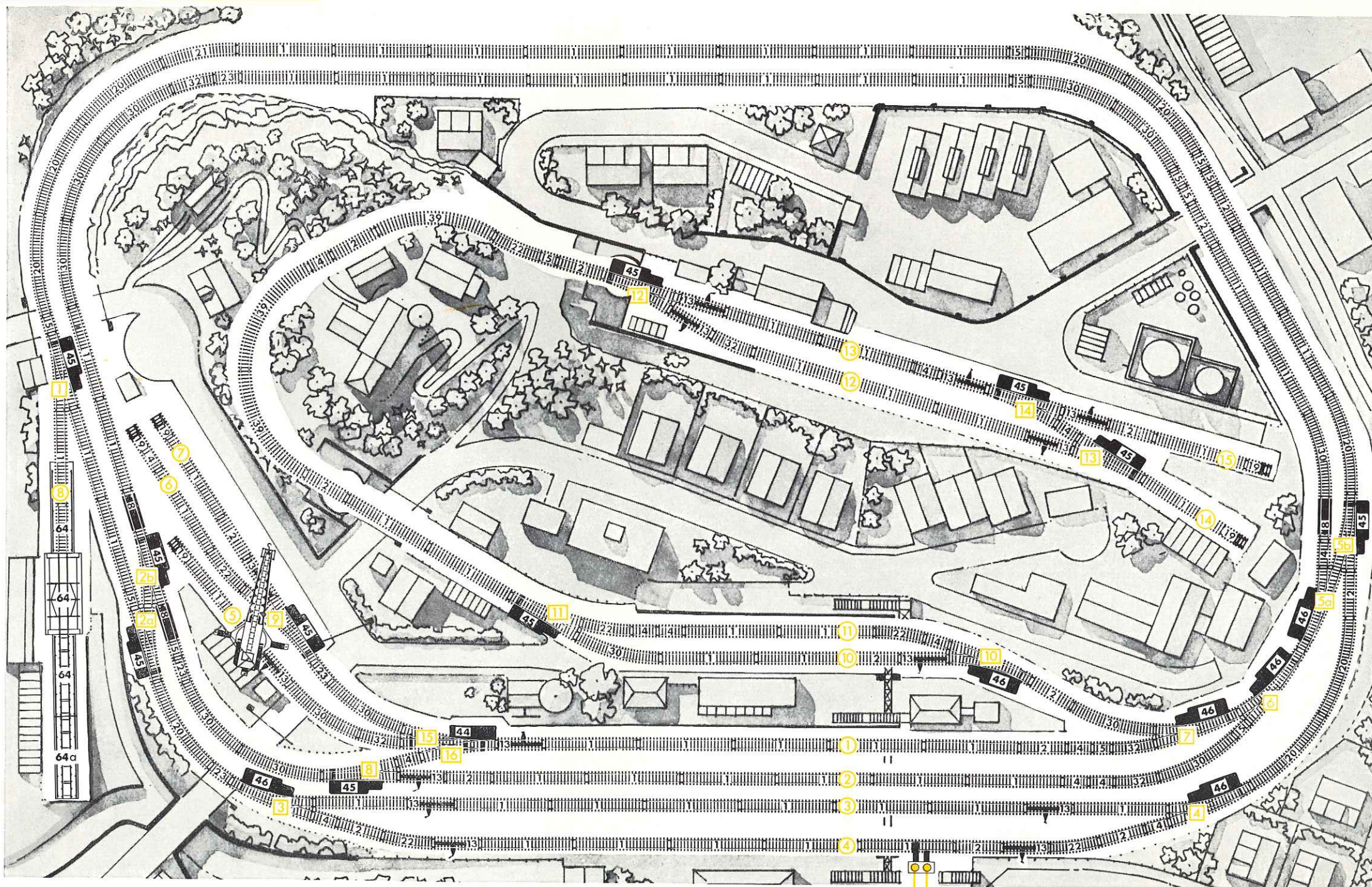
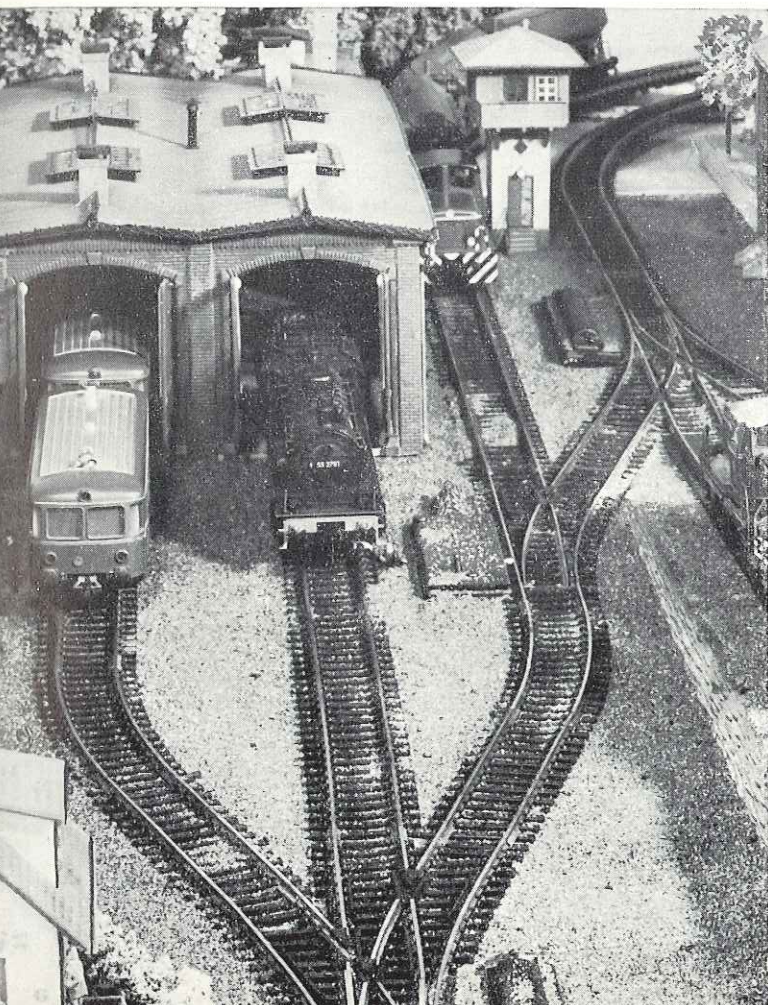

Symb. N°	1	2	4	5	8	13	19	20	21	22
Art. N°	..00	..00/2	..00/4	..00/5	..10	..00/2 E	..88	..01	..01/2	..01 1/2
	65x	15x	12x	13x	3x	14x	5x	9x	1x	6x

Symb. N°	23	30	32	39	44	45	46		64	64a	<b>I</b>
Art. N°	..01/3	..03	..03 1/2	..06	..26 A	..22	..21	60	82	82/1	711 712
	4x	13x	5x	3x	1x	5 P.	3 P.	1x	1x	1x	1x





**M**

4300

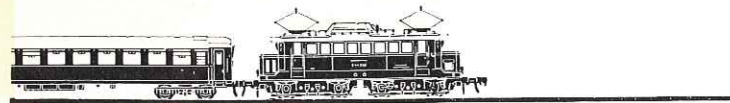

Symb. N°	14	41	43	53																<b>I</b>	
Art. N°	00/2 EM	24 A	23 A	25 A	60	62	67	78	506	507	516	517	518	1771	530	531	533	534	536	538	711
	1x	1 P.	2 P.	1x	2x	12x	1x	8x	1x	1x	4x	1x	1x	3x	7x	1x	2x	1x	1x	36x	712
																					1x

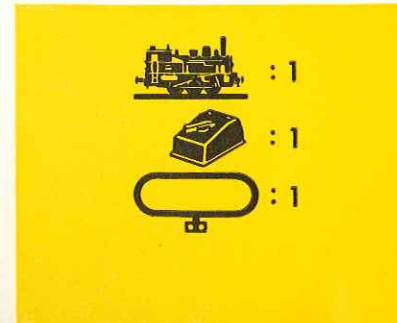
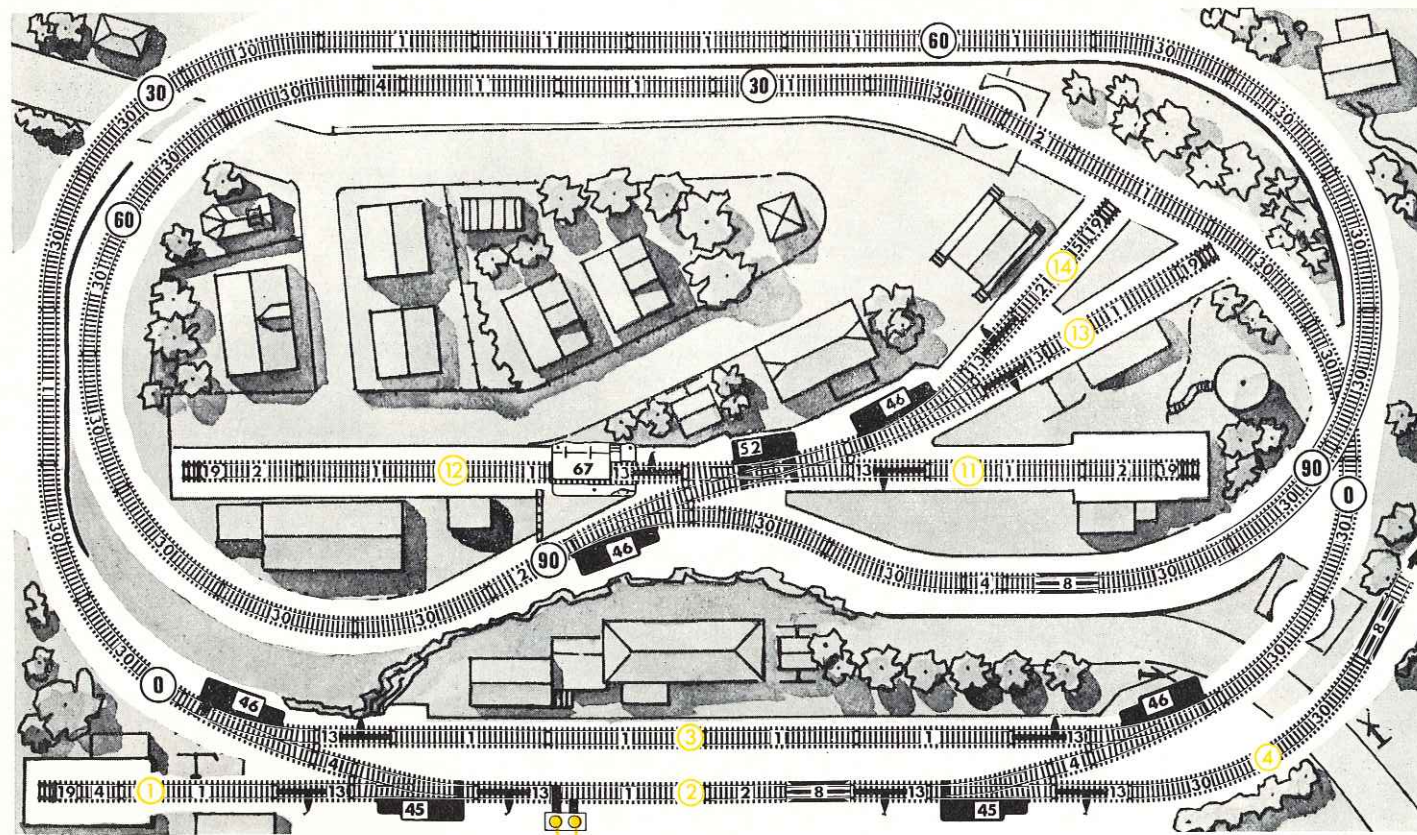

Symb. N°	1	2	4	5	8	13
Art. N°	00	00/2	00/4	00/5	10	00/2 E
	20x	6x	5x	1x	3x	10x

Symb. N°	19	30	45	46	52		67	<b>I</b>
Art. N°	88	03	22	21	25	60	67	711
	5x	27x	1 P.	2 P.	1x	1x	1x	712
								1x

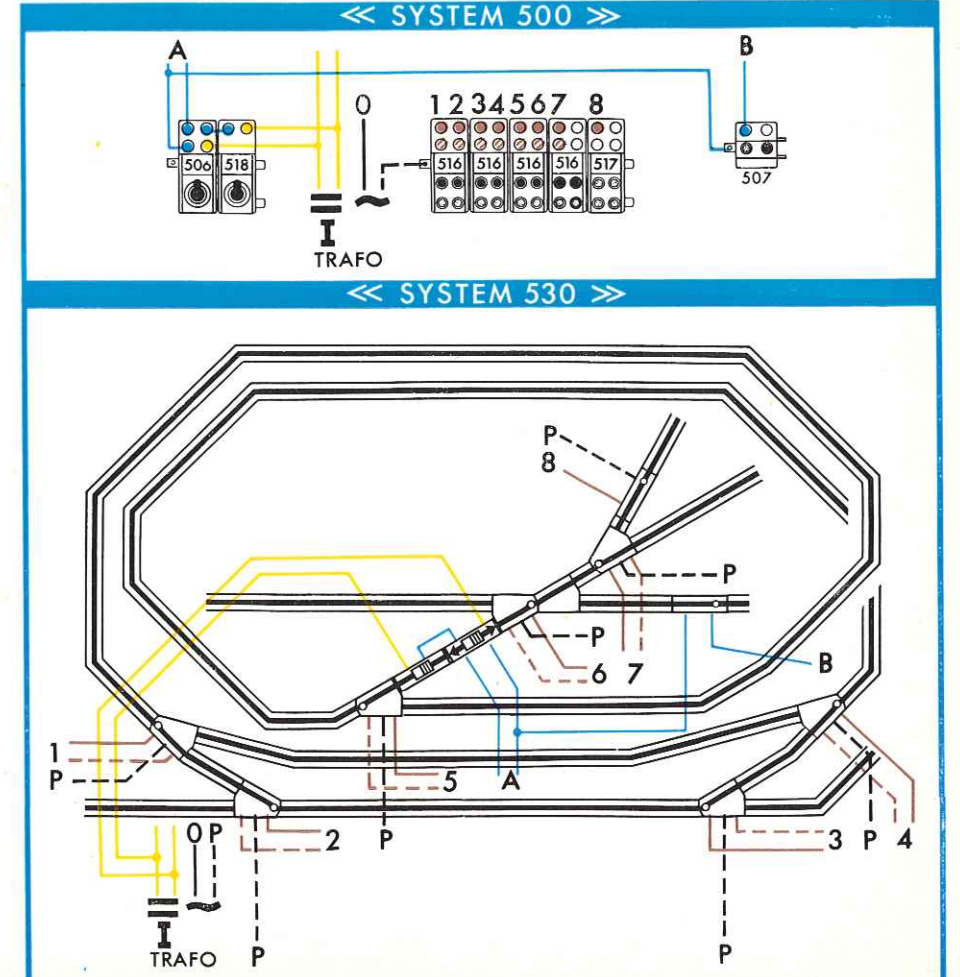
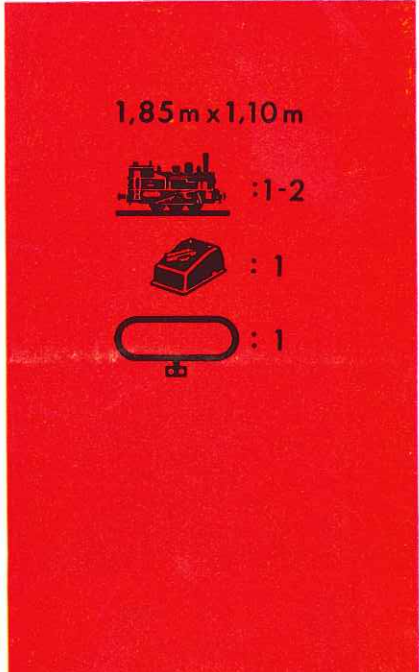
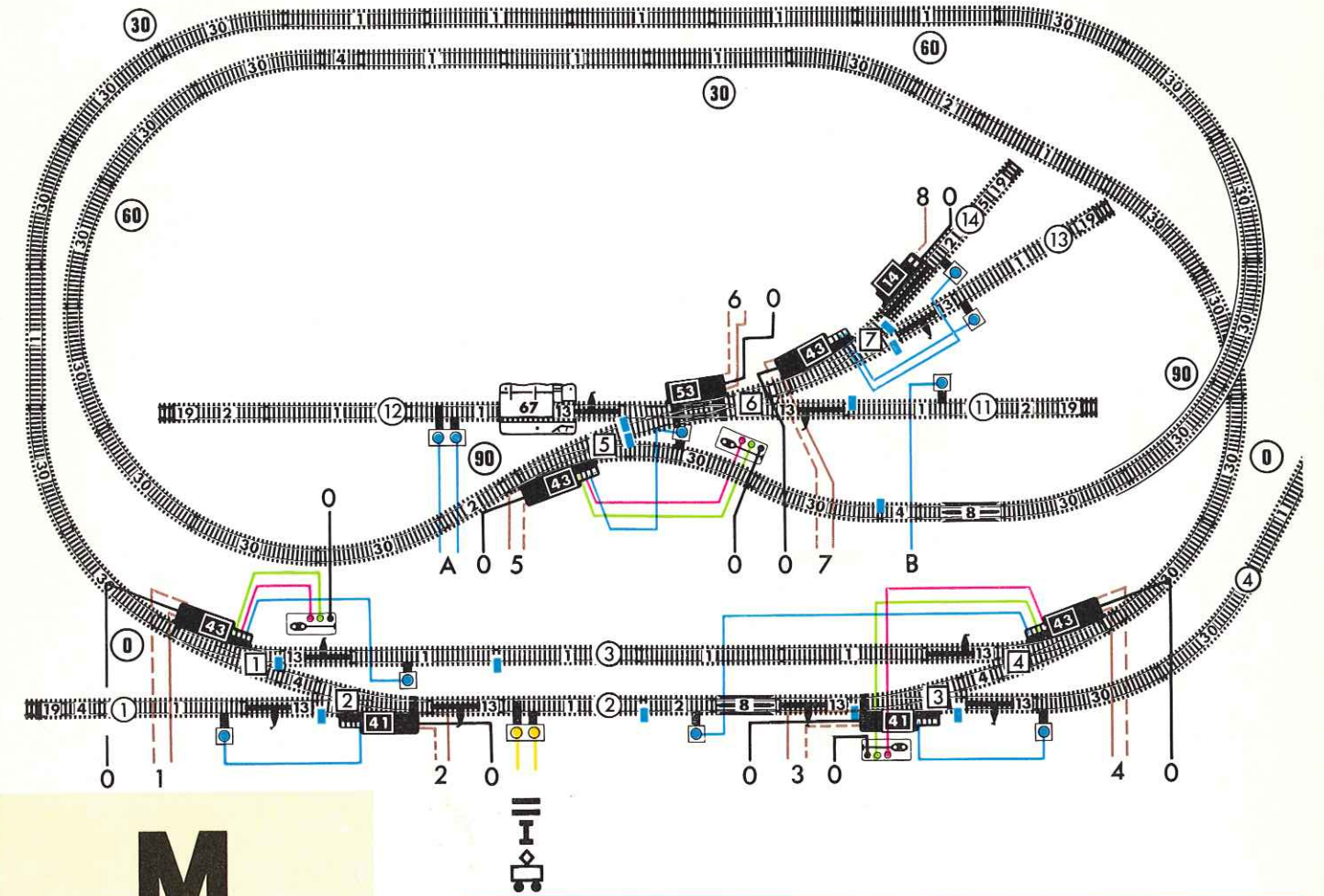

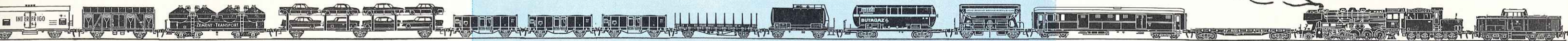

# FLEISCHMANN

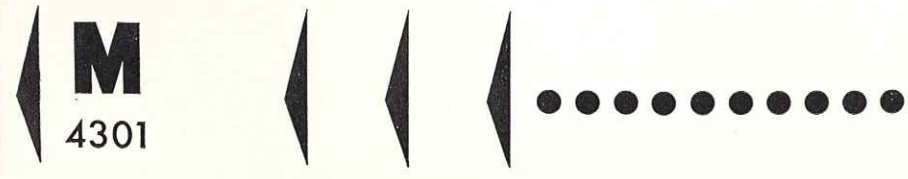
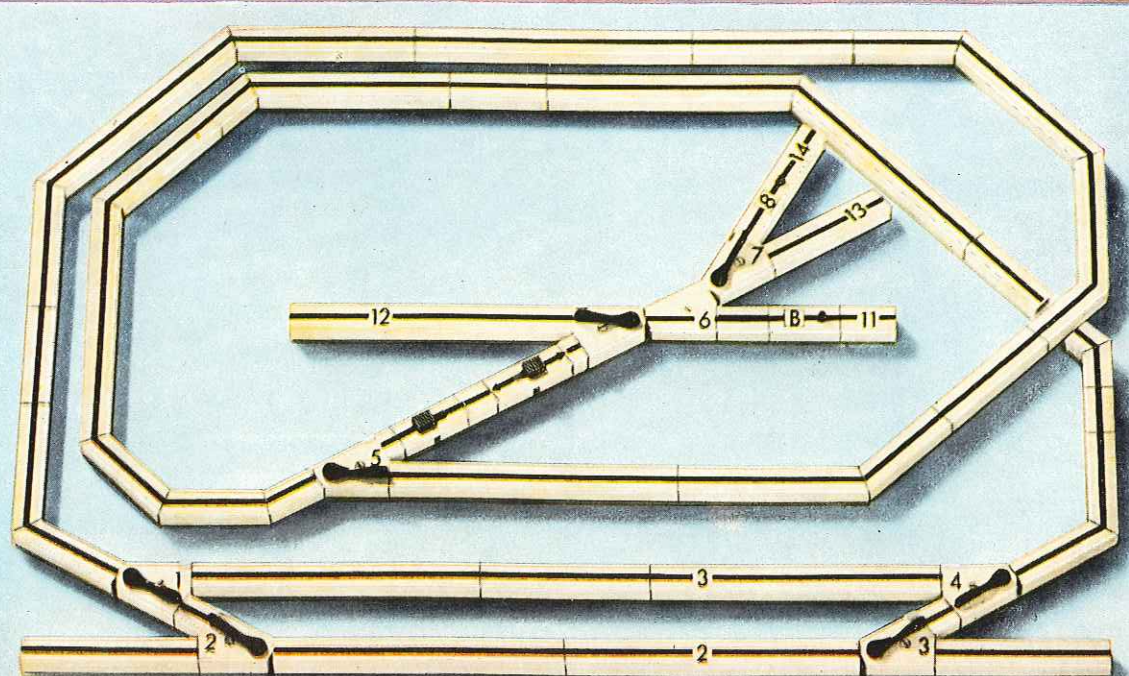



# FLEISCHMANN

international

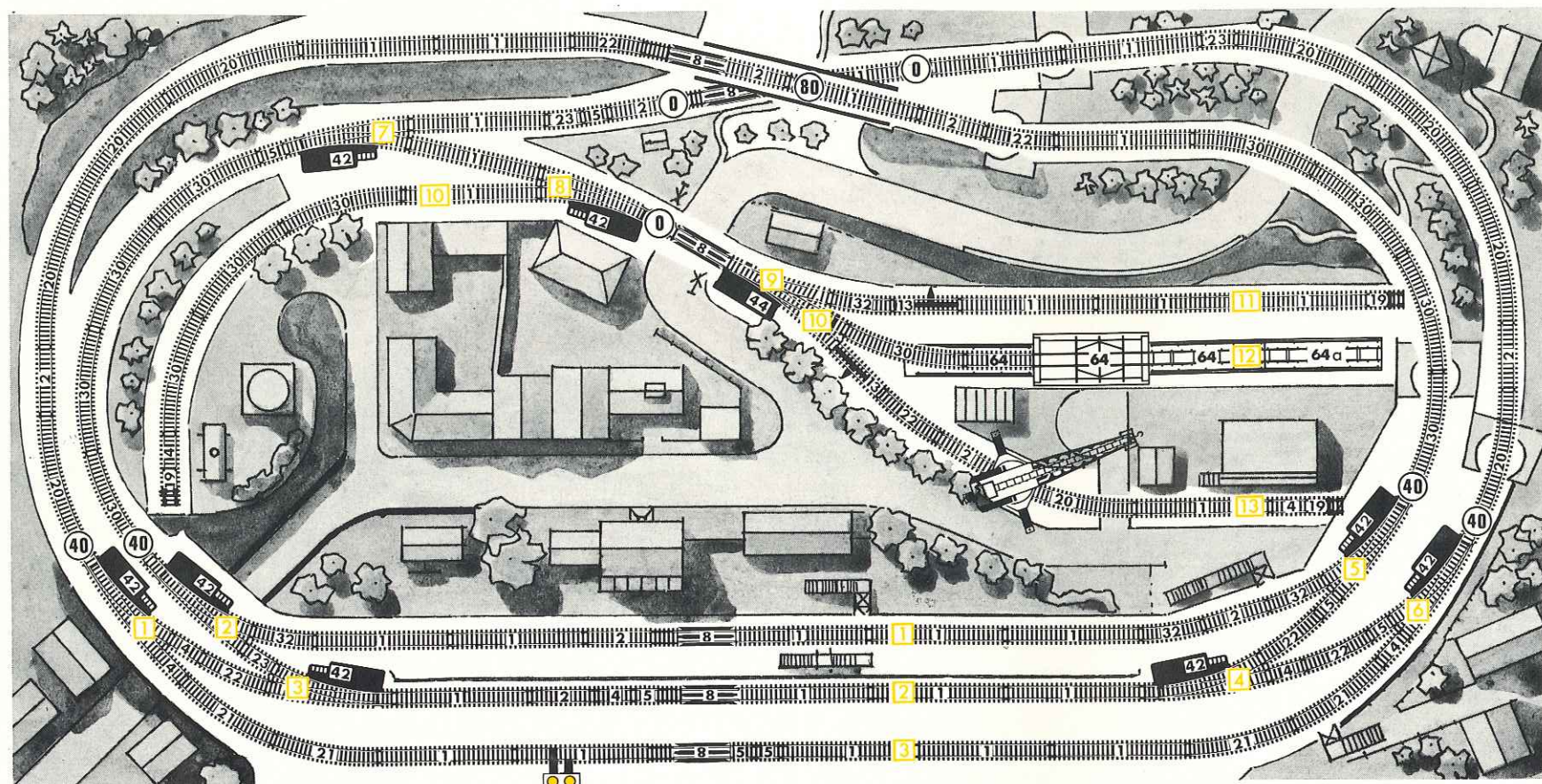

# M

## 4302



Symb. N°	1	2	4	5	8	13
Art. N°	..00	..00/2	..00/4	..00/5	..10	..00/2E
	28x	9x	8x	7x	6x	2x

Symb. N°	19	20	21	22	23	30
Art. N°	..88	..01	..01/2	..01½	..01/3	..03
	3x	9x	4x	6x	3x	12x

Symb. N°	32	42	44		64	64a	
Art. N°	..03½	..23	..26A	60	82	82/1	711 712
	4x	4 P.	1x	1x	1x	1x	1x

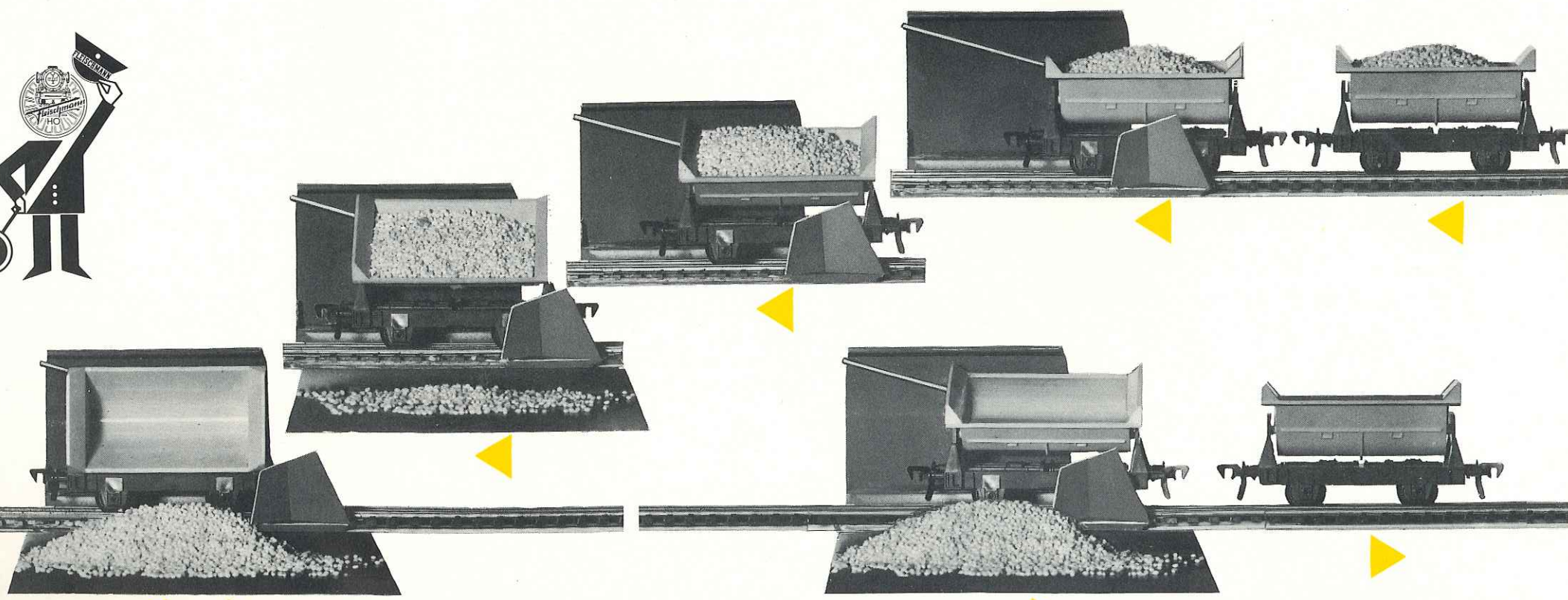

2,35 m x 1,20 m

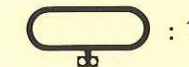

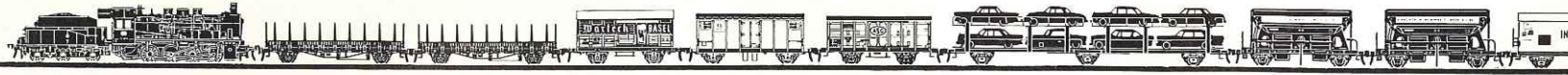

# FLEISCHMANN

international



Symb. N°	1	2	4	5	8	13
Art. N°	· · 00	· · 00/2	· · 00/4	· · 00/5	· · 10	· · 00/2 E
	28x	9x	8x	7x	6x	2x

Symb. N°	14	19	20	21	22	23	30
Art. N°	· · 00/2 EM	· · 88	· · 01	· · 01/2	· · 01½	· · 01/3	· · 03
	1x	3x	9x	4x	6x	3x	12x

Symb. N°	32	43	44			64a	
Art. N°	· · 03½	· · 23 A	· · 26 A	60	62	82	82/1 78
	4x	4 P.	1x	2x	19x	1x	20x

Symb. N°								
Art. N°	507	508	515	516	517	519	524	1771
	1x	1x	4x	4x	1x	4x	1x	7x

Symb. N°					<b>I</b>	<b>II</b>
Art. N°	530	532	533	538	711	711
	10x	4x	3x	41x	1x	1x

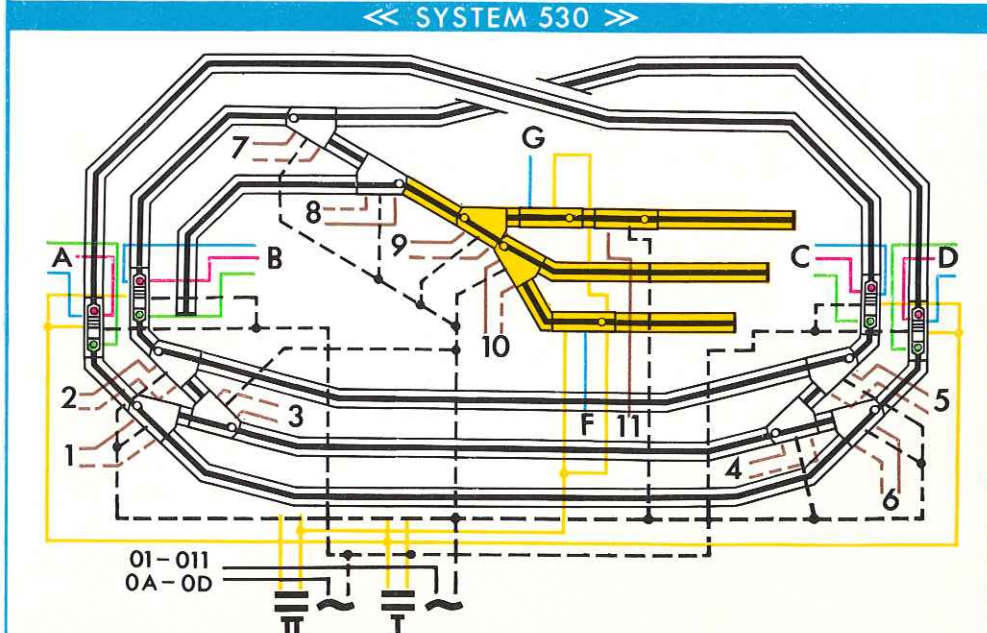
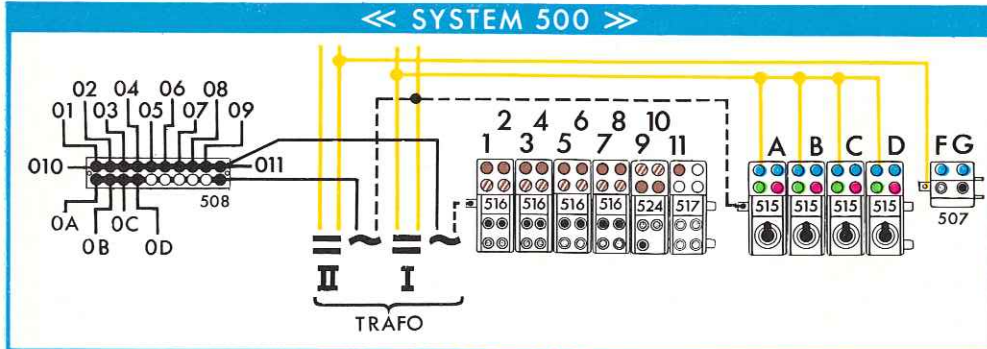
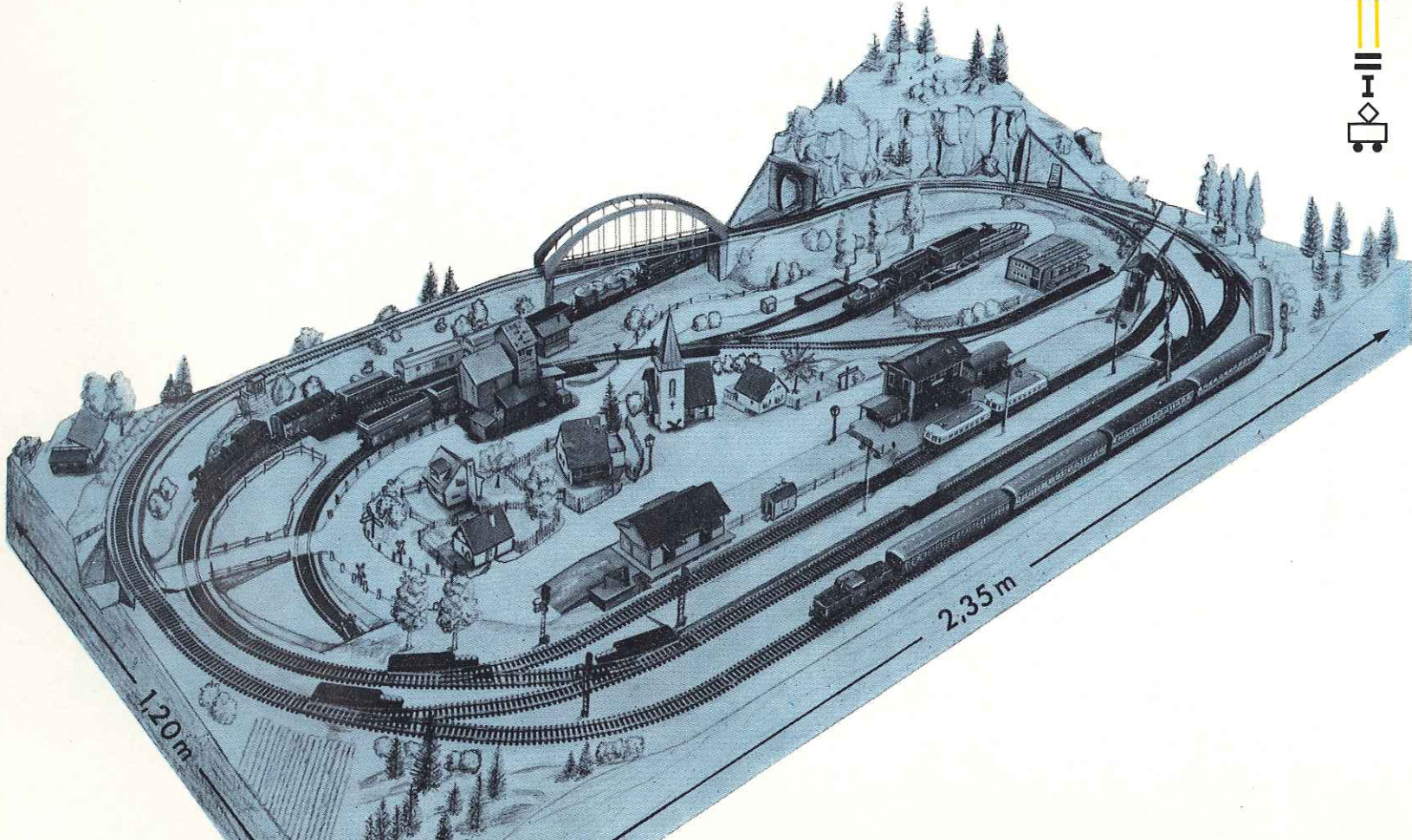
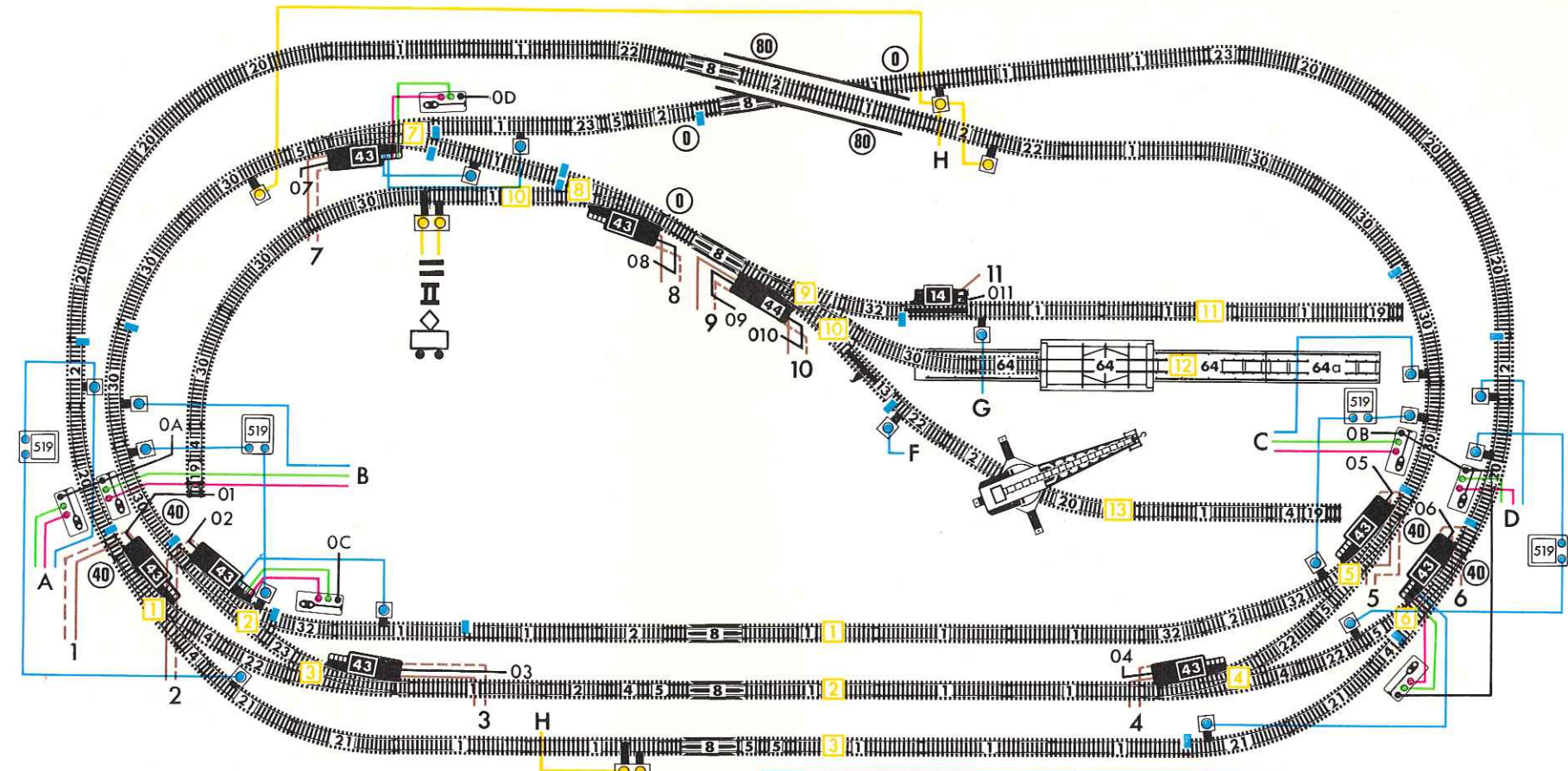

# M

4303

PERFEKT

2,35 m x 1,20 m

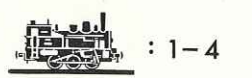

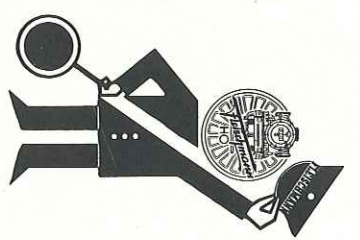
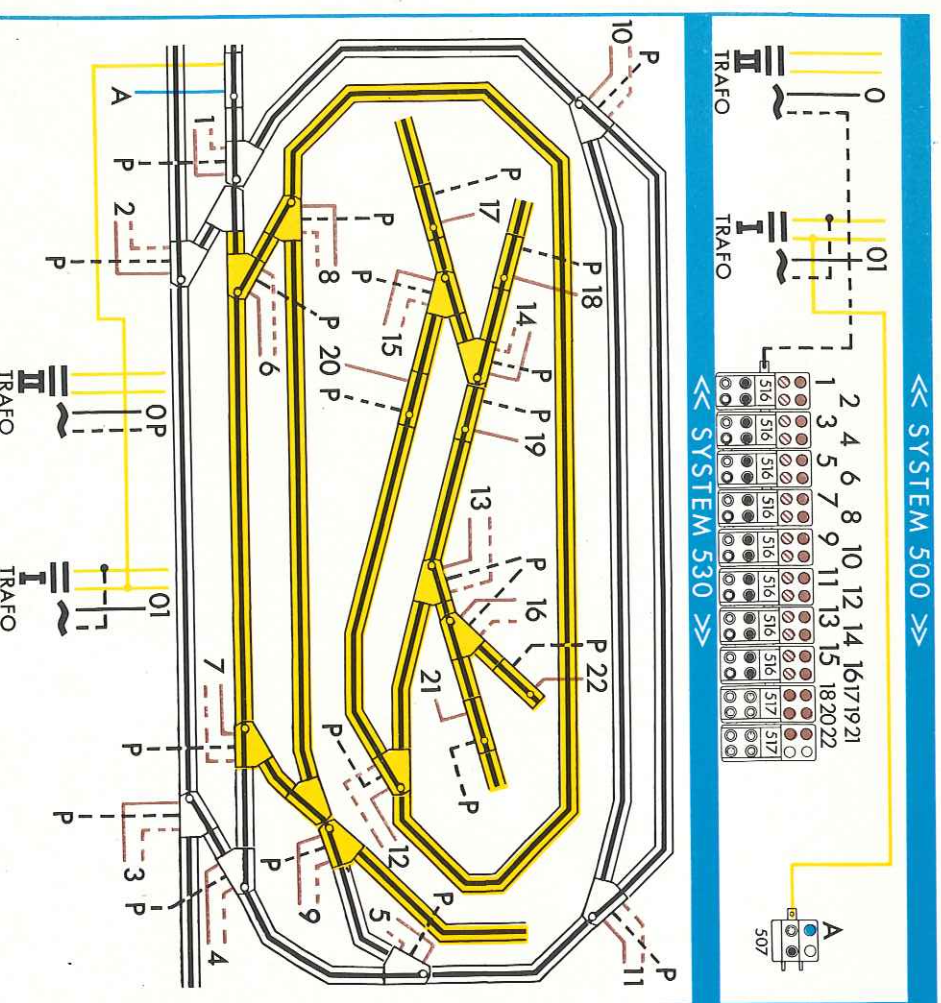
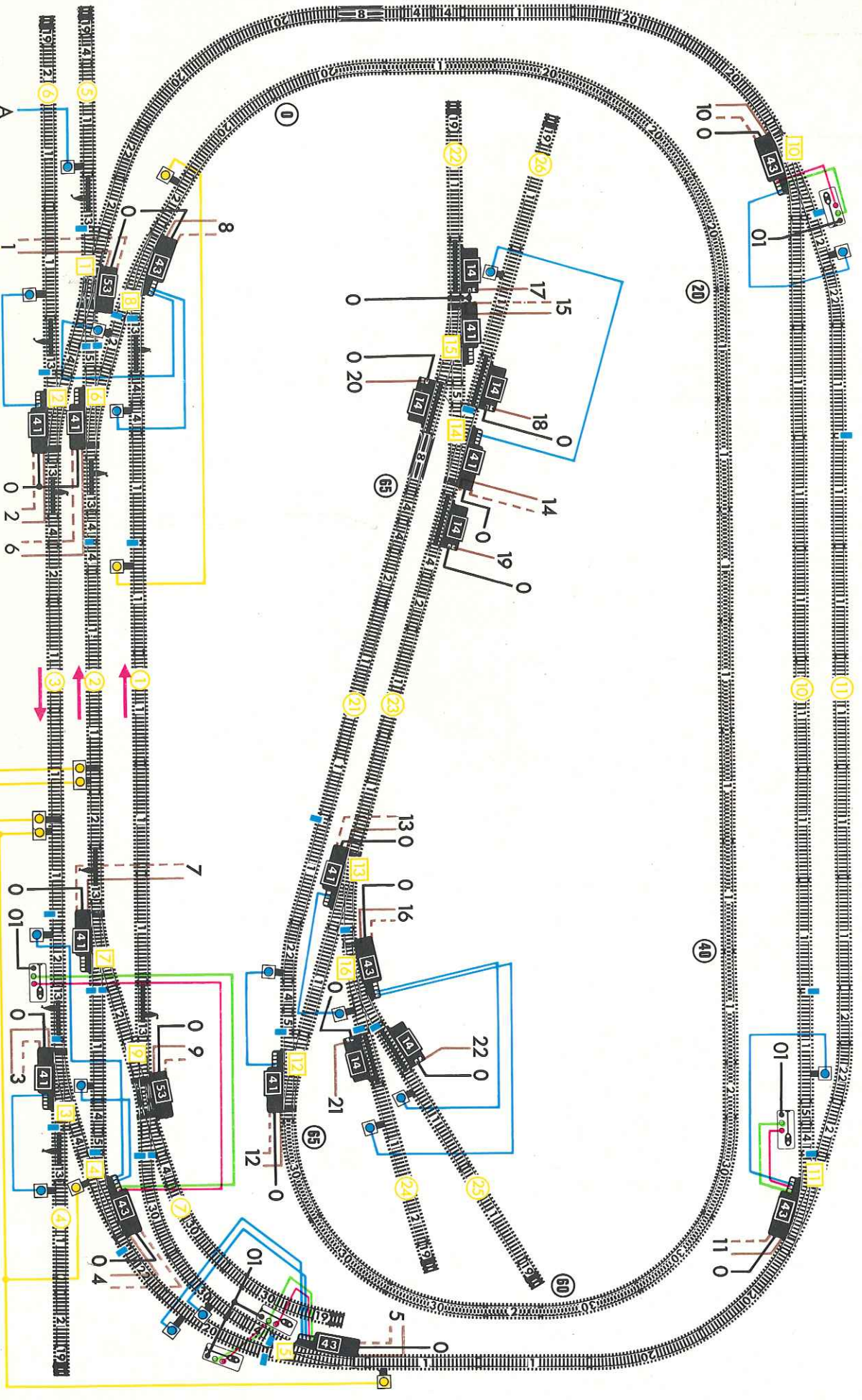

**M**  
**4304**  
**PERFEKT**

Symb. N°	1	2	4	5	8	13	14	19	20
Art. N°	..00	..00/2	..00/4	..00/5	..10	..00/2E	..00/2EM	..88	..01
Symb. N°	22	30	41	43	53				
Art. N°	..01½	..03	..24A	..23A	..25A	60	62	78	65
Symb. N°	507	516	517	8					
Art. N°	5x	10x	4P.	3P.	2x	2x	29x	20x	18x
Symb. N°	507	516	517	8					
Art. N°	1x	8x	2x	5x	16x	7x	2x	68x	
Symb. N°									
Art. N°									
Symb. N°									
Art. N°									

2.60m x 1.50m

: 1-3  
: 2  
: 2





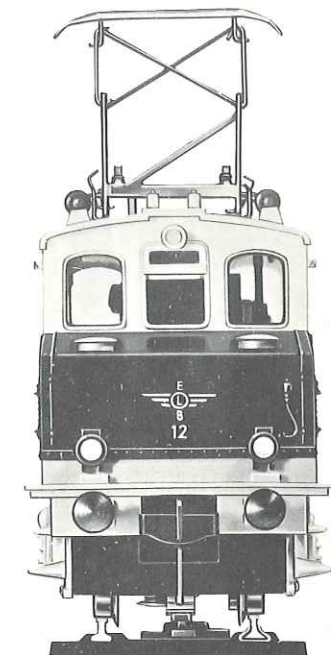
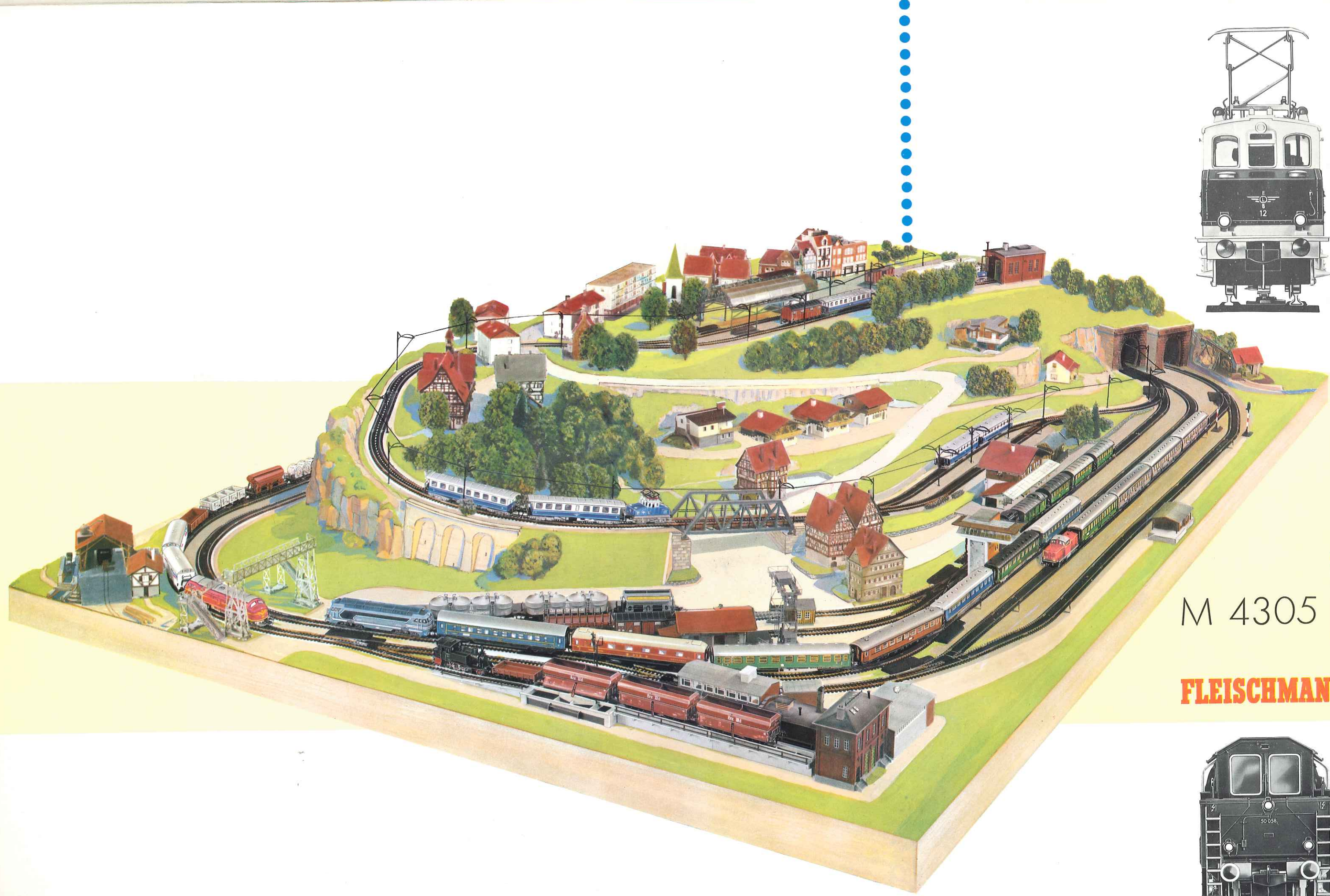

M 4305

**FLEISCHMANN**

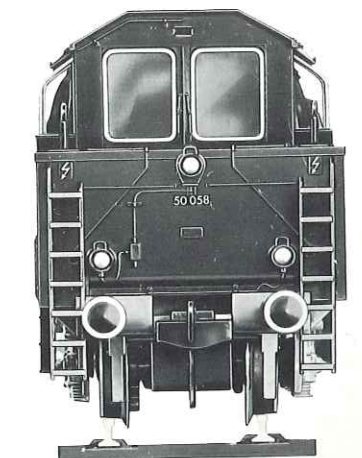



# M

## 4306

### PERFEKT

3,45m x 2,00m





 : 3-6

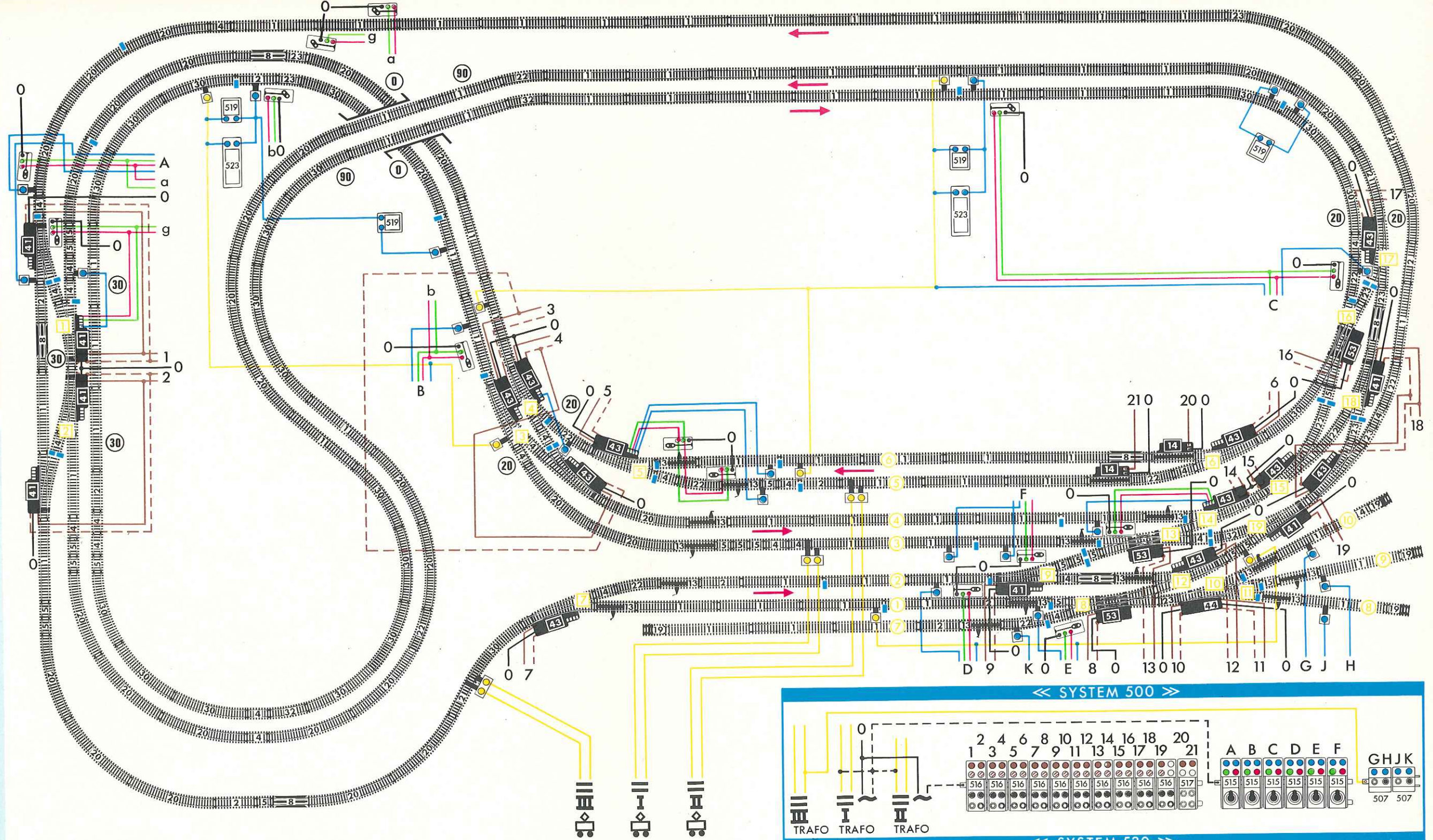













 : 3

 : 3



Symb. N°	-1	2	4	5	8	13	14	19	20	21	22	23
Art. N°	..00	..00/2	..00/4	..00/5	..10	..00/2E	..00/2EM	..88	..01	..01/2	..01½	..01/3
	75x	10x	26x	21x	6x	14x	2x	4x	38x	1x	10x	9x

Symb. N°	30	32	41	41	43	43	44	53					
Art. N°	..03	..03½	..24A	..24A	..23A	..23A	..26A	..25A	60	62	78	507	515
	20x	4x	3 P.	1x V	5 P.	1x V	1x	3x	3x	43 x	29x	2x	6x

Symb. N°														
Art. N°	516	517	519	523	1770	1771	530	532	533	536	538	711	711	711
	10x	1x	4x	2x	4x	10x	19x	6x	6x	7x	112x	1x	1x	1x

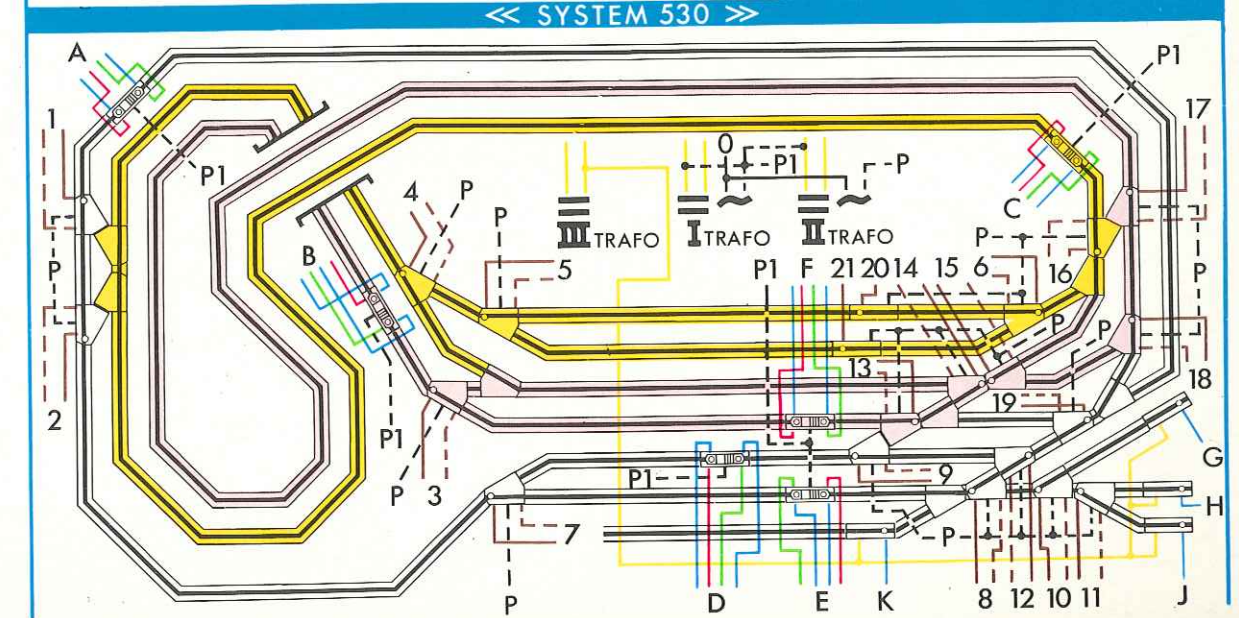
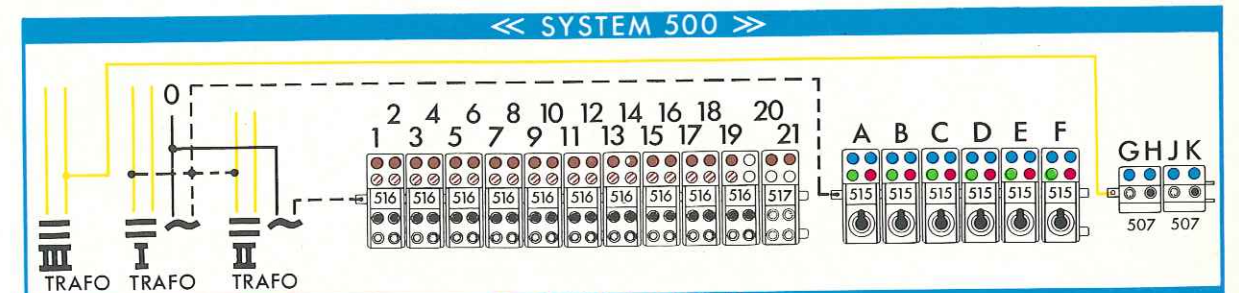

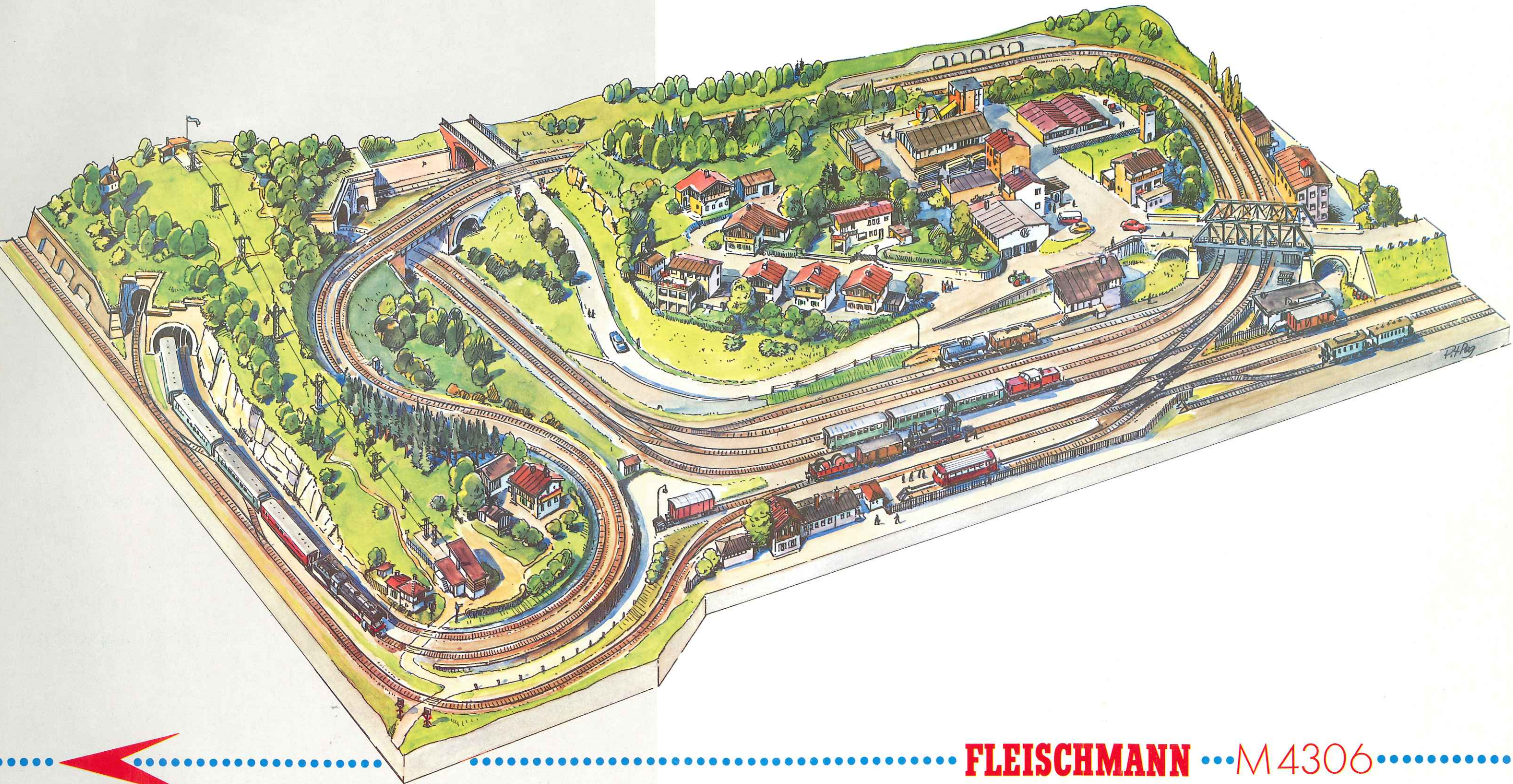

**FLEISCHMANN** •• M4306 ••

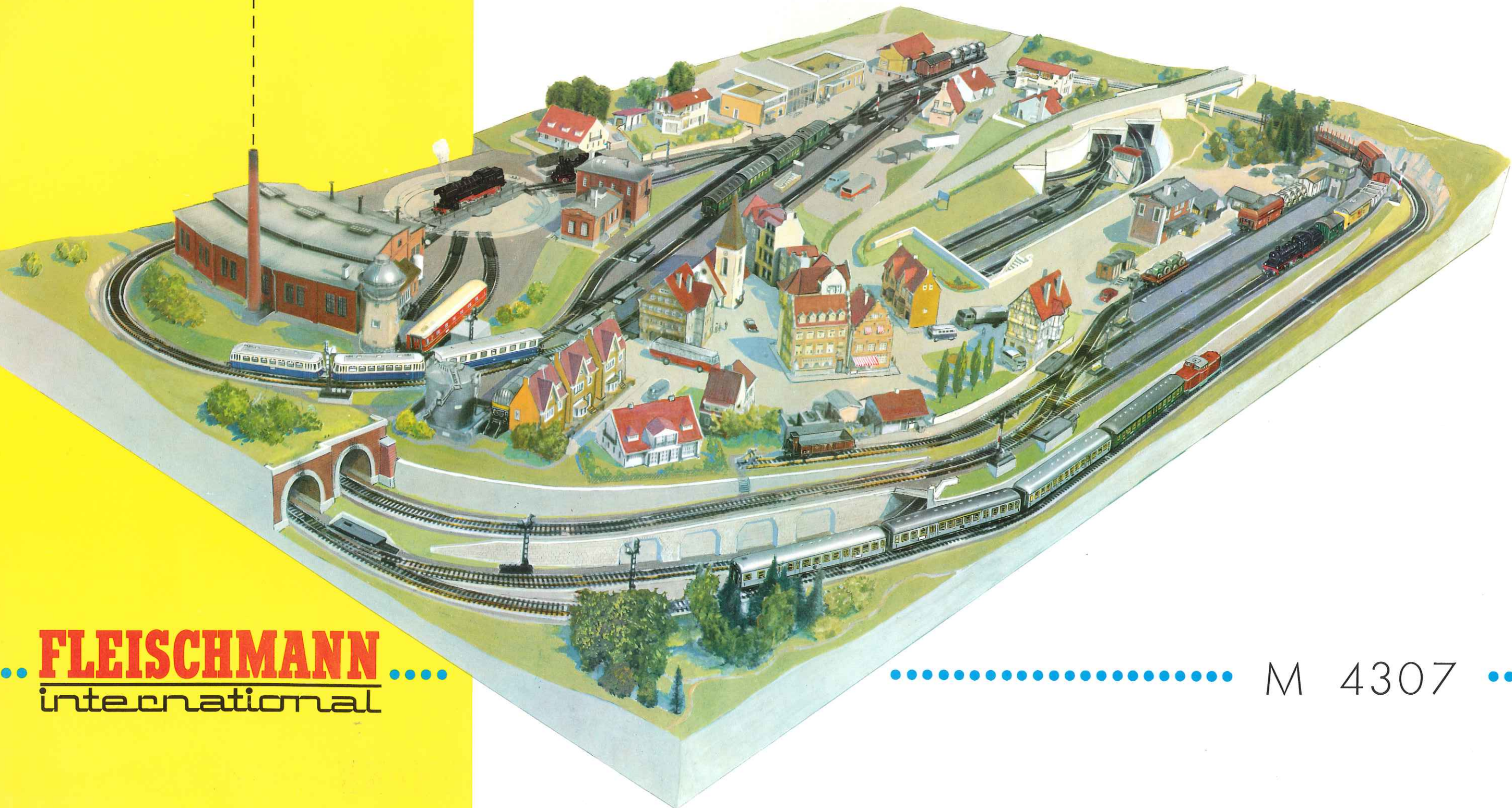

**FLEISCHMANN**  
international

M 4307



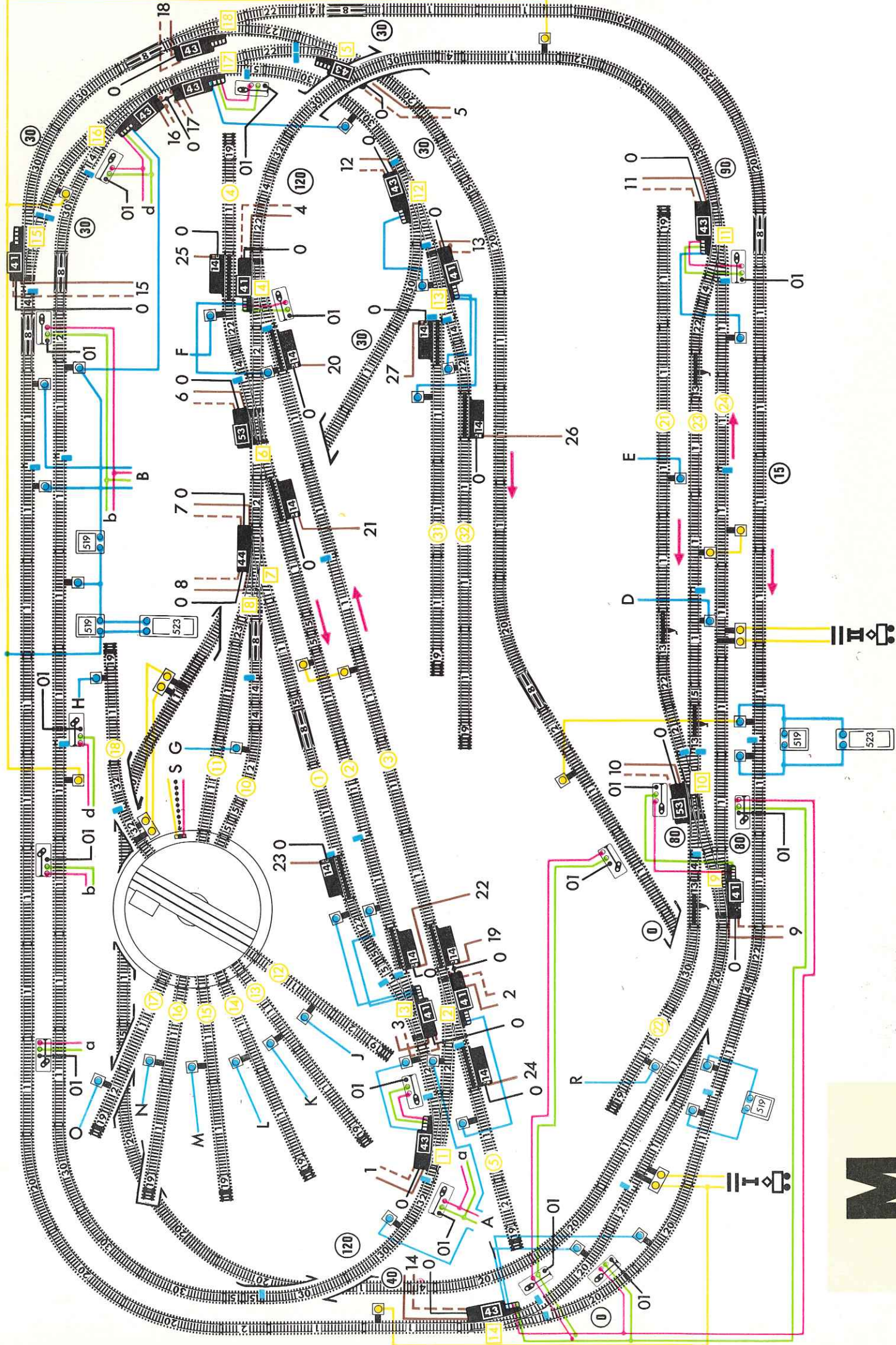

# M

## 4307

### PERFEKT

2,90 m x 1,65 m



Symb. N°	1	2	4	5	8	13	14
Art. N°	..00..00/2..00/4..00/5..10..00/2E..00/2EM						
	92 x	14 x	12 x	13 x	7 x	4 x	9 x
Symb. N°	19	20	21	22	23	30	32
Art. N°	..88..01..01/2..01 1/2..01 1/3..03..03 1/2						
	13 x	19 x	1 x	10 x	1 x	17 x	5 x
Symb. N°	41	43	44	53	58		
Art. N°	..24A..23A..26A..25A..80 60 62 78						
	3 P.	4 P.	1 x	2 x	1 x	4 x	38 x 43 x
Symb. N°							
Art. N°	507	515	516	517	519	521	523 524 1770
	6 x	2 x	8 x	3 x	4 x	1 x	2 x 1 x 5 x
Symb. N°							
Art. N°	1771	530	532	533	536	538	711 712
	10 x	18 x	2 x	21 x	1 x	2 x 103 x	1 x 1 x

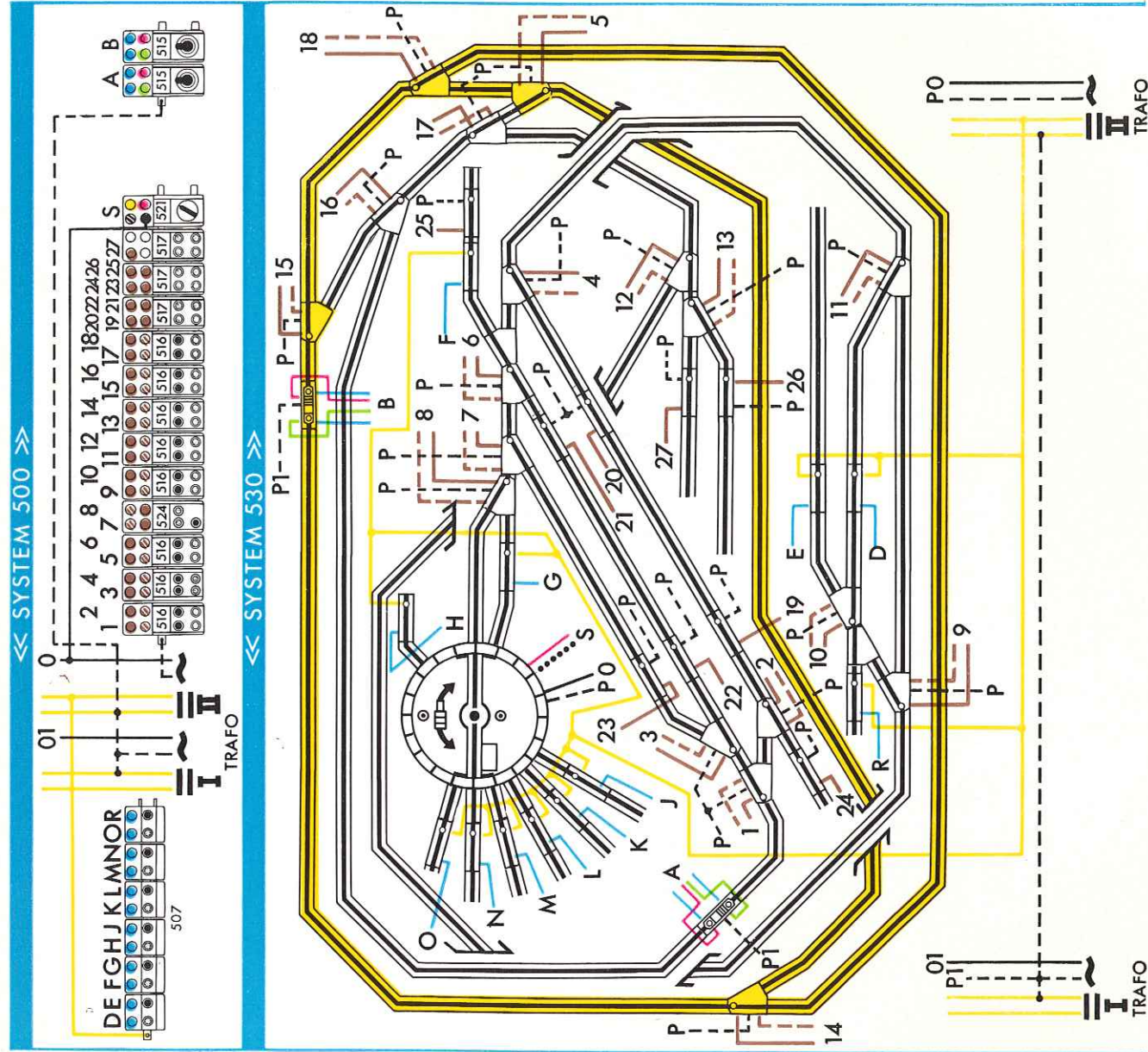

<< SYSTEM 500 >>

<< SYSTEM 530 >>

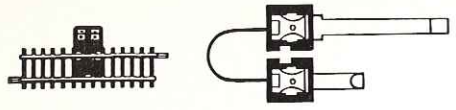

1700/2 K - Art. 60

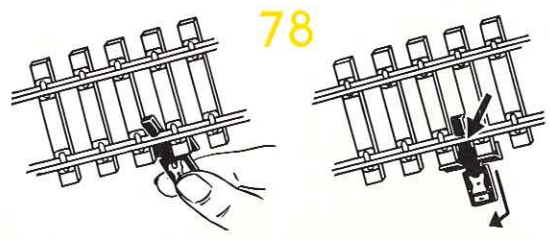
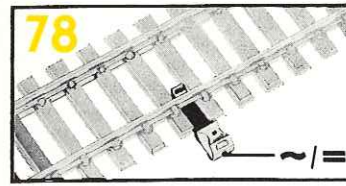
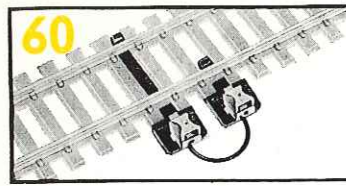

# VARIO SYSTEM

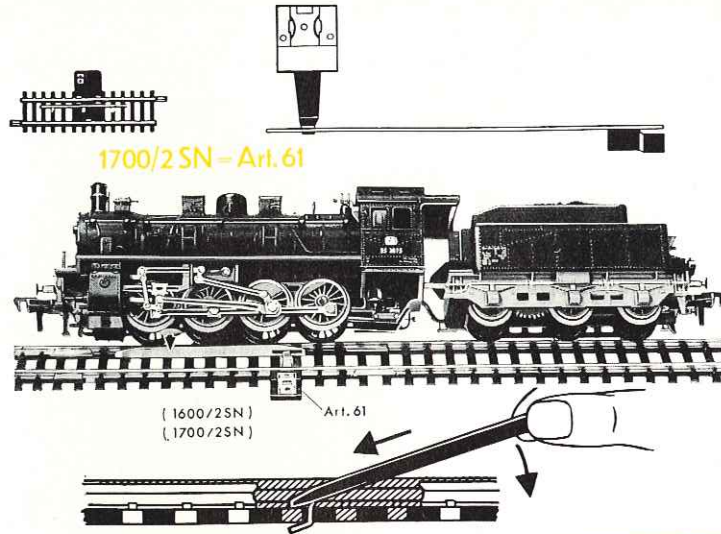
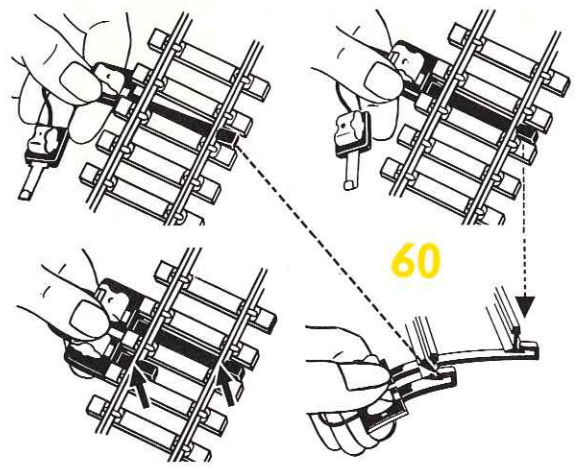

1700/2 SN - Art. 61

{ 1600/25N }  
{ 1700/25N }

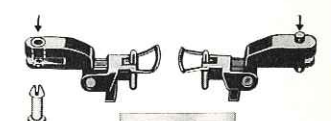
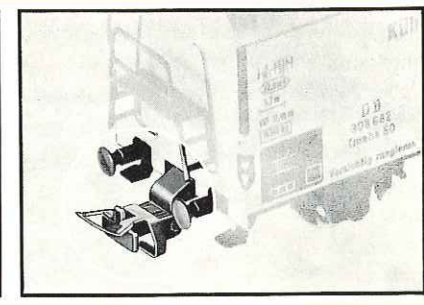
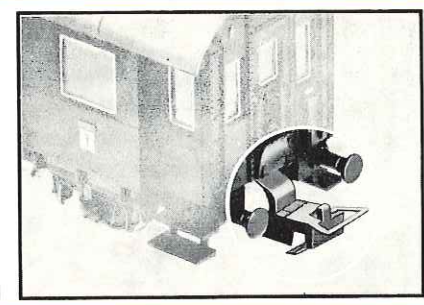
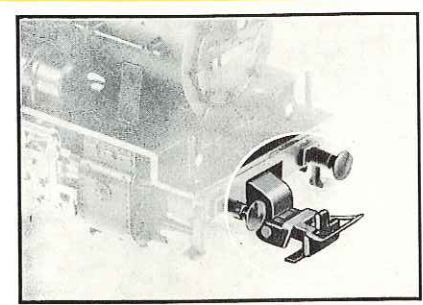
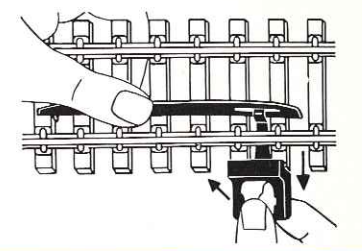
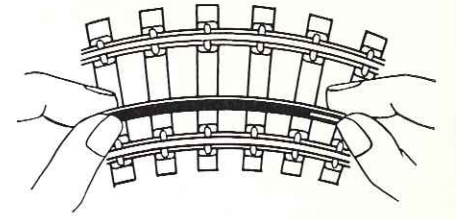
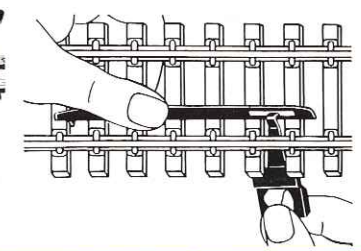
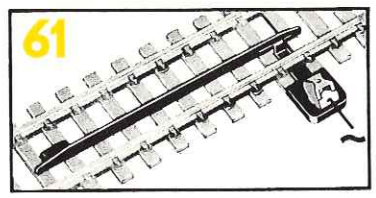

84S 84F 84Z

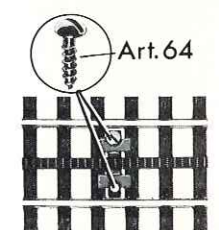
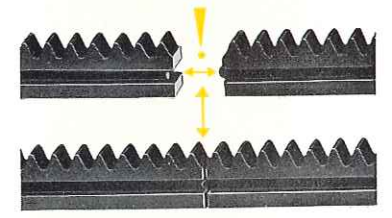
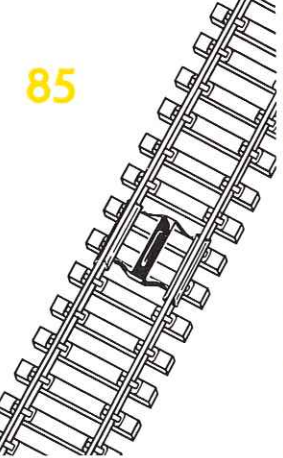
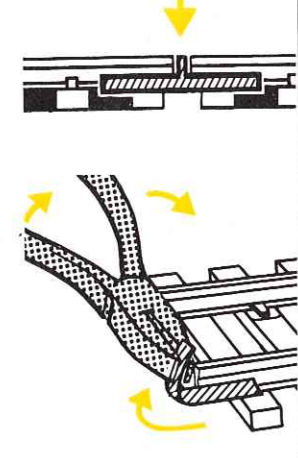
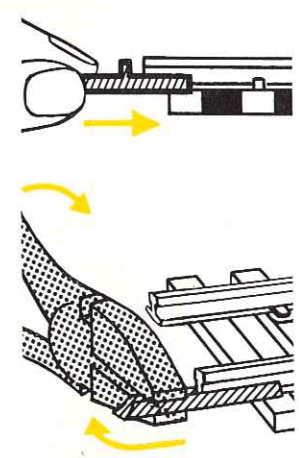
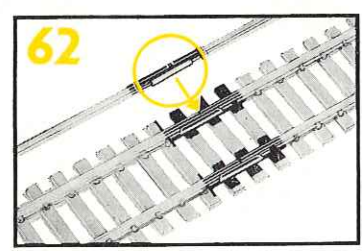

Art. 64

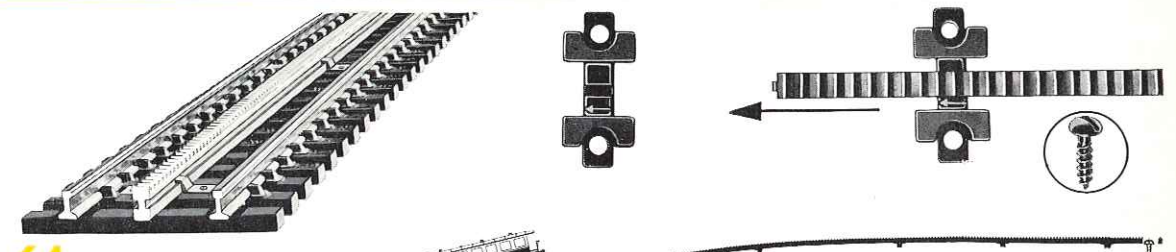

max. 35%

Art. 65

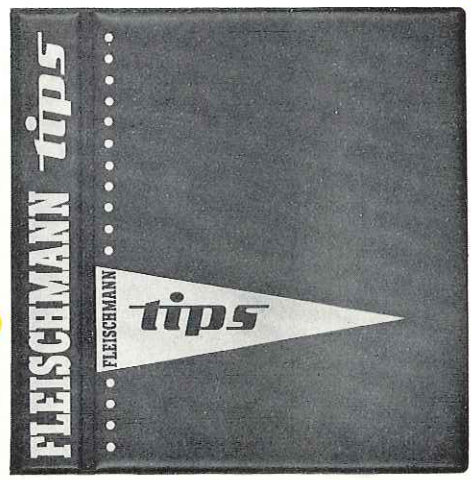
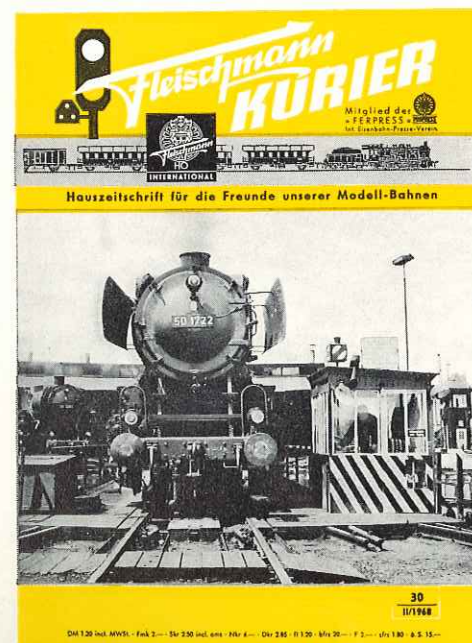
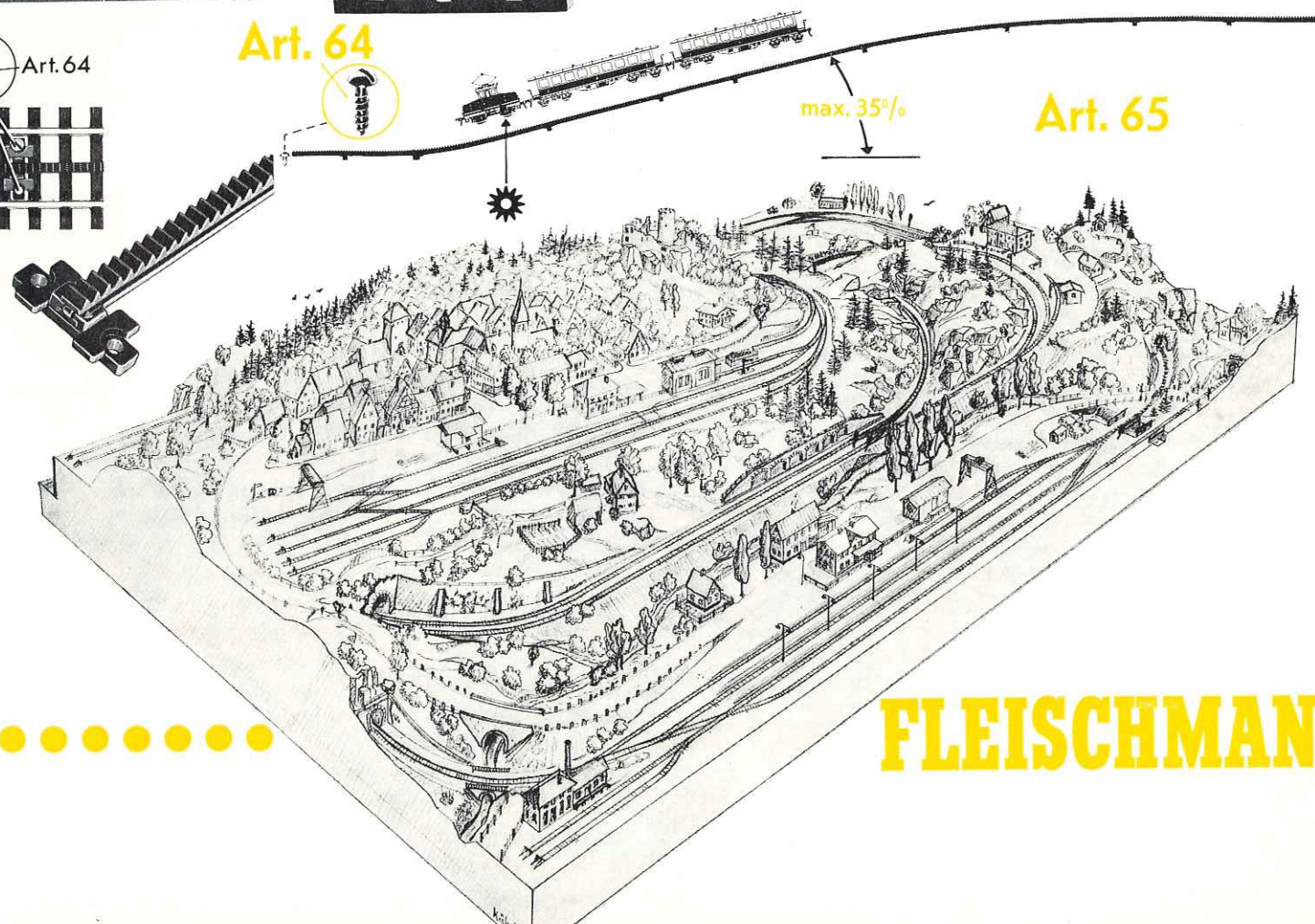

# FLEISCHMANN



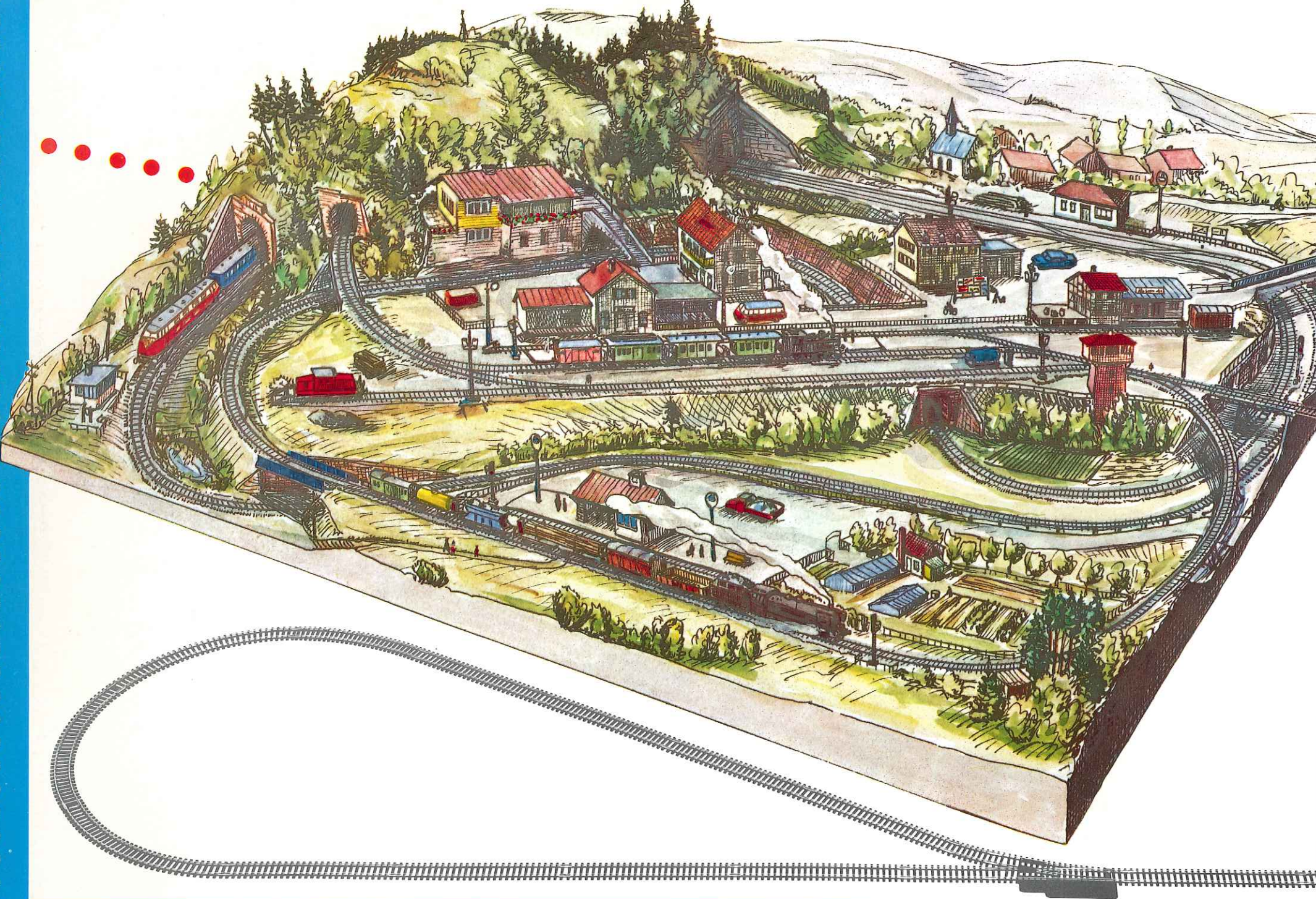

Automatische Anlagen mit Verdrahtung (Kehrschleifen, Gleis-Dreiecke, Abstell-Bahnhöfe)  
 Automatische banen met bedrading (keerlussen, raildriehoek, rangeerterreinen)  
 Réseaux automatiques avec câblage (boucles de retournements, triangles, gares de remisage)  
 Impianti automatici (racchetta, triangolo di binari, stazioni di deposito)  
 Maquetas automáticas con conexiones (bucles de retorno, triángulos de vías, estaciones apartadero)  
 automatic layouts with wiring (reversing loops, wyes, storage yards)  
 Automaattiradat (Paluusilmukat, raidekolmiot, sivuraideautomaattiradat)

Automatiska anläggningar med kopplingar (vändslingor, spårtrianglar, uppställningsbangårdar)

Automatiske anlæg med strømskema (køresløjfer, spor-trekanter, rangerbanegårde)

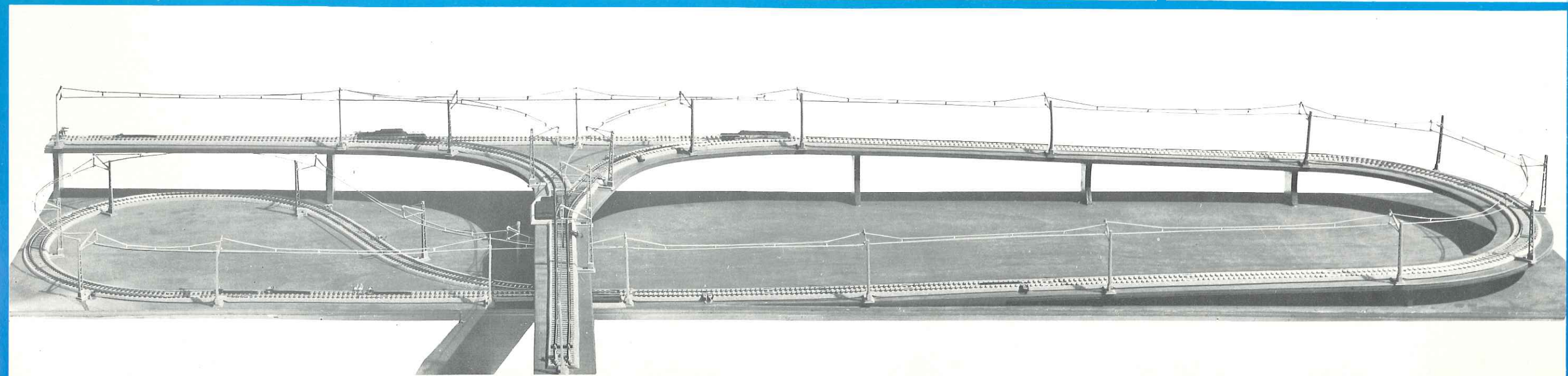

# FLEISCHMANN

## «550»

Dauer-Zug-Beleuchtung  
techn. Erklärung siehe Textheft

constante treinverlichting  
meer uitleg zie tekstboek

éclairage permanente des trains  
pour plus d'explications voir le texte

illuminazione costante dei treni  
particolarità tecniche vedi testo

continuous train-lighting  
technical instructions see text booklet

permanent tågbelysning  
tekn. förkl. se textheft

*Strahlende Freude auf Rädern!*

*Stralende vreugde op wielen*

*Joie rayonnante sur roues*

*Gioia irradiante dalle ruote*

*Fun on wheels*

*Strålende lyst på skinnerne*

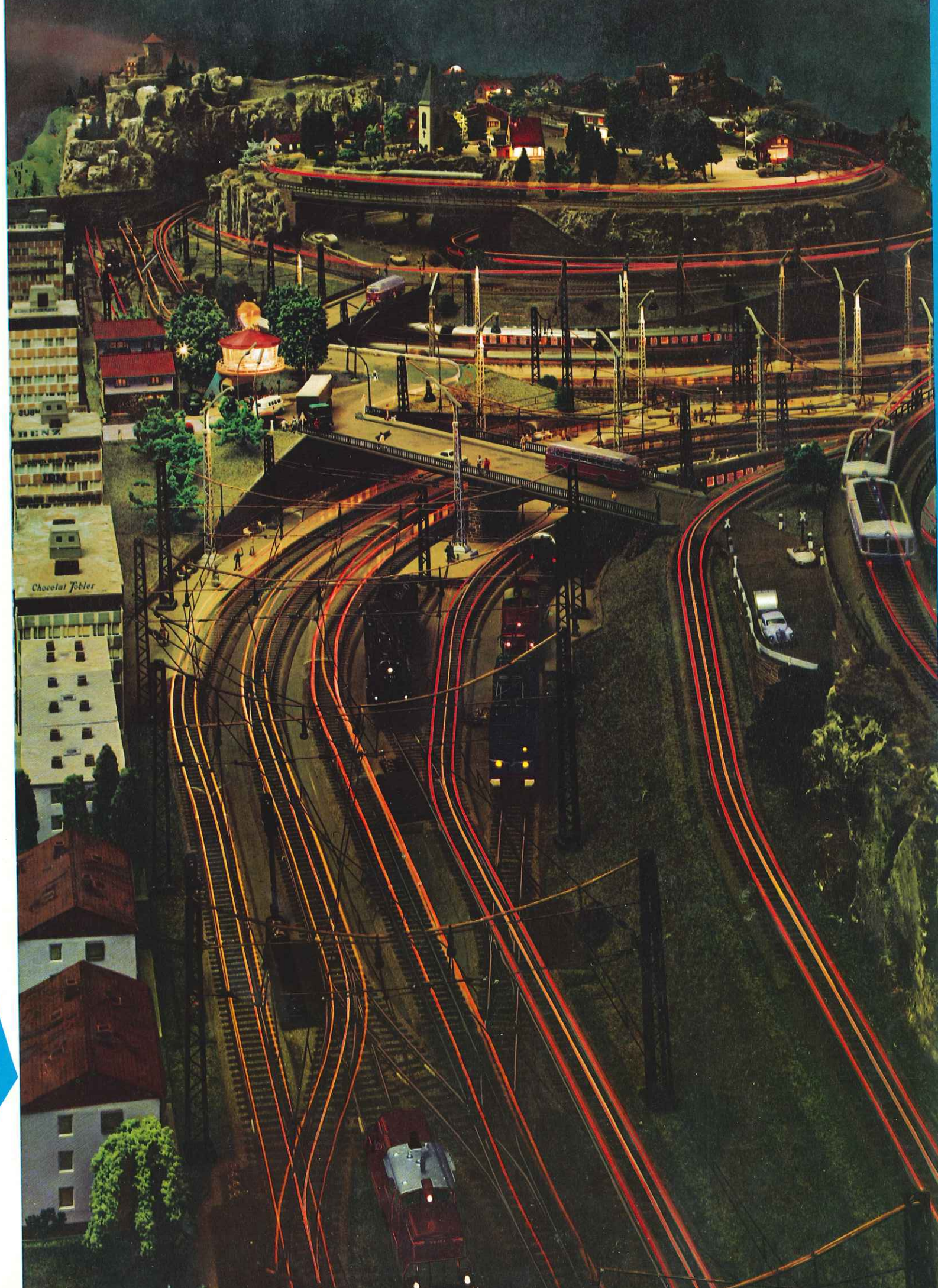



# FLEISCHMANN

international



**M**  
4400  
PERFEKT

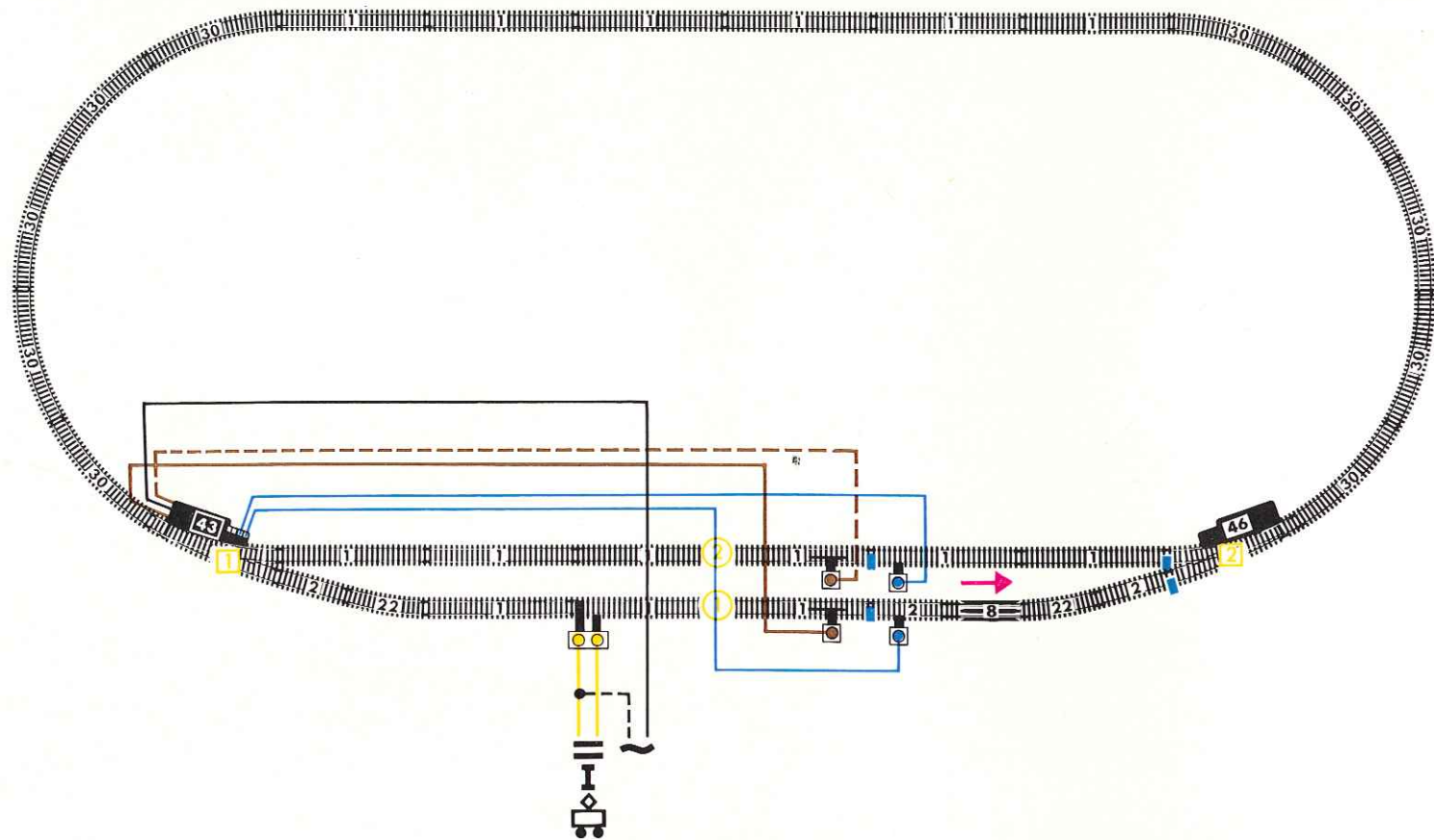

Symb. N°	1	2	8	22	30	43
Art. N°	· · 00	· · 00/2	· · 10	· · 01½	· · 03	· · 23 A
	15x	3x	1x	2x	10x	1x

Symb. N°	46					
Art. N°	· · 21	60	61	62	78	711 712
	1x	1x	2x	4x	2x	1x

2,00 m x 0,85 m

: 2  
 : 1  
 : 1

Symb. N°	1	2	8	22	30
Art. N°	· · 00	· · 00/2	· · 10	· · 01½	· · 03
	15x	3x	1x	2x	10x

Symb. N°	43					
Art. N°	· · 23 A	60	61	62	78	711 712
	1 P.	2x	4x	10x	2x	1x

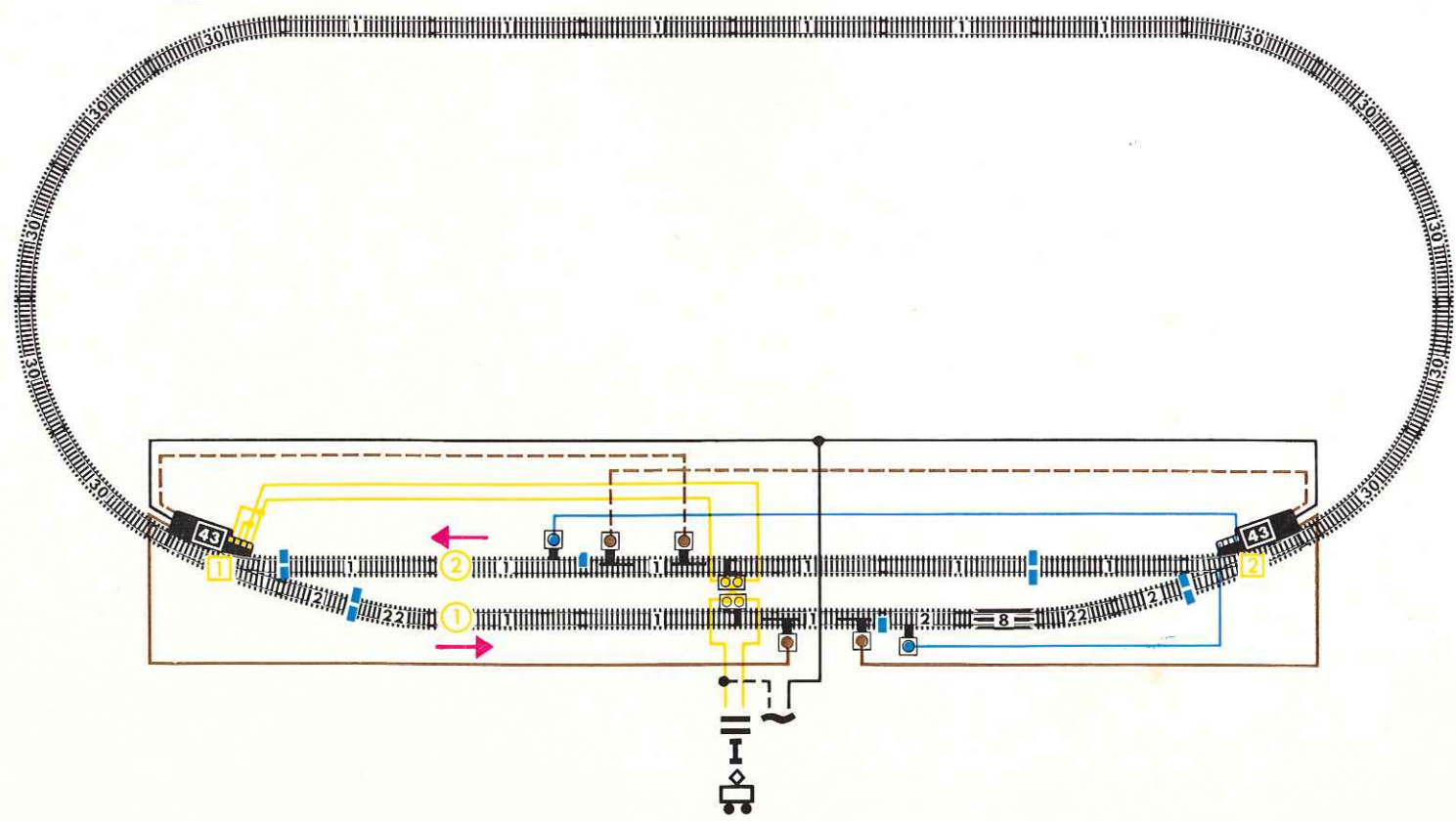

**M**  
4401  
PERFEKT

2,00 m x 0,85 m

: 2  
 : 1  
 : 1

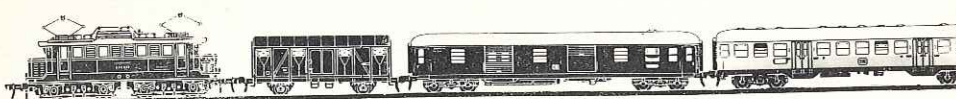

# FLEISCHMANN

international



**M**  
4402  
PERFEKT

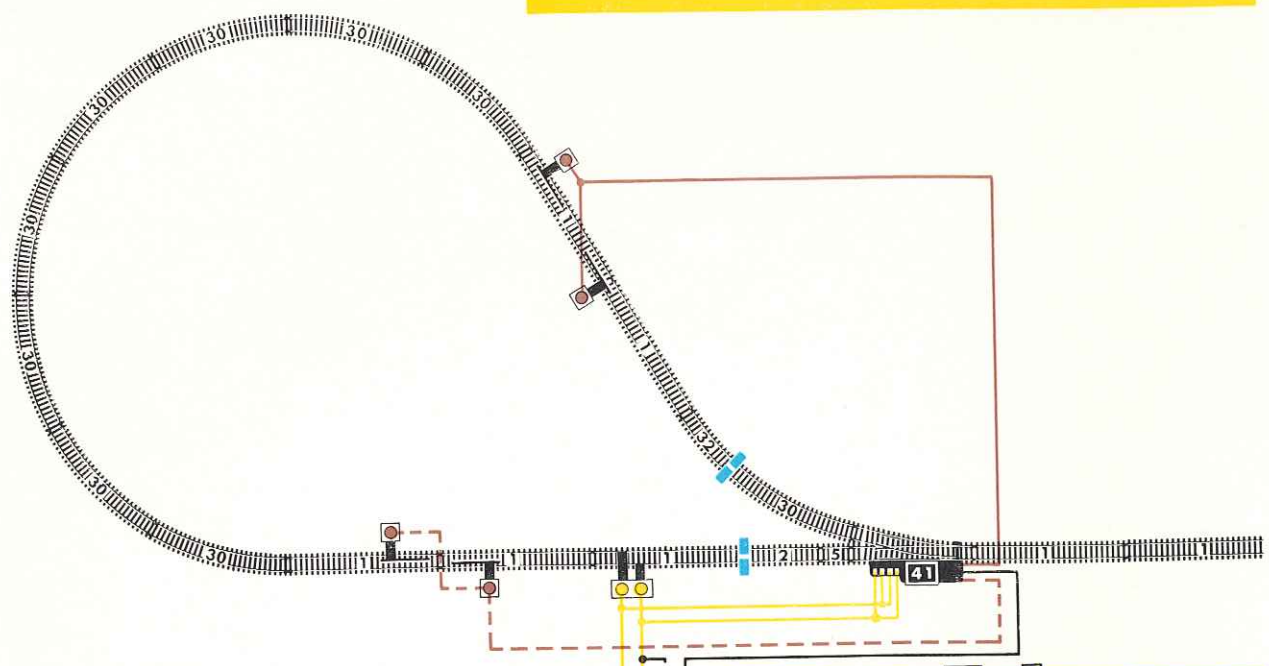

Symb. N°	1	2	5	30	32	41	60	61	62	I
Art. N°	..00	..00/2	..00/5	..03	..03 1/2	..24 A	1x	4x	4x	711 712
	7x	1x	1x	9x	1x	1x	1x	4x	4x	1x



**M**  
4403  
PERFEKT

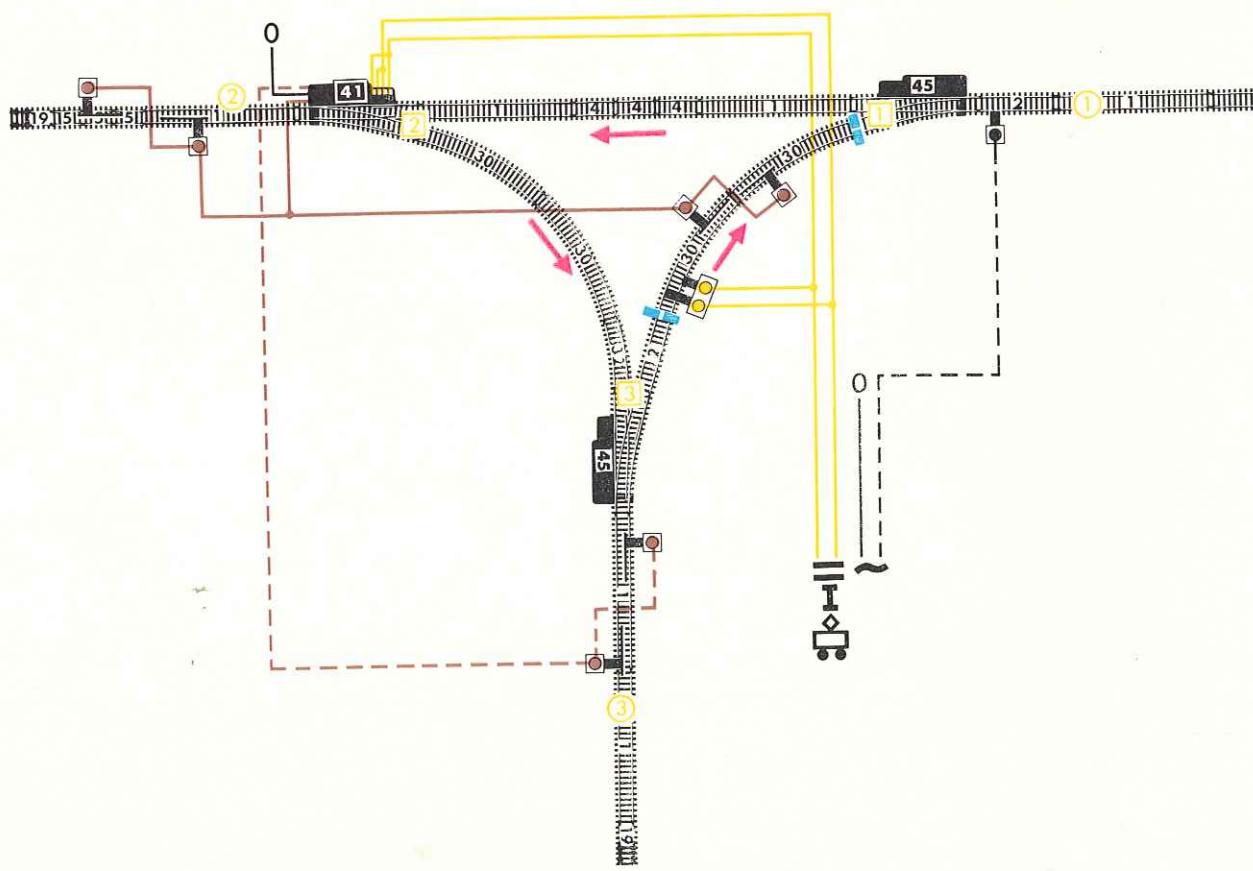

Symb. N°	1	2	4	5	19	30	32	41	45	60	61	62	78	I
Art. N°	..00	..00/2	..00/4	..00/5	..88	..03	..03 1/2	..24 A	..22	1x	6x	4x	1x	711 712
	6x	2x	3x	3x	2x	4x	1x	1x	1 P.	1x	6x	4x	1x	1x



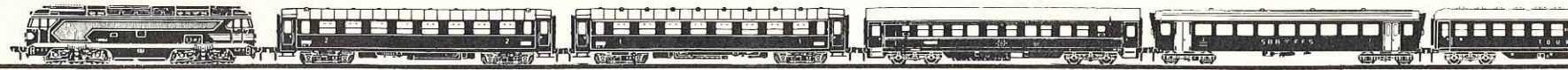

# FLEISCHMANN

international

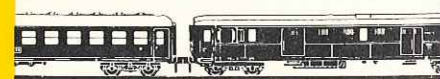

**M**

**4404**

**PERFEKT**

2,65m x 1,45m

- : 2-4
- : 1
- : 1

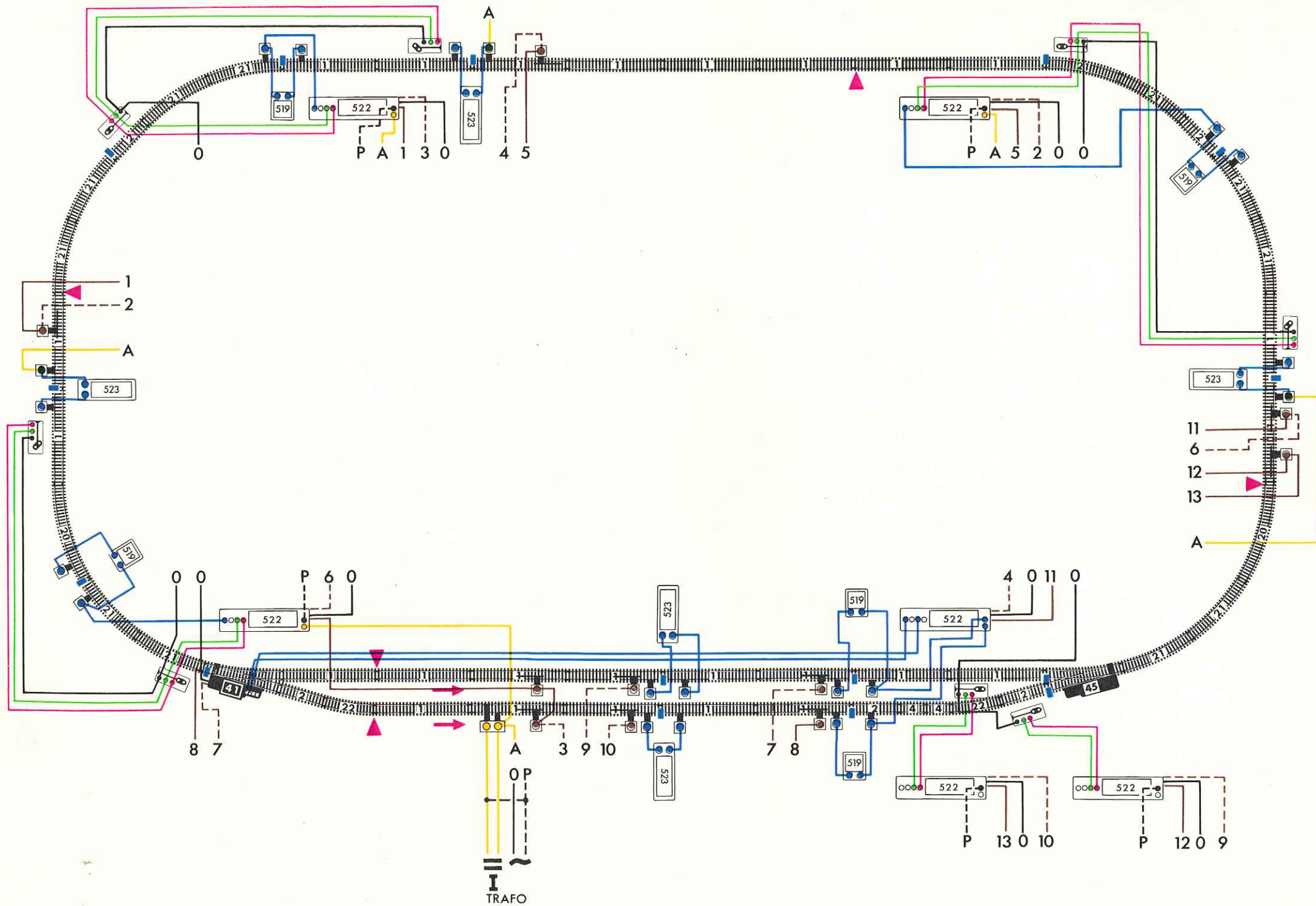

Symb. N°	1	2	4	20	21	22	41	45										<b>I</b>
Art. N°	.. 00	.. 00/2	.. 00/4	.. 01	.. 01/2	.. 01½	.. 24 A	.. 22	60	61	62	78	519	522	523	1770	1771	712
	25x	5x	2x	2x	12x	2x	1xY	1xN	1x	10x	15x	20x	5x	6x	5x	3x	5x	1x

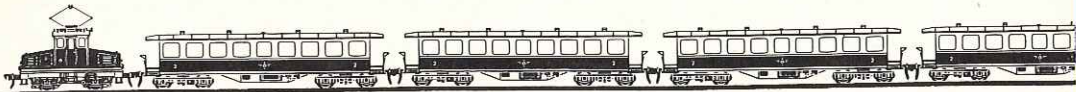

# FLEISCHMANN international



**M**  
4405  
PERFEKT

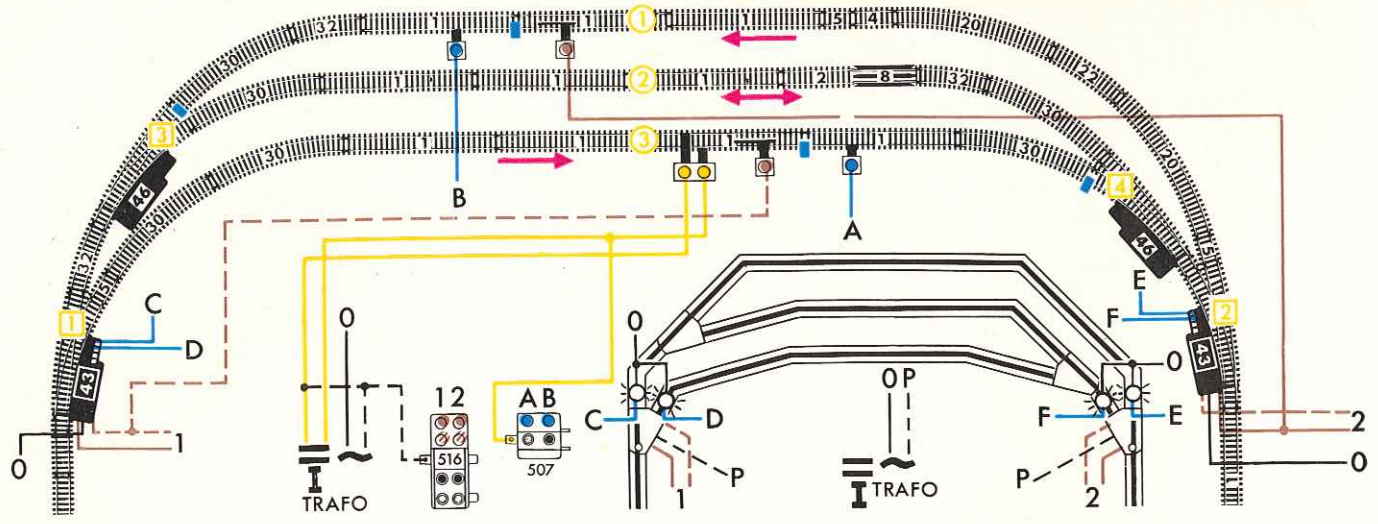

Symb. N°	1	2	4	5	8	20	22	30	32	43	46					507	516
Art. N°	00	00/2	00/4	00/5	10	01	01½	03	03½	23 A	21	60	61	62	78	507	516
	12x	1x	1x	3x	1x	2x	1x	6x	3x	1 P.	1 P.	1x	2x	4x	2x	1x	1x

Symb. N°				<b>I</b>
Art. N°	530	536	538	711 712
	2x	2x	16x	1x

**M**  
4406  
PERFEKT

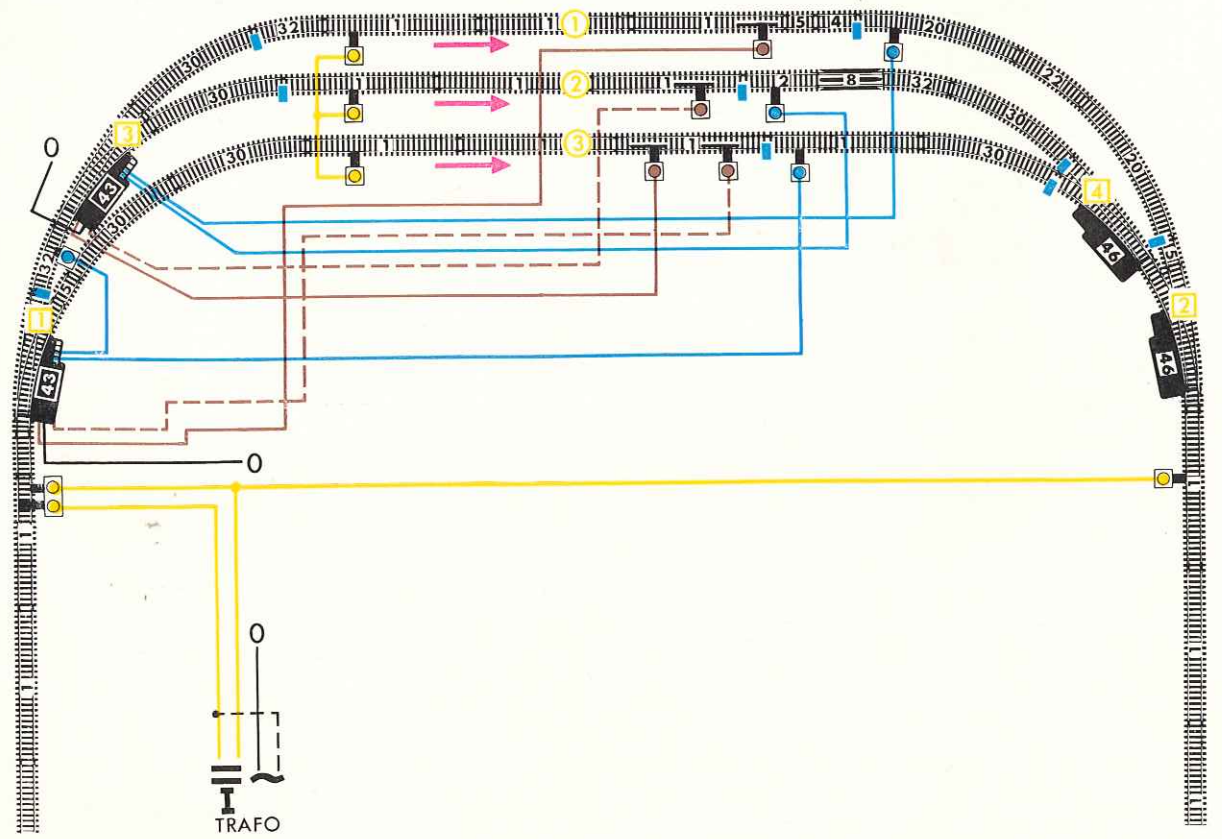

Symb. N°	1	2	4	5	8	20	22	30	32	43	46					<b>I</b>
Art. N°	00	00/2	00/4	00/5	10	01	01½	03	03½	23 A	21	60	61	62	78	711 712
	15x	1x	1x	3x	1x	2x	1x	6x	3x	2x	2x	1x	4x	9x	8x	1x

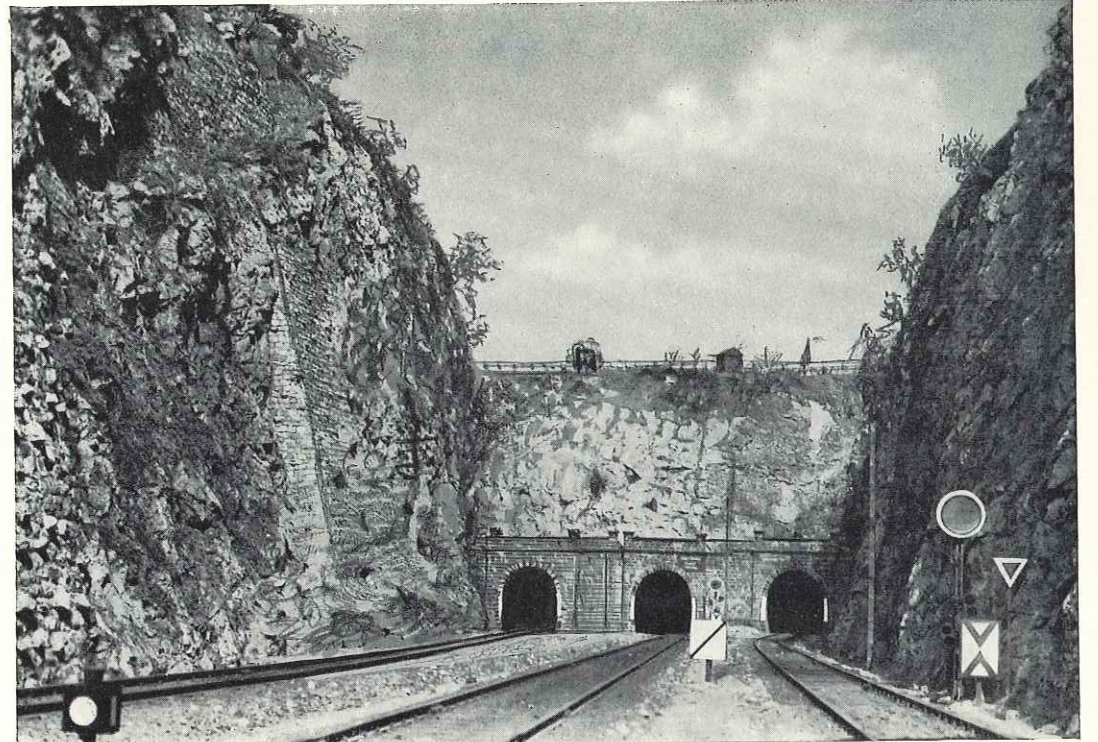

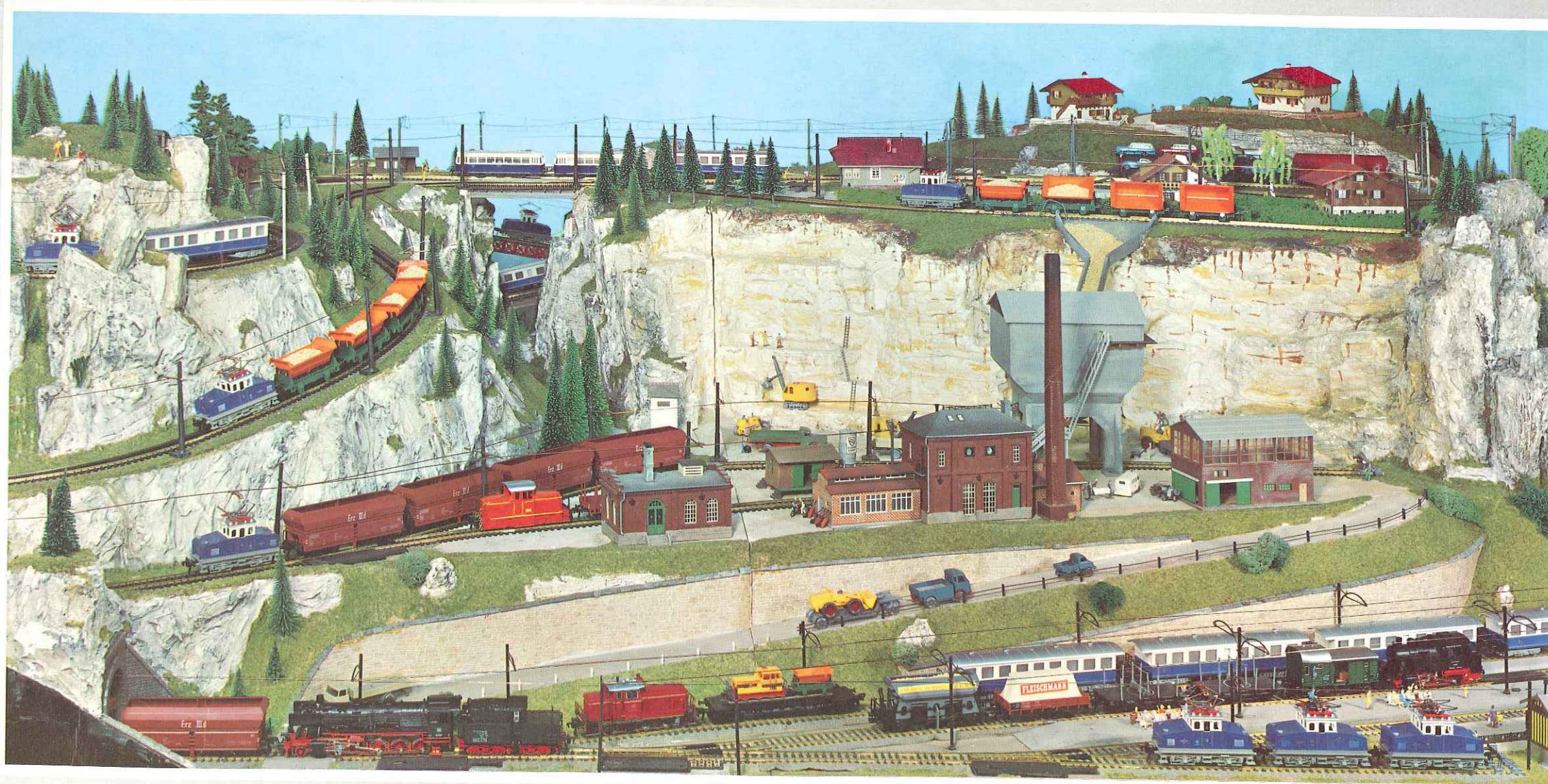

# FLEISCHMANN

# M4

